



ESAB 2023 WELDING & CUTTING CATALOG

# WELDING & CUTTING CATALOG 2023 EDITION



**VICTOR**  
AN ESAB BRAND

**THERMAL  
DYNAMICS**  
AN ESAB BRAND

**TWECO**  
AN ESAB BRAND

**ARCAIR**  
AN ESAB BRAND

As fabricators and fabricators' friends, we do some pretty epic work. And none of it would be possible without each and every one of us – the welders,

**SKYSCRAPERS.** the distributors,  
**MUSCLE CARS.** the engineers,  
**WIND TURBINES.** the tools of  
**OIL RIGS.** the trade.

Across the welding and fabrication world, the skills we have and the everyday work we do varies greatly, but our commitment to that work and to how fabrication moves the world forward is a constant that keeps us all reaching for more.



# INDEX

## PRODUCT CATEGORIES

ARC WELDING EQUIPMENT .....	7
GAS EQUIPMENT .....	93
ARC GOUGING & EXOTHERMIC CUTTING .....	173
MANUAL PLASMA .....	205
PPE & ACCESSORIES .....	223

### VISIT OUR WEBSITE FOR MORE INFORMATION ON:

- WELDING AUTOMATION
- CUTTING AUTOMATION
- MIG GUN CONSUMABLES
- FILLER METALS
- STEEL INDUSTRY PRODUCTS



### FIND A DISTRIBUTOR

Looking for a product or ready to purchase?  
Visit [esab.com](http://esab.com) to find an ESAB distributor in your area.



### ESAB UNIVERSITY ONLINE

Web-based training content is available for free! Browse our course material online or contact our training team to book onsite training at our facilities or yours.

Visit [training.esabna.com](http://training.esabna.com) to learn more.

### STAY CONNECTED



[esab.com](http://esab.com)



[facebook.com/esabna](https://facebook.com/esabna)



[@esabweldingcutting](https://instagram.com/esabweldingcutting)



[twitter.com/esabglobal](https://twitter.com/esabglobal)



[linkedin.com/company/esab](https://linkedin.com/company/esab)



[youtube.com/esabweb](https://youtube.com/esabweb)

Stay updated by joining our e-news mailing list at [esab.com/about/news](http://esab.com/about/news).

# OUR BRAND FAMILY.

ESAB's strong, diversified portfolio of products and offerings is unmatched in our industry. This enables us to better serve our customers and their needs and shape the future of welding and cutting together.



## **The World Leader in the Production of Welding and Cutting Equipment and Consumables.**

Our innovative, world-renowned equipment and solutions are developed with input from our customers and built with the expertise and heritage of a global manufacturing leader.



## **The Leader in Arc Welding Accessories and MIG Guns**

Tweco is the industry leader in arc welding accessories, which includes Tweco MIG guns a popular choice among professional welders.



## **The Leader in Gas Equipment**

Victor Gas Equipment's tradition of unparalleled safety, performance and reliability remains a cornerstone of the brand.



## **The Recognized Inventor and Leading Producer of Hardfacing Alloys**

Stoody is the leader in hardfacing technology and high alloy filler metals. We formulate products that maximize uptime, extend life cycle and reduce operating cost.



## **The Standard in Plasma Cutting Performance.**

Thermal Dynamics invented the modern plasma electrode, created the lightweight manual plasma cutter category and has redefined high-precision productivity.



## **The Recognized Inventor of Arc Gouging and Exothermic Cutting**

Arcair is a world leader in air carbon-arc gouging and exothermic cutting products.



**ESAB University** is your online learning destination for welding and fabrication technology. Make personalized playlists of your favorite resources including videos, blogs, articles, webinars and more.

Find out more at [esab.com/esab-university](https://esab.com/esab-university).



## **TURBOTORCH**

AN ESAB BRAND

### **The Leader in Brazing and Soldering**

TurboTorch is the leading provider air fuel brazing and soldering products, which includes portable welding torches, oxy-acetylene gauges and more.



### **The Most Trusted Name in Aluminum Welding**

AlcoTec is the world's largest producer and the foremost expert in the production of aluminum welding wire.

## **EXATON**

AN ESAB BRAND

### **Premium Stainless Steel and Nickel Alloys**

Exaton (formerly Sandvik Welding Operations) specializes in crafting the highest-quality filler metals with unwavering consistency for welding stainless steel and nickel alloys in the most-demanding environments.



### **The Leader in Orbital TIG Welding**

Arc Machines, Inc. delivers the world's broadest and most advanced range of automated orbital tube and pipe TIG welding equipment and application.



# THIS IS OUR PLEDGE.

We are committed to putting customers first. The **Iron Clad Pledge** is our promise to keep our customers' complete satisfaction at the forefront of everything we do. Our pledge is centered around:

- 100% Customer Satisfaction Program
- ESAB's extensive product warranties
- Customer-focused business practices

## 100% SATISFACTION PURCHASE PROTECTION.

We offer a 100% satisfaction guarantee on eligible products. If you are not satisfied with your new ESAB product, a credit or replacement will be issued. Should you need assistance, call 1-800-426-1888 and select Option 1 to be connected with a Customer Care representative. Count on ESAB to do whatever it takes to make it right for you.

## THE BEST PRODUCT WARRANTIES IN THE INDUSTRY.

ESAB is a global supplier to the welding and cutting industry. We are committed to providing our customers with reliable, high-quality products. To keep this commitment, we offer solid warranties across the entire ESAB family of brands, including:

- Arc equipment and accessories
- Cutting and gouging equipment
- Filler metals
- PPE

## LIFETIME WARRANTY ON EDGE™ 2.0 REGULATORS.

We have new and expanded warranties on many Victor® products, including a **LIFETIME Warranty** on all EDGE 2.0 regulators. Victor SR Series regulators – along with 100 and 300 Series torches and handles featured in our most popular outfits, such as Journeyman®, Journeyman Select, Performer® and Contender® – now have warranties extended **from 5 years to 10 years** on parts. Additionally, all Victor G Series regulators and 400 Series torches and handles, found in our Medalist® outfits, now have warranties extended **from 5 years to 7 years** on parts.

## CUSTOMER-FOCUSED BUSINESS PRACTICES.

ESAB has standard work processes designed to put customer needs as our top priority. Processes include:

- Voice-of-the-Customer that collects customer input early in the design process to ensure products meet or exceed customer needs.
- Support teams that execute robust, repeatable processes that consistently meet or exceed customer expectations.
- Responsive Customer Care representatives to aid customers with questions and to promote problem resolution.
- Dedication to a constant focus on quality and speed to continually earn our customers' business.

Learn more at [esab.com/support/warranty](https://esab.com/support/warranty).





100% SATISFACTION IS OUR **PROMISE TO YOU.**

**Our pledge:** To create the best products and give customers complete buying confidence with our 100% Satisfaction Guarantee and the most extensive warranties, including a new lifetime warranty on all Victor® EDGE™ Series 2.0 regulators.

Learn more at [esab.com/support/warranty](https://www.esab.com/support/warranty).

# // ARC WELDING EQUIPMENT







## CONTENTS

Arc Welding Processes.....	10
<b>STICK MACHINES</b>	
Rogue ES 130i PRO and ES 180i PRO .....	13
Renegade™ ES 300i .....	14
Ruffian™ ES 150G EDW.....	15
<b>TIG MACHINES</b>	
ET 141i AC/DC .....	17
ET 186i AC/DC .....	18
Rogue ET 200iP PRO .....	19
Rogue EM Series (coming soon) .....	20
Renegade Volt (coming soon) .....	21
Renegade™ ET 300iP.....	22
ET 301i AC/DC .....	23
ET 301i AC/DC Accessories.....	24
<b>MIG MACHINES</b>	
ESAB EM 210.....	26
<b>MULTI-PROCESS MACHINES</b>	
Fabricator® 141i.....	27
ESAB EMP 210.....	28
Rebel™ EMP 205ic AC/DC & EMP 215ic.....	31
Rebel™ EMP 235ic & EMP 285ic .....	32
Rebel™ Series Accessories.....	33
Warrior™ 300i CC/CV.....	35
Warrior™ 400i MV & Warrior 500i .....	36
Warrior™ 400i MV & Warrior 500i Accessories.....	37
Warrior™ 750i ARCAIR.....	39
Warrior™ 500i Multiple Operator Systems .....	40
Warrior™ EDGE 500 CX .....	41
Aristo® 500ix.....	43
Aristo® MIG 4004i Pulse .....	44
Aristo® MIG 5000i/U5000i .....	45
Aristo® MIG 4004i Pulse & 5000i/U5000i Accessories.....	46
<b>WIRE FEEDERS</b>	
MobileFeed 201AVS .....	48
Warrior™ Feed 404HD.....	49
Warrior™ YardFeed 200.....	49
Ultrafeed 404HD.....	50
Robust Feed AVS .....	51
Robust Feed PRO .....	52
Robust Feed Pulse/U6/U82 .....	53
Wire Feeder Control Panels.....	54
Aristo® U8 <sub>2</sub> Plus Controller .....	55
Aristo® SuperPulse™ .....	56
Wire Feeder Accessories.....	57
MiniBoom Assembly .....	58
Balanced Boom Assembly .....	58

## MIG GUNS & TIG TORCHES

EASY FIND GUIDE - MIG Gun Selection Guide.....	59
Tweco Spray Master 250 Amp MIG Gun.....	61
Tweco Spray Master 350 Amp MIG Gun.....	61
Tweco Spray Master 450 Amp MIG Gun.....	62
Tweco Spray Master Velocity2 V250 Amp MIG Gun .....	62
Tweco Spray Master Velocity2 V350 Amp MIG Gun .....	63
Tweco Spray Master Velocity2 V450 Amp MIG Gun .....	63
Tweco Classic No. 1 180 Amp MIG Gun.....	64
Tweco Classic No. 2 200 Amp MIG Gun.....	64
Tweco Classic No. 3 300 Amp MIG Gun.....	65
Tweco Classic No. 4 400 Amp MIG Gun.....	65
Tweco Classic No. 5 500 Amp MIG Gun.....	66
Tweco Velocity2 Classic No. 1 180 Amp MIG Gun .....	66
Tweco Velocity2 Classic No. 2 200 Amp MIG Gun .....	67
Tweco Velocity2 Classic No. 3 300 Amp MIG Gun .....	67
Tweco Velocity2 Classic No. 4 400 Amp MIG Gun .....	68
Tweco Velocity2 Classic No. 5 500 Amp MIG Gun .....	68
Tweco Fusion 180 Amp MIG Gun .....	69
Tweco Compact Eliminator 250 Amp MIG Gun .....	69
Tweco Compact Eliminator 450 Amp MIG Gun .....	70
Tweco Supra XT SEHD 400 Amp MIG Gun.....	70
Tweco Velocity2 Supra XT VSEHD 400 Amp MIG Gun .....	71
Tweco Flux-Cored SEFC 450 Amp MIG Gun .....	71
Fusion Pro™ 7W & 9W Water-Cooled MIG Gun .....	73
PullMaster2™ Air-Cooled MIG Gun .....	74
MXH 315 PP Air-Cooled MIG Gun .....	75
MXH 420W PP Water-Cooled MIG Gun .....	76
Tweco Standard 600 Amp Water-Cooled MIG Gun .....	77
ESAB ST Water-Cooled MIG Guns .....	77
Tweco Spool Guns .....	78
ESAB ST-23A Spool Gun .....	78
Tweco® Centrovac Fume Extraction MIG Guns .....	79
SR-B Family .....	80

## ARC ACCESSORIES

Remote Controls .....	81
Twist Lock Connectors.....	82
Interconnection Cables .....	82
Electrode Holders.....	83
Ground Clamps .....	84
Ground Clamp Accessories .....	87
Switchable Magnetic Work Holding Products.....	88
Cable Lugs .....	89
Cable Connectors .....	91
Splicers, Terminals and Accessories.....	92

## Arc Welding Processes

### Gas Metal Arc Welding (GMAW, MIG)



This most flexible metal joining process involves an arc established between the workpiece and a wire electrode, which is continuously fed by a wire feeder through a torch.

The arc continuously melts the electrode to form the weld puddle.

An appropriate gas or gas mixture shields the weld area from atmospheric contamination.

The GMAW process has the advantages of high deposition rates, speed, excellent weld quality, minimal distortion of the workpiece, and no stub loss.

GMAW applications include several distinct process variations. Selection depends largely on the workpiece thickness and welding position:

#### Short Circuiting (Short Arc, Dip Transfer)

Involves a small fast-freezing weld puddle. Metal is transferred from the electrode to the puddle by repeated short circuits. Small diameter wires are used and the process operates at low currents and voltages. Short arc is used for welding thin gauge metals in all positions and for vertical and overhead welding of heavier sections.

#### Spray Arc

Electrode metal is transferred to the weld puddle as discrete droplets. Deposition rate is high and there is little or no spatter. With solid wire, the technique is used for 1/8 in. (3.2 mm) and thicker workpieces and for downhand welding.

#### Pulsed Spray Arc

The welding current is varied rapidly between a high and a low value. Metal is transferred to the work only during the high current period. The high peak current provides excellent arc stability. The period of low current maintains the arc and reduces the average current, making it possible to weld thinner gauge materials and to weld in all positions using larger sized wire electrodes than otherwise possible.

#### Cored Wire (FCAW, MCAW)

The electrode is fabricated from strip, enclosing a core of flux and metal which protects and refines the weld puddle and controls bead shape. Some cored wires can be used without external shielding gas. Smaller diameter wires can be used for all position welding. The addition of fluxing, alloy and slag-forming materials often allows high deposition rates, higher welding speeds and improved all-position capability compared with solid wires. This makes cored wire the material of choice in many high-production applications.

### Shielded Metal Arc Welding (SMAW, Stick)



In this first practical arc welding process, the arc is established between a wire rod and the workpiece. The rod is coated with materials, which generate a gas and form a slag to protect the weld puddle and the solidifying weld metal from the atmosphere.

The coating may also supply alloying and refining ingredients, and the slag may help shape the weld bead, especially in vertical and overhead applications.

Electrodes are available for welding most carbon, low alloy, and stainless steels, some non-ferrous metals, and a wide range of maintenance and repair applications.

Light-duty work is often done with AC power from low cost transformers; production work usually involves DC power from heavy-duty rectifiers.

### Gas Tungsten Arc Welding (GTAW, TIG)



Introduced by ESAB, the GTAW process produces welding heat from an arc between a non-consumable tungsten electrode and the workpiece. An inert gas, usually Argon, shields the arc and the workpiece.

Welding consumables, if used, are added separately. Because the process uses totally inert

shielding gas, welds of the highest quality are produced, and almost any metal can be welded.

### Additional Technical Information

ESAB Technical Service Representatives are available to answer your questions. We also recommend that you take advantage of a series of handbooks published by ESAB which provide excellent guidance on the use of the arc welding processes.

In addition, there are references from other sources which can be very helpful in achieving the best possible results.

Call ESAB at 1.800.ESAB.123 to find out more.

# GO ROGUE. OR TURN RENEGADE™.

When you need performance, portability and power – or even more power, performance and portability ... go **Rogue** and turn **Renegade**. These TIG/Stick inverters deliver professional-grade results with High Frequency (HF) TIG arc starts, pulsed TIG outputs and other rule-defying features.

## ROGUE ET 200iP PRO

Never before has so much performance been available at such an attractive price point for taking on everything from quick repairs to code-quality pipe work.

Rogue differentiators start with a built-in solenoid valve and 200A of welding power – 40A more than any other welder in its class. It continues with HF arc starts, upslope/downslope control, a pulsed TIG range of 0.2–500 Hz and outstanding Stick performance with all electrodes (including 6010). To top it off, all this comes in a 21.1-lb. package with dual-voltage 120V/230V input for go-anywhere flexibility.

## ROGUE ES 130i AND 180i PRO

For those who focus on Stick projects, choose the Rogue ES 130i or 180i PRO. They offer all the Stick benefits of the 200iP PRO, plus Live TIG arc starts for TIG welding.

Generous ready-to-weld TIG and Stick accessory package.



# ROGUE

GO PUL

Pulsed TIG reduces heat input, narrow puddle control and increases travel speed on steel, thin metal, delicate or h

Renegade ET 300iP  
for HF TIG/Stick.



Water-cooled package weighs 59.3 lbs.,  
converts to an air-cooled system in  
minutes without tools.

Renegade ES 300i  
for Stick/Live TIG.

## TURN RENEGADE

Renegade ET 300iP weighs 37 lbs. yet offers a 300A output at 40% duty cycle, HF arc starts, a pulsed TIG range of 0.1–1,000 Hz and a peak amperage pulse duration adjustable between 10 and 90%.

Renegade can also weld with Stick electrodes up to 1/4 in. As a next-generation inverter, its Stick performance is enhanced by built-in intelligence for optimizing starts and stops with greater control over arc stability for less spatter. For those who focus on Stick welding and only need Live TIG arc starts, ESAB offers the Renegade ES 300i.

## ON THE GO

Renegade connects to 230V 1-ph power and 230V to 480V 3-ph power with auto-sensing functionality and no rewiring required. A compact format, multi-handle design and integrated cable management system make it easy to carry and bring to any job site.



## USED!

ows the weld profile, can improve  
speed – all benefits for stainless  
eat-sensitive applications.

# RENEGADE™



VIDEO

## ROGUE ES 130i PRO and ES 180i PRO Portable DC Stick and Stick/TIG Welding Systems



STICK MACHINES



- Dual voltage input supply – flexibility to use any place on single phase plug
- Superior Arc characteristics – smooth and stable performance (including special mode for stick 6010)
- Generator Compliant – suitable for use with generators. (7kW recommended)
- Easy to Use – set the welding current and weld with excellent results
- Practical Design – makes the power source easy to carry which enables use at almost any work site
- Robust Design – IP23S designed for fabrication shop or site application
- PFC ensures a stable arc, resistant to power fluctuations even while working on long extension cables up to 300 feet (12 AWG size)
- Optional analogue remote control (Optional hand remote control MMA4)

### Specifications ES 130i PRO

Input Voltage	Stick (SMAW) Welding Output (230V)	TIG (GTAW) Welding Output (230V)	Current Range
120-230 VAC +/- 15%, 1 ph, 50/60 Hz	130 A / 25.2 V @ 25% Duty Cycle 84 A / 23.4 V @ 60% Duty Cycle 65 A / 22.6 V @ 100% Duty Cycle	130 A / 15.2 V @ 25% Duty Cycle 84 A / 13.4 V @ 60% Duty Cycle 65 A / 12.6 V @ 100% Duty Cycle	10-130 on 230VAC 10-130 on 120VAC, depending on process
Maximum Output	Stick (SMAW) Welding Output (120V)	TIG (GTAW) Welding Output (120V)	Operating Temperature
130 Amp	90 A / 23.6 V @ 25% Duty Cycle 58 A / 22.3 V @ 60% Duty Cycle 45 A / 21.8 V @ 100% Duty Cycle	130 A / 15.2 V @ 25% Duty Cycle 84 A / 13.4 V @ 60% Duty Cycle 65 A / 12.6 V @ 100% Duty Cycle	-10° to +40° C (+14° to +104° F)

### Specifications ES 180i PRO

Input Voltage	Stick (SMAW) Welding Output (230V)	TIG (GTAW) Welding Output (230V)	Current Range		
120-230 VAC +/- 15%, 1 ph, 50/60 Hz	180 A / 27.2 V @ 25% Duty Cycle 116 A / 24.6 V @ 60% Duty Cycle 90 A / 23.6 V @ 100% Duty Cycle	180 A / 17.2 V @ 25% Duty Cycle 116 A / 14.6 V @ 60% Duty Cycle 90 A / 13.6 V @ 100% Duty Cycle	10-180 on 230VAC 10-180 on 120VAC, depending on process		
Maximum Output	Stick (SMAW) Welding Output (120V)	TIG (GTAW) Welding Output (120V)	Operating Temperature		
180 Amp	110 A / 24.2 V @ 25% Duty Cycle 70 A / 22.8 V @ 60% Duty Cycle 55 A / 22.2 V @ 100% Duty Cycle	140 A / 15.6 V @ 25% Duty Cycle 90 A / 13.6 V @ 60% Duty Cycle 70 A / 12.8 V @ 100% Duty Cycle	-10° to +40° C (+14° to +104° F)		
Energy Save Mode	Rated kVA	Open Circuit Voltage	Enclosure Class	Dimensions	Weight
50 W	3.9 kVA	78 V DC	IP23S	15.8" x 6" x 10.4" (403 x 153 x 264 mm)	18.2 lbs (8.25 kg)

### Ordering Information

ROGUE ES 130i PRO	0700500091
ROGUE ES 180i PRO	0700500070

Includes: power source with 3 m (10 ft) mains cable and plug (N6-50P), shoulder strap, electrode holder with 3 m (10 ft) cable and return cable 3 m (10 ft) with clamp.

### Options & Accessories

Rogue Plastic Case	0700500085
HW-17R, 60° Head with Rotary Valve, 12.5 ft (3.8 m), 2 pc. cable/hose assembly twist lock	35857
GRF400-580 Flowmeter Regulator	0781-2701
Electrode Holder 200 A and Lead Assembly, 13 ft (4 m), 50 mm	WS200E13
Ground Clamp 200 A and Lead Assembly, 10 ft (3 m), 50 mm	WS200G10
TIG Foot Control, 15 ft (4.5m) cable and 8-pin connector	W4014450
Power Adapter, 230 V to 120 V, 15 A (2 ft, N6-50R to N5-15P)	W4014000

# Renegade™ ES 300i

## Multi-Voltage, Industrial Stick/TIG Machine



STICK MACHINES

- ES 300i has highest power-to-weight ratio in its class weighing in at 33 lbs. (15 kg) and producing 300 A at 40% duty cycle (3 ph)
- Small, lightweight system can virtually go anywhere on the jobsite; its three handle design makes it easy for transportation and maneuvering through manholes and other hard to reach areas
- ES 300i incorporates excellent performance with 6010 (cellulosic) electrodes and additional functionality to tailor Arc Force for a softer or crisper arc through a 6010 mode
- With an excellent TIG operational range from 5 to 300 A, you'll have the confidence to tackle a broad range of material thicknesses
- Intuitive Interface – the machine's digital readout display, along with large buttons with excellent feedback and controls, make it easy to set parameters and read them from a distance
- Cable Management – an integrated latch system helps control cables so they can be secured to the machine, making it easy to pack up and go

Specifications							
Input Voltage	Welding Output TIG		Welding Output Stick		Current Range	Input Current Draw	Rated kVA
230 – 460 VAC 1 ph, 3 ph +/- 10% 50/60 Hz	300 A/20 V @ 40% Duty Cycle, 3 ph 250 A/20 V @ 60% Duty Cycle, 3 ph 200 A/18 V @ 100% Duty Cycle, 1/3 ph		300 A/30 V @ 40% Duty Cycle, 3 ph 250 A/30 V @ 60% Duty Cycle, 3 ph 200 A/28 V @ 100% Duty Cycle, 1/3 ph		5 – 200 A, 1 ph 5 – 300 A, 3 ph	10 A, 400 – 460 V 11 A, 380 V 20 A, 230 V	11.3 kVA
Open Circuit Voltage	Power Factor @ Max Current	Efficiency @ Max Current	Energy Save Mode	Lead Cord Length	Dimensions L x W x H	Weight	
48 V (32 V - VRD)	0.96	85% (TIG) 89% (Stick)	91 W	10 ft. (3 m)	ES 300i: 15.75 x 5.75 x 10 in. (400 x 146 x 255 mm)	ES 300i: 18 lbs. (8 kg)	

Ordering Information	
Renegade ES 300i	0445100881

Standard package includes power supply, shoulder strap, 10 ft. (3 m) input cable, 2 x OKC 50mm connectors (packages do not contain work cables or electrode cables).

## RUFFIAN ES 150G EDW

Compact Engine Driven Welder

STICK MACHINES



- Advanced control over arc parameters, including adjustable Arc Force, to optimize the arc – especially with 6010 electrodes
- Impressive power output of 150A at 60% duty cycle
- Thermal protection for the welder and generator guaranteeing a long, useful life
- Latest inverter technology ensures a stable and smooth stick arc that produces the cleanest welds
- Trusted Kohler gas engine meets a high standard of power and reliability
- Fuel-efficient 5-gallon gas tank and engine hour meter
- Auxiliary generator output voltage is independent from the welding current, allowing simultaneous use of electrical tools without worrying about adjustments to the welder settings
- Four 120 VAC, 20 A GFCI receptacles and one 240 VAC (6-50R) receptacle, all protected by a circuit breaker and covers
- Easy to maneuver through the job site with large industrial-grade wheels that provide high ground clearance; and ergonomic, removable handles that distribute weight evenly
- 3-year warranty by ESAB on welder/generator and 3-year warranty by Kohler on engine

### Specifications (Welding Machine)

Output Setting Range (DC), Stick (SMAW)/MMA	Rated Duty Cycle, Stick (SMAW)/MMA	Open Circuit Voltage (OCV)
20 A/20.8 V – 150 A/26 V	60% @ 150 A/26 V 100% @ 115 A/24.6 V	78 V

### Specifications (Generator)

Phases	Voltages	Frequency	Peak Power	Continuous Power	Max Current (without Welding)
1 ph	120/240 VAC	60 Hz	4.5 kVA/kW	4 kVA/kW	34 A (120V AC); 17 A (240V AC)

### Specifications (Engine)

Brand, Model, and Warranty	Power	Fuel Type	Cooling Type	Cylinders	RPM
Kohler Command PRO CH440, 3-year warranty by manufacturer	14 HP	Gasoline	Air	1	3600

### Specifications (General)

Fuel Tank Capacity	Enclosure Class	Dimensions L x W x H (w/o Wheels and Handles)	Dimensions L x W x H (w/ Wheels and Handles)	Weight (Empty Gas Tank) (w/o Wheels and Handles)	Weight (Empty Gas Tank) (w/ Wheels and Handles)
18.93 L (5.0 US gal)	IP23S	28.70 x 22.52 x 25.98 in. (729 x 572 x 660 mm)	40.83 x 28.74 x 31.61 in. (1037 x 730 x 803 mm)	223.8 lbs (101.5 kg)	248.0 lb (112.5 kg)

### Ordering Information

ESAB Ruffian ES 150G EDW	0707070150
--------------------------	------------

Includes: Ruffian ES 150G Engine Driven Welder, (2) Industrial grade wheels, (2) industrial grade handles.

### Options & Accessories

Electrode Holder 200A and Lead Assembly, 4 m (13 ft)	WS200E13
Ground Clamp 200A and Lead Assembly, 3 m (10 ft)	WS200G10
Lifting Eye	0707071001
Protective Cover, ES 150G EDW	0707071002
Tweco® Style to OKC Adapter Connector	94251240

Note: Spare and wear parts for Kohler Command PRO CH440 engine are offered by Kohler. See separate user manual for details.



## PORTABILITY

Large **industrial-grade** wheels and handles allow for easier transport around the jobsite.



## POWER + PRODUCTIVITY

**150A** max output: power to weld up to 5/32 in. Stick electrodes. 60% duty cycle at 150A for more **welding productivity**.



## TECHNOLOGY

Inverter-based SMAW welder provides smooth and consistent arcs for **high-quality welds**.



## VERSATILITY

**2-in-1** stick welder / 4.5 kW generator with independent control of output current to run external welding, plasma, and power.



# RUFFIAN

**ES150G**

# RUN WILD



Learn More ▶



## ET 141i AC/DC

Portable AC/DC HF TIG/Stick Welding System



TIG MACHINES

- AC and DC output for aluminum and non-ferrous alloys, stainless, mild steel and chrome moly
- AC Frequency preset sets the frequency of the AC square wave and Wave Balance sets the penetration to cleaning ratio when welding on aluminum
- Lift TIG arc starts for easy arc initiation
- Preflow and postflow presets controls the shielding gas before and after the weld
- Hot Start ensures arc starts without sticking when running Stick (SMAW)

### Specifications

Input Voltage	Supply Voltage	Current Range	Max. Output	Rated kVA	Supply Plug	Lead Cord Length
Nominal 120 VAC 1 ph, 50/60 Hz	108-132 VAC	10-140 A	140 A	5 kVA @ 180 A	NEMA 5-20P	10 ft. (3 m)
Welding Output			Open Circuit Voltage	Protection Class		
TIG (GTAW) welding output 40°C (104°F) 140 A/15.6 V @ 20% Duty Cycle 75 A/13 V @ 60% Duty Cycle 60 A/12.4 V @ 100% Duty Cycle		Stick (SMAW) welding output 40°C (104°F) 90 A/23.6 V @ 20% Duty Cycle		77.6 VDC/92.8 VAC	IP23S	
				Dimensions L x W x H	Weight	
				17 x 9.45 x 15.75 in. (432 x 240 x 400 mm)	48.4 lbs. (22 kg)	

### Ordering Information

ET 141i AC/DC TIG/Stick System	W1006311
--------------------------------	----------

W1006311 Includes: ET 141i AC/DC power supply, argon flow gauge regulator and 12.5 ft. (3.8 m) hose, TIG torch and accessories, 17 Style, 13 ft. (4 m), 4 general purpose stick electrodes (E6013), power adapter 120V 20A to 15A, 10 ft. (3 m) power cord and NEMA 5-20P 120 VAC plug, 150A electrode holder with 13 ft. (4 m) lead, 150A ground clamp with 3 m (10 ft.) lead, operator's manual.

### Options & Accessories

TIG Torch and Accessories, 17 Style, 13 ft. (4 m)	W4012701
Electrode Holder 200A and Lead Assembly, 13 ft. (4 m), 50 mm	1201-9577
Ground Clamp 200 A and Lead Assembly, 10 ft. (3 m), 50 mm	1201-9585
Victor Argon Flow Gauge Regulator GF-250-50-580	0781-9411
Gas Hose, 12.5 ft. (3.8 m), Male 5/8-18UNF	W4013900
Foot Control, 15 ft. (4.6 m) cable and 8-pin Male Plug	W4013200
Power adapter, 120V 20A to 15A	W4013300
Basic Utility Cart, max 7 in. (177.8 mm) diameter cylinder	W4014700

# ET 186i AC/DC

## Portable AC/DC HF TIG/Stick Welding System



- AC and DC output for aluminum and non-ferrous alloys, stainless, mild steel and chrome moly
- HF Arc Start: provides non-contact arc starting that eliminates tungsten or material contamination
- Pulse: changes the weld current from high to low at a specified frequency, reduces heat input on thin material (0.5 Hz - 200 Hz)
- AC Frequency: adjustable frequency of the AC square wave when welding on aluminum for optimized set up (15 Hz - 150 Hz)
- Wave Balance: adjustable for optimized penetration or cleaning action when welding on aluminum

TIG MACHINES

Specifications						
Input Voltage	Supply Voltage	Current Range	Max. Output	Rated kVA	Supply Plug	Lead Cord Length
208/230 VAC 1 ph, 50/60 Hz	187 - 253 VAC	10 - 200 A (TIG) 10 - 170 A (Stick)	200 A	9.5 kVA @ 200 A	NEMA 6-50P	10 ft. (3 m)
Welding Output			Open Circuit Voltage	Protection Class		
TIG (GTAW) welding output 40°C (104°F) 200 A/18 V @ 20% Duty Cycle 116 A/14.6 V @ 60% Duty Cycle 90 A/13.6 V @ 100% Duty Cycle		Stick (SMAW) welding output 40°C (104°F) 170 A/26.8 V @ 15% Duty Cycle 100 A/24 V @ 60% Duty Cycle 80 A/23.2 V @ 100% Duty Cycle	70.3 VDC/50 VAC	IP23S		
			Dimensions L x W x H	Weight		
			18.7 x 9.5 x 15.8 in. (475 x 240 x 400 mm)	48.4 lbs. (22 kg)		

Ordering Information	
ET 186i AC/DC TIG/Stick System	W1006301

*Includes: ET 186i AC/DC inverter power supply, electrode holder with 13 ft. (4 m) lead, work clamp with 10 ft. (3 m) lead, 26 TIG torch 12.5 ft. (3.8 m) lead with integrated controls and accessories, input power cable/plug 9 ft. (2.75 m), Victor argon flowgauge regulator, 12.5 ft. (3.8 m) hose, electrode bonus, shoulder strap and operating manual/CD.*

*Foot Control package includes: all components from W1006301 plus foot control with 15 ft. (4.6 m) cable.*

*Foot Control/Utility Card package includes: all components from W1006301 plus foot control with 15 ft. (4.6 m) cable and basic utility cart.*

Options & Accessories	
TIG Torch and Accessories (required for TIG welding)	W4013600
Electrode Holder 200A and Lead Assembly, 13 ft (4 m), 25 mm	9110-1177
Ground Clamp 200 A and Lead Assembly, 10 ft (3 m), 25 mm	9255-1140
Victor Argon Flow Gauge Regulator GF-250-50-580	0781-9411
Gas Hose, 12.5 ft (3.8 m), Male 5/8-18UNF	W4013900
Foot Control, 15 ft (4.6 m) cable and 8-pin Male Plug	W4013200
Basic Utility Cart, max 7 in. (177.8 mm) diameter cylinder	W4014700

## Rogue ET 200iP PRO

Portable TIG/Stick Welding System



TIG MACHINES



- Excellent high frequency TIG start ensures no failures on ignition with superior arc characteristics for smooth and stable performance
- Easy to Use – set the welding current and weld with excellent results
- Robust Design – IP23S designed for both fabrication floor or site applications
- Advanced TIG controls for full cycle control to match every application you need, and pulse feature up to 500 Hz for better heat input control
- PFC ensures a stable arc, resistant to power fluctuations even while working on long extension cables up to 328 ft (100 m)
- Compatible with current adjust foot pedal (sold separately)

Specifications						
Primary Voltage	Current Range	Max. Output	Rated kVA	Energy Save Mode	Operating Temperature	Certification Mark
115/230 VAC ±15% 1 ph, 50/60 Hz	10-200 A	200 A	7 kVA	50 W	-10° to +40° C (+14° to +104° F)	CSA
Welding Output			Open Circuit Voltage	Enclosure Class		
TIG (GTAW) welding output 200 A / 18.0 V @ 25% Duty Cycle 129 A / 15.2 V @ 60% Duty Cycle 100 A / 14.0 V @ 100% Duty Cycle		Stick (SMAW) welding output 200 A / 28.0 V @ 25% Duty Cycle 129 A / 25.2 V @ 60% Duty Cycle 100 A / 24.0 V @ 100% Duty Cycle	78 VDC	IP23S		
			Dimensions L x W x H	Weight		
			15.7" x 6" x 10.4" (403 x 153 x 264 mm)	21.2 lbs (9.6 kg)		

Ordering Information	
Rogue ET 200iP PRO CSA	0700500073

Package includes: power source with 10 ft (3 m) mains cable and plug, shoulder strap, TIG torch SR-B 26 type with flexible neck and potentiometer 13 ft (4 m), a set of wear parts including tungsten electrode, SMAW electrode holder 10 ft (3 m), work lead with clamp 10 ft (3 m), gas regulator, power adapter 115V/230V.

Options & Accessories	
Shoulder Strap	0700500086
MMA 4 Analogue Remote Control incl. 32 ft (10 m) cable and 8-pin connector	0700500084
TIG Torch SR-B 26 with Flexible Neck and Potentiometer 13 ft (4 m)	0700025557
TIG Torch SR-B 26 with Flexible Neck and Potentiometer 26 ft (8 m)	0700025591
Victor Argon Flow Gauge Regulator GF-250-50-580	0781-9411
Electrode Holder 200 A and Lead Assembly, 13 ft (4 m), 50 mm	WS200E13
Ground Clamp 200 A and Lead Assembly, 10 ft (3 m), 50 mm	WS200G10
TIG Foot Control, 15 ft (4.5 m) cable and 8-pin connector	W4014450

**COMING SOON**

# ROGUE

**Go rogue with rule-defying MIG and multi-process performance.**

- **MIG and Multi-Process**  
(Synergic MIG, MIG Brazing, Stick, Lift TIG, Flux-Cored)
- **Range of models from 125 A to 210 A**
- **Dual voltage versatility**  
(120V/230V)
- **Rugged industrial-grade housing with multiple lift points and cable management**



Contact your ESAB representative for details on specifications and availability of this product.

**COMING SOON**

**RENEGADE**  
**VOLT**

**LEAD THE CHARGE  
INTO THE VOLT AGE**

**SHOCKINGLY  
POWERFUL**

**SHOCKINGLY  
STRONG**

**SHOCKINGLY  
PRODUCTIVE**

**SHOCKINGLY  
PRO-GRADE**

Contact your ESAB representative for details on specifications and availability of this product



# Renegade™ ET 300iP

## Multi-Voltage, Industrial Stick/TIG Machines



- ET300iP - Pulse HF TIG. 0.1 - 1000 pulse frequency range, the widest range in its category giving you maximum precision TIG welding capability including better arc control, penetration and increased travel speeds
- Air- and water-cooled packages available with easy, intuitive set-up for ET 300iP
- Small, lightweight system can virtually go anywhere on the jobsite; its three handle design makes it easy for transportation and maneuvering through manholes and other hard to reach areas
- With an excellent TIG operational range from 5 to 300 A, you'll have the confidence to tackle a broad range of material thicknesses
- Intuitive Interface – the machine's digital readout display, along with large buttons with excellent feedback and controls, make it easy to set parameters and read them from a distance
- Cable Management – an integrated latch system helps control cables so they can be secured to the machine, making it easy to pack up and go

TIG MACHINES

Specifications							
Input Voltage	Welding Output TIG		Welding Output Stick		Current Range	Input Current Draw	Rated kVA
230 – 460 VAC 1 ph, 3 ph +/- 10% 50/60 Hz	300 A/20 V @ 40% Duty Cycle, 3 ph 250 A/20 V @ 60% Duty Cycle, 3 ph 200 A/18 V @ 100% Duty Cycle, 1/3 ph		300 A/30 V @ 40% Duty Cycle, 3 ph 250 A/30 V @ 60% Duty Cycle, 3 ph 200 A/28 V @ 100% Duty Cycle, 1/3 ph		5 – 200 A, 1 ph 5 – 300 A, 3 ph	10 A, 400 – 460 V 11 A, 380 V 20 A, 230 V	11.3 kVA
Open Circuit Voltage	Power Factor @ Max Current	Efficiency @ Max Current	Energy Save Mode	Lead Cord Length	Dimensions L x W x H	Weight	
48 V (32 V - VRD)	0.96	85% (TIG) 89% (Stick)	91 W	10 ft. (3 m)	ET 300iP: 18.1 x 7.9 x 12.6 in. (460 x 200 x 320 mm)	ET 300iP: 37.3 lbs. (16.9 kg) without cooler 59.3 lbs. (59.3 kg) with cooler	

Ordering Information	
Renegade ET 300iP Std Pkg	0445100921
EC 1000 Water Cooler	0445045880

Standard package includes power supply, shoulder strap, 10 ft. (3 m) input cable, 2 x OKG 50mm connectors & EC 1000 Water Cooler (packages do not contain work cables or electrode cables).

## ET 301i AC/DC

HF TIG Inverter Power Supply



TIG MACHINES



- High output, full digital control, AC/DC, inverter power supply for precision TIG and Stick welding with expanded input voltage capabilities for maximum flexibility
- High frequency start, Lift Arc TIG start, automatic downslope, pulse, repeat (latch) function, memory function and automatic gas management
- Automatic input voltage selection – operates on 208-230/460V single or three phase
- Lightweight and portable at 35.9 lbs. (16.3 kg)
- Tiptronic - 100 memory functions
- Robust aluminum metal case

### Specifications

Input Voltage	Current Range	Effective Input Current	Max. Input Current
208 – 230/460 VAC +/-15%, 1/3 ph, 50/60 Hz	TIG 1 ph: 5 – 200 A TIG 3 ph: 5 – 300 A	Stick 1 ph: 10 – 150 A Stick 3 ph: 10 – 200 A	1 ph: 37.3 A (208 V), 33.7 A (230 V), 18.1 A (460 V) 3 ph: 23.8 A (208 V), 21.6 A (230 V), 11.6 A (460 V)
Welding Output		Open Circuit Voltage	Protection Class
TIG (GTAW) welding output 40°C (104°F) 200 A/18 V @ 60% Duty Cycle, 1 ph 300 A/22 V @ 30% Duty Cycle, 3 ph 170 A/16.8 V @ 100% Duty Cycle, 1/3 ph		<113 V (VRD active)	IP23S
Stick (SMAW) welding output 40°C (104°F) 150 A/26 V @ 100% Duty Cycle, 1 ph 200 A/28 V @ 60% Duty Cycle, 3 ph 165 A/26.6 V @ 100% Duty Cycle, 3 ph			Weight
		Dimensions L x W x H	35.9 lbs. (16.3 kg)
		19 x 7.25 x 13 in. (483 x 185 x 326 mm)	

### Ordering Information

ET 301i AC/DC power source	W1009400
ET 301i AC/DC HF TIG Water-Cooled	W1009401

HF TIG package includes: inverter power source, 300A WC TIG torch w/Accy's., water recirculator, work and electrode lead, gas hose and flowmeter / regulator, industrial cart, operator's manual & set-up DVD, primary cable and Dinse plugs.





## ET 301i AC/DC Accessories

Options & Accessories	
TIG Torch, 26 w/8 pin hand remotes, 12.5 ft. (3.8 m), 2 in. (50 mm) & accessory kit	W4013600
TIG Torch, 18, 25 ft. (7.6 m), water-cooled, 2 in. (50 mm) & accessory kit	W4013604
Tweco 200A electrode holder & lead assy. 13 ft. (4 m) length, 2 in. (50 mm) Dinse	91101177
Tweco 200A ground clamp & lead assy. 10 ft. (3 m) length, 2 in. (50 mm) Dinse	92551140
Victor ESS3-RG-580 EDGE Argon flowgauge regulator	0781-5120
Gas hose, 12.5 ft. (3.8 m) length, male 5/8 in. -18unf gas fittings	W4013900
Foot control contactor on/off & current control w/8-pin male plug and 15 ft. (4.6 m) cable	600285
Foot control contactor on/off & current control w/8-pin male plug and 25 ft. (7.6 m) cable	10-4016
HP-100 hand held remote control pendant	10-4014
Torch mounted contactor on/off w/8-pin male plug and 15 ft. (4.6 m) cable	10-4006
Torch mounted contactor on/off w/8-pin male plug and 25 ft. (7.6 m) cable	10-4007
Torch mounted contactor on/off & current control w/8-pin male plug & 15 ft. (4.6 m) cable, fits CK9 style handle	10-4008
Torch mounted contactor on/off & current control w/8-pin male plug & 15 ft. (4.6 m) cable, fits CK17 style handle	10-4009
Torch mounted contactor on/off & current control w/8-pin male plug & 15 ft. (4.6 m) cable, fits CK26 style handle	10-4010
Torch mounted contactor on/off & current control w/8-pin male plug & 25 ft. (7.6 m) cable, fits CK9 style handle	10-4011
Torch mounted contactor on/off & current control w/8-pin male plug & 25 ft. (7.6 m) cable, fits CK17 style handle	10-4012
Torch mounted contactor on/off & current control w/8-pin male plug & 25 ft. (7.6 m) cable, fits CK26 style handle	10-4013
Torch mounted contactor on/off & current control w/8-pin plug & 15 ft. (4.6 m) cable	600296
Torch mounted contactor on/off & current control w/8-pin plug & 25 ft. (7.6 m) cable	600297
110VAC water recirculator	W4001303
Water recirculator to power supply interface cable	W4001350
Industrial trolley (running gear/cylinder rack)	W4010003





# ESAB EM 210

ESAB Dual Voltage 200 Amp  
MIG/Flux Cored Welding System



- ESAB EM 210 is a MIG/Flux Cored welding system with a 30 – 200A output; welds material from 22 gauge up to 3/8 in. in a single pass; accepts 4 in. and 8 in. diameter wire spools
- Improve welding results with advanced functions typically found on industrial machines: MIG wire run-in, burn-back, variable inductance, 2T/4T trigger control, gas pre and post-flow, Stick hot start and arc force control
- Featuring professional-grade arc characteristics and full featured digital controls which enable fine-tuning of the arc performance to deliver superior welds
- Portability and flexibility to weld in a variety of locations. Unit weighs just under 29 lbs, (13 kg) connect to 120/230V primary power, and are compatible with 10 kVA generators

MIG MACHINES

Specifications						
Primary Voltage	Supply Voltage Range	Open Circuit Voltage	Current Range	Max. Input Current	MIG (GMAW) Welding Voltage Range	Nominal OCV
115/230 VAC +/-15%, 1 ph, 50/60 Hz	97 – 132 VAC 195 – 265 VAC	<113 V (VRD active)	30 – 200 Amps	27.2 – 40 A	115V: 12V-20V 230V: 12V-24V	68 VDC
MIG (GMAW) Welding Output		Maximum Plate Thickness	Wire Feed Speed		Wire Spool Capacity	
115V: 90A/18.5V @40%, 57A/16.9V @100% 230V: 200A/24V @15%, 77A/17.9V @100%		9.5 mm (3/8 in.) @ 230V	2 – 11 m/min (80 – 450 ipm)		100 & 200 mm (4 & 8 in.), 1–5 kg (2–11 lbs)	
Wire Dimensions		Lead Cord		Protection Class	Certification Mark	
Mild Steel	0.6 – 0.8 mm (.024 – .030 in.)	14 A WG NEMA 5-20P, 10 ft (3 m) rubber		IP21S	CSA (Standards)	
Stainless Steel	0.6 – 0.8 mm (.024 – .030 in.)					
Aluminum	0.8 – 0.9 mm (.030 – .035 in.)	Dimensions L x W x H		Weight	Warranty	
Cored Wire	0.8 – 0.9 mm (.030 – .035 in.)	15 x 8.7 x 19.2 in (381 x 221 x 487 mm)		28.7 lbs (13 kg)	3 year	

Ordering Information	
EM 210 MIG 200A Weld System	0700501200

ESAB EM 210 welding packaging includes: Tweco® Fusion® 180 MIG gun with Velocity® consumables, Victor® Argon/CO<sub>2</sub> regulator, Tweco ground clamp with heavy duty 50 mm Dinse connection, 50A-15A (120/230V) power adapter, sample wire spool of ESAB OK AristoRod 12.50 mild steel wire (2#) and 0.024/0.030 and 0.030/0.035 drive rolls.

Options & Accessories	
Tweco Spool Gun 160 A, 12 ft (3.6 m) (required for Al MIG welding)	1027-1397
Tweco Fusion 180 MIG gun with Velocity consumables, 10 ft (3 m)	1017-1338
ESAB TIG Foot Control, 15 ft (4.6 m) cable and 8-pin connector	W4014450
TIG Torch 17 V and Accessories, 13 ft (4 m) 25/50 mm Dinse	W4013802
TIG Accessory Kit .040" & 1/16" (20-115A)	1442-0065
TIG Accessory Kit 3/32" & 1/8" (100-225A)	1442-0066
Victor Argon Flow Gauge Regulator GF-250-50-580	0781-9411
Gas Hose, 12.5 ft (3.8 m), Male 5/8-18UNF	W4013900
Power Adapter, 230 V to 120 V, 15 A (2 ft, N6-50R to N5-15P)	W4014000
Basic Utility Cart	1444-0900

## Fabricator<sup>®</sup> 141i Multi-Process Welding System



- Delivers 3-in-1 MIG, STICK, and TIG capability from one integrated, portable system
- Features digital meters, 4T trigger control and quick change polarity from the front of the power source
- Overload protection shuts down the power source to protect the internal electrical components from overheating
- Intelligent fan control operates when welding commences to cool components and reduce airborne contaminants pulled through the power source
- Infinite voltage control for precise voltage settings, inductance control for arc stability and spatter control, and adjustable burnback control
- Durable metal feed plate features 2-roll drive system, reversible drive rolls and easy-to-set single scaled wire tension knob
- Adjustable arc force control for optimum Stick (SMAW) electrode performance and built-in hot start for easy arc starting
- Lift TIG arc starts for easy arc initiation
- Spool-gun ready (Spool-gun sold separately)

### Specifications

Input Voltage	Current Range	Wire Feed Speed	Rated kVA	Supply Voltage Range	MIG Voltage Range	Open Circuit Voltage
120 VAC	10 – 140 A	90 – 390 ipm (2.3 – 9.9 m/min)	5 kVA @ 140 A	95 – 140 VAC	14.5 – 19 V	53 V
Welding Output					Wire Diameter	
MIG (GMAW) 140 A/19 V @ 15% Duty Cycle 90 A/18.5 V @ 20% Duty Cycle		TIG (GTAW) 140 A/15.6 V @ 15% Duty Cycle 100 A/14 V @ 20% Duty Cycle		Stick (SMAW) 90 A/23 V @ 15% Duty Cycle 80 A/23.2 V @ 35% Duty Cycle		Mild Steel Stainless Aluminum Flux-Cored
						.023 – .030 in. (0.6 – 0.8 mm) .023 – .030 in. (0.6 – 0.8 mm) .030 in. (0.8 mm) .030 – .035 in. (0.8 – 0.9 mm)
Maximum Output	Max Plate Thickness	Supply Plug	Lead Cord Length	Protection Class	Dimensions L x W x H	Weight
140 A	3/16 in. (4.8 mm)	NEMA 5-20P	10 ft. (3 m)	IP23S	16.2 x 8.3 x 17.7 in. (410 x 210 x 450 mm)	32.2 lbs. (14.6 kg)

### Ordering Information

Fabricator 141i Package	W1003141
Fabricator 141i Package with Cart	W1003142

*Includes power supply, flowgauge regulator and 12.5 ft. (3.8 m) hose, electrode holder with 13 ft. (4 m) lead, bonus contact tips (1 each) .023 in. (0.6 mm), .030 in. (0.8 mm) installed, .035 in. (0.9 mm), drive rolls .023/.030 in. (0.6/0.8 mm) V-groove installed, .030/.035 in. (0.8/0.9 mm) for flux cored wire, Tweco Fusion 140A MIG Gun with 10 ft. (3 m) cable, 4 general purpose stick electrodes (E6013), power adapter 115V, 20A to 15A, ground clamp with 10 ft. (3 m) lead, shoulder strap, operator's manual and CD, 10 ft. (3m) power cord and NEMA 5-20P 115V AC plug.*

### Options & Accessories

TIG Torch and Accessories (required for TIG welding)	W4013802
Tweco Spool Gun 160 A, 12 ft. (3.6 m) (required for Al MIG welding)	1027-1390
Ground Clamp and Lead Assembly, 10 ft. (3 m), 25 mm	W7003105
Electrode Holder and Lead Assembly, 13 ft. (4 m), 25 mm	W7003106
Dinse Adapter, 50 mm Female to 25 mm Male	W4017500
Victor GF250-50-580 Argon Flowgauge Regulator	0781-9411
Foot Control, 15 ft. (4.6 m) cable and 8-pin Male Plug	600285
Gas Hose, 12.5 ft. (3.8 m), Male 5/8-18UNF	W4013900
Power Adapter - 120 V, 20 A to 15 A	W4013300
Basic Utility Cart, max 7 in. (177.8 mm) diameter cylinder	W4014700
Drive Roll, V-Groove, .023/.030 in. (0.6/0.8 mm) (installed)	7977036
Drive Roll, Knurled V-Groove, .030/.035 in. (0.8/0.9 mm) (FCAW)	7977732

# ESAB EMP 210

ESAB Dual Voltage 200 Amp Multi-Process MIG/Stick/DC TIG Welding System



- ESAB EMP 210 is a Multi-Process MIG/Flux Cored/Stick/Lift TIG welding system with a 10 –200A output. Stable Lift TIG arc at low amperage for more control; power to run stick electrodes up to 5/32 in. Digital controls with large easy-to-read LED display enable fast, easy and more accurate operation
- Improve welding results with advanced functions typically found on industrial machines: MIG wire run-in, burn-back, variable inductance, 2T/4T trigger control, Lift TIG arc starts, gas pre and post-flow, Stick hot start and arc force control
- Featuring professional-grade arc characteristics and full featured digital controls which enable fine-tuning of the arc performance to deliver superior welds.
- Portability and flexibility to weld in a variety of locations. Unit weighs just under 29 lbs (13 kg) connects to 120/230V primary power, and is compatible with 10 kVa generators
- System is spool gun-ready for MIG aluminum with optional spool gun and optional remote foot control for Lift TIG welding. (Spool gun and remote foot control sold separately.)

Specifications						
Primary Voltage	Supply Voltage Range	Open Circuit Voltage	Current Range	Max. Input Current	MIG (GMAW) Welding Voltage Range	Nominal OCV
115/230 VAC +/-15%, 1 ph, 50/60 Hz	97 – 132 VAC 195 – 265 VAC	<113 V (VRD active)	10 – 200 Amps	20 – 40 A	115V: 12V-20V 230V: 12V-24V	68 VDC
MIG (GMAW) Welding Output		STICK (SMAW) Welding Output		Lift TIG (GTAW) Welding Output		
115V: 90A/18.5V @40%, 57A/16.9V @100% 230V: 200A/24V @15%, 77A/17.9V @100%		115V: 70A/22.8V @40%, 44A/21.8V @100% 230V:170A/26.8V @20%, 66A/22.6V @100%		115V:90A/13.6V @40%, 57A/12.3V @100% 230V:200A/18V @15%, 77A/13.1V @100%		
Maximum Plate Thickness		Wire Feed Speed		Wire Spool Capacity		
9.5 mm (3/8 in.) @ 230V		2 – 11 m/min (80 – 450 ipm)		100 & 200 mm (4 & 8 in.), 1–5 kg (2–11 lbs)		
Wire Dimensions		Lead Cord		Protection Class	Certification Mark	
Mild Steel	0.6 – 0.8 mm (.024 – .030 in.)	14 A WG NEMA 5-20P, 10 ft (3 m) rubber		IP21S	CSA (Standards)	
Stainless Steel	0.6 – 0.8 mm (.024 – .030 in.)					
Aluminum	0.8 – 0.9 mm (.030 – .035 in.)	Dimensions L x W x H		Weight	Warranty	
Cored Wire	0.8 – 0.9 mm (.030 – .035 in.)	15 x 8.7 x 19.2 in (381 x 221 x 487 mm)		28.7 lbs (13 kg)	3 year	

MULTI-PROCESS MACHINES

Ordering Information	
EMP 210 MP 200A Weld System w/TIG	0700503200

ESAB EMP 210 welding packaging includes: Tweco® Fusion® 180 MIG gun with Velocity® consumables, Victor® Argon/CO<sub>2</sub> regulator, Tweco ground clamp with heavy duty 50 mm Dinse connection, 50A-15A (120/230V) power adapter, sample wire spool of ESAB OK AristoRod 12.50 mild steel wire (2#) and 0.024/0.030 and 0.030/0.035 drive rolls, plus a Tweco 17V TIG torch and Tweco electrode holder.

Options & Accessories	
Tweco Spool Gun 160 A, 12 ft (3.6 m) (required for Al MIG welding)	1027-1397
Tweco Fusion 180 MIG gun with Velocity consumables, 10 ft (3 m)	1017-1338
ESAB TIG Foot Control, 15 ft (4.6 m) cable and 8-pin connector	W4014450
TIG Torch 17 V and Accessories, 13 ft (4 m) 25/50 mm Dinse	W4013802
TIG Accessory Kit .040" & 1/16" (20-115A)	1442-0065
TIG Accessory Kit 3/32" & 1/8" (100-225A)	1442-0066
Victor Argon Flow Gauge Regulator GF-250-50-580	0781-9411
Gas Hose, 12.5 ft (3.8 m), Male 5/8-18UNF	W4013900
Power Adapter, 230 V to 120 V, 15 A (2 ft, N6-50R to N5-15P)	W4014000
Basic Utility Cart	1444-0900

# CHOOSE THE RIGHT REBEL.



**Rebel 205ic AC/DC**

**Rebel 215ic**

<b>Wire Range</b>	Full range of .030 solid wire Solid wire: .023–.045 Flux cored: .030–.045	Full range of .030 solid wire Solid wire: .023–.045 Flux cored: .030–.045
<b>Rated Output (amps @ duty cycle)</b>	<b>MIG</b> 110A @ 100% 150A @ 40% 205A @ 25% <b>STICK</b> 100A @ 100% 125A @ 60% 170A @ 25% <b>AC/DC TIG</b> 110A @ 100% 125A @ 60% 205A @ 25%	110A @ 100% 150A @ 40% 205A @ 25%
<b>Max Output</b>	<b>MIG/STICK</b> 235A <b>AC/DC TIG</b> 205A	235A
<b>Input Rating</b>	110/230V (operating range 90/270V)	110/230V
<b>MAX Plate Thickness</b>	24 ga., 3/8 in.	24 ga., 3/8 in.
<b>Spool Capable</b>	4 in., 8 in.	4 in., 8 in.
<b>Weight</b>	49 lbs	40 lbs
<b>Available Models and Processes</b>	<b>EMP 205ic AC/DC TRUE ALL-PROCESS</b> <i>MIG</i> <i>Flux cored</i> <i>Stick</i> <i>DC TIG</i> <i>AC HF TIG</i>	<b>EMP 215ic TRUE MULTI-PROCESS</b> <i>MIG</i> <i>Flux cored</i> <i>Stick</i> <i>DC TIG</i>



**Rebel 235ic**

**Rebel 285ic**

Full range of .035 solid wire

Full range of .045 solid wire

Solid wire: .023-.045  
Flux cored: .030-.052

Solid wire: .023-.052  
Flux cored: .030-.060

160A @ 100%  
200A @ 60%  
235A @ 40%

**1PH UNIT**  
160A @ 100%  
220A @ 60%  
285A @ 40%

**3PH UNIT**  
200A @ 100%  
265A @ 60%  
285A @ 50%

250A

**1 PH UNIT 3 PH UNIT**  
300A 350A

110/230V

**1 PH UNIT 3 PH UNIT**  
110/230V 460/575V

24 ga., 1/2 in.

24 ga., 1/2 in.

4 in., 8 in., 12 in.

4 in., 8 in., 12 in.

53 lbs

70 lbs

**EMP 235ic TRUE MULTI-PROCESS**

**EMP 285ic 1 PH / 3 PH TRUE MULTI-PROCESS**

*MIG Flux cored*      *Stick DC TIG*

*MIG Flux cored*      *Stick DC TIG*

## Rebel™ EMP 205ic AC/DC & EMP 215ic Portable, True All-Process Welding System



[esab.com/rebel](http://esab.com/rebel)

\*EMP 215ic is DC only  
EMP 205ic is AC/DC

EMP 205ic AC/DC



EMP 215ic



- True All-Process – excellent performance on MIG, Flux-Cored, Stick (including 6010 electrodes), DC TIG and AC TIG (EMP 205ic) industrial applications
- EMP 205ic AC/DC includes standard TIG features such as High Frequency starting, DC Pulse, AC Balance Adjustment, and AC Frequency Adjustment
- sMIG Technology - exclusive sMIG (“smart MIG”) feature continuously learns and adapts to the operator’s welding technique to provide a stable arc and superior, repeatable welds; increases productivity for the experienced welder, and reduces training time for novice welders
- Unique, five-handle roll cage industrial design and unibody steel construction in a lightweight, highly portable unit
- TFT Multilingual Display with 4 programmable memory locations for each process, trim adjustment, inductance control, pre/post flow control and spot weld setting
- Rebel Series models come ready-to-weld out of the box with Professional Grade TWECO accessories and Victor gas regulator

### Ordering Information

Rebel EMP 205ic AC/DC 10 ft. (3 m) System	0558102553
Rebel EMP 215ic Multi-Process MIG/TIG/Stick Package	0558102240

Rebel EMP 205ic AC/DC Package includes power supply, Tweco Fusion 180 Velocity MIG gun, electrode holder, Heliarc HW-17 TIG Torch outfit with accessory kit, foot control, .035 in. (0.9 mm) wire, Atom Arc 7018 electrodes, Victor argon flowmeter regulator, 12.5 ft. (3.8 m) hose, return clamp with leads, drive rolls and contact tips, and operator’s manual.

Rebel EMP 215ic Package includes power supply, Tweco Fusion 180A MIG gun, Victor argon flowgauge regulator and 12.5 ft. (3.8 m) hose, Tweco earth clamp with leads, drive rolls and contact tips, sample .030 in. (0.8 mm) wire, Tweco electrode holder and sample electrodes, 17V Style TIG torch, power adapter and operator’s manual.

### Rebel EMP 205ic AC/DC Specifications

Input Voltage	Input Current Draw	Current Range	Wire Feed Speed	Rated kVA	MIG Voltage Range		
120/230 VAC 1 ph +/- 10%, 50/60 Hz	30 A (27.6 A) @ 25% Duty Cycle	5 – 235 A	80 – 475 ipm (2.0 – 12.0 m/min)	4.98 kVA (> 7 kVA generator)	12 – 26 V		
Welding Output				AC TIG Functionality	DC Pulse		
MIG (GMAW) (230V) 205 A/24.3 V @ 25% Duty Cycle (230V) 150 A/21.5 V @ 40% Duty Cycle (230V) 125 A/20.3 V @ 60% Duty Cycle (230V) 110 A/19.5 V @ 100% Duty Cycle	TIG (GTAW) (230V) 205 A/18.2 V @ 25% Duty Cycle (230V) 125 A/15.0 V @ 60% Duty Cycle (230V) 110 A/14.4 V @ 100% Duty Cycle	Stick (SMAW) (230V) 170 A/27.2 V @ 25% Duty Cycle (230V) 125 A/25.0 V @ 60% Duty Cycle (230V) 100 A/24.0 V @ 100% Duty Cycle	Balance Range	1 – 99%	1 – 500 p/s		
Open Circuit Voltage	Power Factor @ Max Current	Efficiency @ Max Current	Max Plate Thickness	Lead Cord Length	Protection Class	Dimensions L x W x H	Weight
68 V	0.98	83%	3/8 in. (9.5 mm)	6 ft. (1.8 m)	IP23	23 x 9 x 16 in. (584 x 229 x 406 mm)	49 lbs. (22 kg)

### Rebel EMP 215ic Specifications

Input Voltage	Current Range	Supply Voltage Range	Wire Feed Speed	Rated kVA	MIG Voltage Range	Open Circuit Voltage
120 VAC, 208/230 VAC 1 ph, 50/60 Hz	5 – 150 A (120 V) 5 – 240 A (230 V)	90 – 270 VAC	80 – 475 ipm (2.0 – 12.0 m/min)	4.5 kVA (120 V) 7 kVA (230 V)	10 – 26 V	68 V
Welding Output				Wire Diameter		
MIG (GMAW) (120 V) 130 A/20.5 V @ 20% Duty Cycle (230 V) 205 A/24.3 V @ 25% Duty Cycle	TIG (GTAW) (120 V) 130 A/15.2 V @ 40% Duty Cycle (230 V) 180 A/17.2 V @ 30% Duty Cycle	Stick (SMAW) (120 V) 90 A/23.6 V @ 40% Duty Cycle (230 V) 180 A/27.2 V @ 25% Duty Cycle	Mild Steel	.023 – .035 in. (0.6 – 0.9 mm)		
			Stainless	.030 – .035 in. (0.8 – 0.9 mm)		
			Aluminum	.030 – .045 in. (0.8 – 1.2 mm)		
			Flux-Cored	.030 – .045 in. (0.8 – 1.2 mm)		
Maximum Output	Max Plate Thickness	Supply Plug	Protection Class	Dimensions L x W x H		Weight
235 A / 26 V	3/8 in. (9.5 mm)	230 V, NEMA 6-50P	IP23S	23 x 9 x 16 in. (584 x 229 x 406 mm)		40 lbs. (18.2 kg)

MULTI-PROCESS MACHINES



# Rebel™ EMP 235ic & EMP 285ic

## Industrial, Multi-Process Packages



[esab.com/rebel](http://esab.com/rebel)

EMP 235ic



EMP 285ic shown with optional cart



- True Multi-Process – excellent performance on MIG, TIG and STICK
- Unmatched Portability – weighing in at 53 lbs. (24 kg) with dual voltage capability and 4 handle roll cage
- Power to Perform – have the confidence to run the full range of .035 in. (0.9 mm) wire – short arc and spray transfer
- Run solid wire up to .045 in. (1.2 mm) and cored wire up to .052 in. (1.4 mm), plus stick electrodes up to 5/32 in. (4.0 mm) and TIG rods up to 3/16 in. (5.0 mm)
- sMIG Technology – innovative “smart-MIG” feature that dynamically monitors the arc characteristics ultimately adapting to your technique resulting in a smooth, stable arc

### Ordering Information

Rebel EMP 235ic Multi-Process Package	0558012702
Rebel EMP 235ic Multi-Process Package with cart	0558012704
Rebel EMP 285ic 120 V – 230 V, 1 ph System	0558102554
Rebel EMP 285ic 460 V – 575 V, 3 ph System	0558102556
Rebel EMP 285ic 120 V – 230 V, 1 ph System with Cart	0558102555
Rebel EMP 285ic 460 V – 575 V, 3 ph System with Cart	0558102557

Rebel EMP 235ic Package includes power supply, Tweco Spray Master 250 MIG gun, Victor argon flowmeter regulator, 12.5 ft. (3.8 m) hose, return clamp with leads, drive rolls and contact tips, .035 in. (0.9 mm) wire, electrode holder and Atom Arc 7018 electrodes, power adapter, and operator's manual. Cart packages include single cylinder cart.

Rebel EMP 285 Packages includes power supply, Tweco Spray Master Velocity V250 MIG gun, electrode holder, Atom Arc 7018 electrodes, Victor argon flowmeter regulator, 12.5 ft. (3.8 m) hose, return clamp with leads, drive rolls and contact tips, .035 in. (0.9 mm) wire and operator's manual. Cart packages include single cylinder cart.

MULTI-PROCESS MACHINES

Rebel EMP 235ic Specifications							
Input Voltage	Current Range	Wire Feed Speed	Rated kVA	MIG Voltage Range	Open Circuit Voltage		
120 VAC, 208/230 VAC 1 ph, 50/60 Hz	5 – 150 A (120 V) 5 – 250 A (230 V)	60 – 700 ipm (1.5 – 18 m/min)	4.5 kVA (120 V) 7 kVA (230 V)	10 – 30 V	68 VDC		
Welding Output				Wire Diameter			
MIG (GMAW) (120 V) 120 A/19 V @ 40% Duty Cycle (230 V) 235 A/26 V @ 40% Duty Cycle	TIG (GTAW) (120 V) 130 A/15.2 V @ 40% Duty Cycle (230 V) 240 A/19.6 V @ 40% Duty Cycle	Stick (SMAW) (120 V) 90 A/23.6 V @ 40% Duty Cycle (230 V) 210 A/28.4 V @ 25% Duty Cycle		Mild Steel Stainless Aluminum/FCAW	.023 – .035 in. (0.6 – 0.9 mm) .030 – .035 in. (0.8 – 0.9 mm) .030 – .045 in. (0.8 – 1.2 mm)		
Maximum Output	Max Plate Thickness	Supply Plug	Lead Cord Length	Protection Class	Dimensions L x W x H		Weight
250 A/30 V	1/2 in. (12.7 mm)	230 V, NEMA 6-50P	10 ft. (3 m)	IP23S	26.5 x 11.5 x 19.5 in. (673 x 292 x 495 mm)		53 lbs. (24 kg)

Rebel EMP 285ic Specifications							
Input Voltage	Current Range	Wire Feed Speed	Supply Voltage Range	MIG Voltage Range	Open Circuit Voltage		
120 – 240 VAC 1 ph, 50/60 Hz 460 – 575 VAC 3 ph, 50/60 Hz	5 – 300 A (1 ph) 5 – 350 A (3 ph)	60 – 800 ipm (1.5 – 20.3 m/min)	90 – 270 VAC	12 – 34 V	68 VDC		
Welding Output				Wire Diameter			
MIG (GMAW) 285 A/28 V @ 40% Duty Cycle (1 ph) 220 A/25 V @ 60% Duty Cycle (1 ph) 160 A/22 V @ 100% Duty Cycle (1 ph) 285 A/28 V @ 50% Duty Cycle (3 ph) 265 A/27 V @ 60% Duty Cycle (3 ph) 200 A/24 V @ 100% Duty Cycle (3 ph)	TIG (GTAW) 285 A/21 V @ 40% Duty Cycle (1 ph) 240 A/19 V @ 60% Duty Cycle (1 ph) 185 A/17 V @ 100% Duty Cycle (1 ph) 285 A/21 V @ 50% Duty Cycle (3 ph) 265 A/21 V @ 60% Duty Cycle (3 ph) 220 A/19 V @ 100% Duty Cycle (3 ph)	Stick (SMAW) 260 A/30 V @ 40% Duty Cycle (1 ph) 210 A/28 V @ 60% Duty Cycle (1 ph) 135 A/25 V @ 100% Duty Cycle (1 ph) 285 A/31 V @ 50% Duty Cycle (3 ph) 255 A/30 V @ 60% Duty Cycle (3 ph) 180 A/27 V @ 100% Duty Cycle (3 ph)		Mild Steel Stainless Aluminum Flux-Cored	.023 – .052 in. (0.6 – 1.3 mm) .030 – .052 in. (0.8 – 1.3 mm) .030 – 1/16 in. (0.8 - 1.6 mm) .030 – 1/16 in. (0.8 - 1.6 mm)		
Maximum Output	Max Plate Thickness	Supply Plug	Lead Cord Length	Protection Class	Dimensions L x W x H		Weight
300 A/34 V (1 ph) 350 A/34 V (3 ph)	1/2 in. (12.7 mm)	NEMA 6-50P (230 V), no plug for 3 ph unit	10 ft. (3 m)	IP23S	26.5 x 11.5 x 19.5 in. (673 x 292 x 495 mm)		70 lbs. (32 kg)

## Rebel™ Series Accessories

Options & Accessories		EMP 205ic AC/DC EMP 215ic	EMP 235ic	EMP 285ic
W4014603	TIG Torch 26 V & Accessories	■	■	■
W4013802	TIG Torch 17 V & Accessories, 13 ft (4 m) 25/50mm Dinse	■	■	■
0558102493	ESAB TXH 201 5/8 npt 12.5 ft (3.8 m) TIG Torch Outfit		■	■
10271397	Tweco Spool Gun 160 A, 12 ft (3.6 m)	■		
10271398	Tweco 200A 12 ft (3.6 m) Spool Gun		■	■
10271399	Tweco 200A 25 ft (7.6 m) Spool Gun		■	
WS200E13	Electrode Holder 200 A & Lead Assembly, 13 ft (4m), 50mm	■		■
91101131	Tweco T532 Electrode Holder		■	
91101132	Tweco T316 Electrode Holder			■
0781-9411	Victor Argon Flow Regulator GF-250-50-580	■		
0781-2743	Victor HRF 1400 Argon Flowmeter Regulator		■	■
W4013900	Gas Hose, 12.5 ft (3.8 m), Male 5/8-18UNF	■	■	
W4014450	Foot Control, 15 ft (4.6 m) cable & 8-pin Male Plug	■	■	■
W4014000	Power Adapter, 230 V to 120 V, 15 A	■	■	■
0558102325	Rebel Utility Cart, max 7 in. (177.8 mm) diameter cylinder	■		
W4015001	Single Cylinder Cart, max 9 in. (228.6 mm)	■		
0558102491	Rebel Single Cylinder Cart	■	■	■
10231277	Tweco Spray Master VELOCITY2 V250 15 ft (4.6 m)		■	■
10361756	Tweco Spray Master VELOCITY2 V350 15 ft (4.6 m)			■

List of optional accessories, some accessories sold separately.



# HEAVY INDUSTRIAL WELDING AT A HIGHER LEVEL.



**WARRIOR™ AND  
ROBUST FEED PRO**

**ROBUST FEED  
PULSE**

**ARISTO® AND  
ROBUST FEED U6**

## ALL-NEW WARRIOR EDGE CX SYSTEM

Equipped with a Warrior Edge pulse MIG power source, a RobustFeed Edge wire feeder, and Exeor Edge torch.

Take performance and productivity up a notch with a lineup that's built for the most demanding industries. Request a product demo at [esab.com/heavy-industrial-welding-fabrication](https://esab.com/heavy-industrial-welding-fabrication) and try before you buy with a complete customized welding system delivered to your facility.

## Warrior™ 300i CC/CV Multi-Process Inverter Power Source



- Leading MiCOR Inverter Technology enables use of longer primary cables, reduces power consumption by up to 25% and reduces weight and size while delivering exceptional welding performance in all processes
- Adjustable inductance control for arc stability and spatter control plus optimized selection modes for CO<sub>2</sub> and mixed gases for MIG welding
- Adjustable hot start control, adjustable arc force control and optimized selection modes for E6010 vertical-up, vertical-down and E7018 electrodes for optimum Stick welding
- Lift TIG start provides TIG arc starting without the use of high frequency
- Special arc gouging mode for optimum air carbon arc gouging
- Weighs less than 54 lbs. (24.5 kg), ideal for on-site and portable welding applications
- For use with UltraFeed 404HD, MobileFeed 201AVS or 301AVS wire feeders
- Suitable for use with other standard OEM wire feeders

### Specifications

Input Voltage	Current Range	Rated kVA	Supply Voltage Range	Input Current	Open Circuit Voltage
208-230/400/460 VAC 1/3 ph, 50/60 Hz	10 – 300 A (1 ph) 10 – 400 A (3 ph)	14.4 kVA @ 400 A	177-529 VAC	53.2 A (280 V/3 ph) 49.1 A (230 V/3ph) 28.6 A (460 V/3ph)	80 VDC
<b>Welding Output</b>					
MIG (GMAW) @ 104°F (40°C) 300 A/29 V @ 25% Duty Cycle, 1 ph 230 A/25.5 V @ 60% Duty Cycle, 1 ph 180 A/23 V @ 100% Duty Cycle, 1 ph 400 A/34 V @ 25% Duty Cycle, 3 ph 300 A/29 V @ 60% Duty Cycle, 3 ph 220 A/25 V @ 100% Duty Cycle, 3 ph		TIG (GTAW) @ 104°F (40°C) 300 A/22 V @ 25% Duty Cycle, 1 ph 230 A/19.2 V @ 60% Duty Cycle, 1 ph 180 A/17.2 V @ 100% Duty Cycle, 1 ph 400 A/26 V @ 25% Duty Cycle, 3 ph 300 A/22 V @ 60% Duty Cycle, 3 ph 220 A/18.8 V @ 100% Duty Cycle, 3 ph		Stick (SMAW) @ 104°F (40°C) 300 A/32 V @ 22% Duty Cycle, 1 ph 230 A/29.2 V @ 60% Duty Cycle, 1 ph 180 A/27.2 V @ 100% Duty Cycle, 1 ph 300 A/32 V @ 60% Duty Cycle, 3 ph 220 A/28.8 V @ 100% Duty Cycle, 3 ph	
<b>Maximum Output</b>	<b>Protection Class</b>	<b>Dimensions L x W x H</b>		<b>Weight</b>	
400 A	IP23S	17.7 x 8.3 x 16.5 in. (450 x 210 x 420 mm)		54 lbs. (24.5 kg)	

### Ordering Information (not for sale in Canada)

Warrior 300i Power Source	0558102558	Warrior 300i/Ultrafeed 4HD Wire Feeder MIG Package	0558102559
---------------------------	------------	--	------------

Warrior 300i Power Source includes 10 ft. (3 m) input lead, two male Dinse connectors 50 mm and operator's manual.

Warrior 300i MIG Package includes Ultrafeed 4HD wire feeder, interconnection and power cable, 15 ft. (4.6 m) Spray Master 450 MIG gun, ground clamp with 10 ft. (3 m) lead, Victor ESS3-FG-580 argon flowgauge regulator, 12.5 ft. (3.8 m) gas hose, industrial cart and everything included with the power source package (0558102558).

### Options & Accessories

Ultrafeed 4HD Wire Feeder	0558102560	Victor Flowgauge Regulator	0781-5120
Robust Feed Pro** Offshore (incl. gas flow meter+heater) Tweco	0445800885	Gas Hose	W4013900
MobileFeed 201AVS with Meters, Tweco Style	0558102206	Foot Control	W4013200
MobileFeed 201AVS with Meters remote, voltage Tweco Style	0558101911	TIG Torch Switch Control, 25 ft. 7.6 m, 14 Pin - On/Off	10-2001
Robust Feed AVS Tweco	0446700882	TIG Torch Switch Control, 25 ft. 7.6 m, 14 Pin - On/Off, Current Control, CK9	10-2002
Control Cable, 6 ft. (1.8 m)	374878-006	TIG Torch Switch Control, 25 ft. 7.6 m, 14 Pin - On/Off, Current Control, CK17	10-2003
Control Cable, 15 ft. (4.6 m)	374878-015	TIG Torch Switch Control, 25 ft. 7.6 m, 14 Pin - On/Off, Current Control, CK26	10-2004
Control Cable, 25 ft. (7.6 m)	374878-025	Dinse Connector	9425-1431
Control Cable, 50 ft. (15.2 m)	374878-050	Industrial Cart	W4010004
Control Cable, 100 ft. (30.4 m)	374878-100	Power Cable, 6 ft. (1.8 m), 50 mm Male - 50 mm Female	W4015850
TIG Torch Kit	10-4080	K3000 Arc Gouging Torch, 600A, 7 ft. (2.1 m), 80 psi	6106-5006
Tweco Electrode Holder	9110-1177	Dust Filter	W7006715
Tweco 300A Ground Clamp	W4009301		

\*\* When using a Robust Feed M-Connect Box - PN 0446750881

# Warrior™ 400i MV & Warrior 500i

## Powerful, Multi-Process Welder



Warrior 400i MV



Warrior 500i shown with RobustFeed Pro and trolley

- Warrior™ is a reliable multi-process welding machine designed for heavy-duty productivity with up to 500 Amps delivered with superb arc characteristics
- Inverter Technology – outstanding arc performance and energy savings expected from an inverter along with increased energy efficiency and more power from a lighter, smaller, and more portable unit
- High-Duty Cycle – for long runs across a variety of applications
- Durable and rugged – IP23 rating for outdoor and indoor use in rough environments along with handles built into frame for crane lifting
- Easy-to-use – clear and intuitive user interface to get started quickly with glove-friendly knobs for quick and easy adjustments
- Warrior 400i MV provides auto sense from 208-460V 3ph
- Parallel Kit available for Warrior 500i for extreme manual gouging operations with Arcair® AirPro™ X4000 torch – contact ESAB for more information
- RTW packages include everything needed for a mobile welding package
- Basic Packages do not include connection cable set or cylinder cart – buy a package system and choose length of connection cable set you need (sets include control cable, welding cable, gas hose) and any accessories of your choice

Specifications		Warrior 400i MV	Warrior 500i
Input voltage		220/460 V, 3ph, 60Hz +/- 10%	460/575 V, 3ph, 60Hz +/- 10%
Permitted load at:		400/34 V @ 60% duty cycle 300A/30 V @ 100% duty cycle	500A/39 V @ 60% duty cycle 400A/34 V @ 100% duty cycle
Mains voltage primary current at:		220/460 V, 3ph, 44/22 A	460/575 V, 28/24 A
Settings range DC	GMAW FCAW SMAW GTAW	16-400 A/8-34 V 5-400 A/8-36 V	16-500 A/15-40 V 5-500 A/10-30 V
Open circuit voltage		56 V peak (without VRD activated) 28 V peak (with VRD activated)	84 V peak (without VRD activated) 28 V peak (with VRD activated)
Energy Saving mode (6.5min after welding)		50 W	40 W
Power factor at maximum current		0.95	0.87
Efficiency at maximum current		85%	90%
Control voltage		42 V, 50/60 Hz	42 V, 50/60 Hz
Operating temperature		14 – 104°F (-10 – 40°C)	14 – 104°F (-10 – 40°C)
Enclosure class		IP 23	IP 23
Application class		S	S
Dimensions, L x W x H, in. (mm)		28.1 x 12.8 x 18.5 in. (712 x 325 x 470 mm)	28.1 x 12.8 x 18.5 in. (712 x 325 x 470 mm)
Weight, lbs (kg)		115 lbs. (52 kg)	115 lbs. (52 kg)

Recommended Parameters for Manual Air Carbon Arc Gouging			
Electrode	Voltage Min	Voltage Max	Electrode Extension
1/4 in. (6.0 mm)	36 V	49 V	2-3 in. (50-76 mm)
5/16 in. (8.0 mm)	39 V	52 V	
3/8 in. (9.5 mm)	43 V	52 V	
1/2 in. (12.7 mm)	48 V (500i in parallel)	54 V (500i in parallel)	

MULTI-PROCESS MACHINES

## Warrior™ 400i MV & Warrior 500i Accessories

### Warrior 400i MV - Ordering Information

Warrior 400i MV CC/CV, 220-460 V, 3 ph, Power Source Only	0465885880	Warrior 400i MV CC/CV, 220-460 V, 3 ph with Robust Feed Pro and Spray Master 450*	0558102696*
Warrior 400i MV WF 404HD 6.5 ft. (1.7 m), SM V350, RTW	0558102281	Warrior 400i MV WF 404HD, SM V350 Basic Package*	0558102278
Robust Feed Pro Offshore (incl. gas flow meter + heater) Tweco*	0445800885	Warrior 400i MV MobileFeed 201AVS, SM V350 Gun Package	0558102274

\*Basic Package Includes: Power Source; 0445800885 Robust Feed Pro; 10401052 SPRAYMASTER 450 MIG Gun 15 ft 1/16; 0781-3634 ESS32-50CFH-580 EDGE 2.0 Regulator; 0349313450 Trolley -4 wheel, single cylinder







### Warrior 500i - Ordering Information

USA			
Warrior 500i 380/460/575 V, 3 ph, Power Source Only	0465350881	Warrior 500i CC/CV3 ph, 460 V pre-set Package with Spray Master 450	0561000189
Warrior 500i WF 404HD SM V350 15' Basic Package	0558102282	Warrior 500i MobileFeed 201AVS, SM V350 Gun Package	0558102391
Warrior 500i WF 404HD 6.5 ft. (2 m), SM V350 Gun 15', RTW	0558102283		

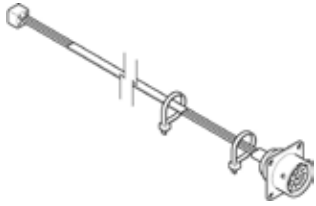
Canada			
Warrior 500i 380/460/575 V, 3 ph, Power Source Only	0465350887	Warrior 500i CC/CV3 ph, 460 V pre-set Package with Spray Master 450	0558102697
Warrior 500i WF 404HD 6.5 ft. (2 m), SM V350 Gun, RTW	0561000156	Warrior 500i WF 404HD SM V350 15' Basic Package*	0561000161

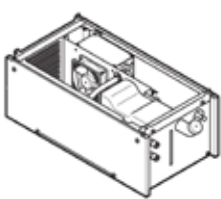
\*Basic Package Includes: Power Source; 0445800885 Robust Feed Pro; 10401052 SPRAYMASTER 450 MIG Gun 15 ft 1/16; 0781-3634 ESS32-50CFH-580 EDGE 2.0 Regulator; 0349313450 Trolley -4 wheel, single cylinder

MULTI-PROCESS MACHINES

 <p><b>Remote Outlet Kit*</b> Part Number: 0465424880</p>	 <p><b>Wheel Kit</b> Part Number: 0465427880</p>	 <p><b>Cooling Unit</b> Part Number: 0465427880</p>	 <p><b>Foot Control FS002</b> Part Number: 0349030886 Requires Remote Outlet Kit</p>
 <p><b>Warrior Trolley</b> Part Number: 0465510880 Use with Warrior Feed 304 only</p>		 <p><b>HD Trolley</b> Part Number: 0558102236 (0558102310 WarriorBracket – order if Trolley purchased separately) (0349303362 Cable Holder Kit – order 2 for HD cart)</p>	

## Warrior™ 400i MV & Warrior 500i Accessories

Options & Accessories	
Robust Feed Pro Offshore (incl. gas flow meter+heater) Tweco	0445800885
Warrior Feed 404HD (Tweco Connection)	0558102235
Warrior YardFeed 200w Water-Cooled	0459906901
MobileFeed 201AVS w/meter (Euro Connection)	0558101910
MobileFeed 201AVS w/meter (Tweco Connection)	0558102194
MobileFeed 301AVS w/meter (Tweco Connection)	0558102195
Robust Feed AVS Tweco	0446700882
Robust Fed AVS Tweco (incl. gas flow meter)	0446700883
Tweco Spray Master V250 MIG Gun (Euro), up to .045 in. (1.2 mm), 15 ft. (4.6 m)	1023-1288
Tweco Spray Master V350 MIG Gun (Tweco), up to 1/16 in. (1.6 mm), 15 ft. (4.6 m)	1036-1756
Tweco Spray Master V450 MIG Gun (Euro), up to 1/16 in. (1.6 mm), 15 ft. (4.6 m)	1040-1850
Victor EDGE ESS3-40-580 Ar Single-Stage Regulator/Flowmeter	0781-5120
MiniBoom Counterbalance Device (Requires Bracket kit 0461310880)	0458705880
Stabilizer kit for Counterbalance Arm	0465509880
Remote Adapter Kit Miggytrac/Railtrac	0465451881
Remote Adapter Kit Miggytrac/Railtrac	0465451881
Remote Cable AN 8-12 Pole 16.4 ft. (5 m)	0459552880
Remote Cable AN 8-12 Pole 32.8 ft. (10 m)	0459552881
Remote Cable AN 8-12 Pole 49.2 ft. (15 m)	0459552882
Remote Cable AN 8-12 Pole 82 ft. (25 m)	0459552883
Remote control AT1	0459491896
Remote control AT1 CoarseFine	0459491897
Remote control M1	0459491895
Remote Outlet Kit for Power Source	0465424880
COOL 2 Water Cooler	0465427880
Female gas hose quick-connector	0365803002
Gas Meter (measures gas flow at the gun)	19043
Guide pin extension kit, feeder	0465508880
Trolley - 4-wheel, 1-cylinder	0465510880
Heavy-Duty Cart, 2-cylinder	0558102236
Swivel Post for Heavy-Duty Cart (Warrior Feed only)	34075
Bracket Kit for Heavy-Duty Cart (0558102236)	0558102310
Wheel kit, power source	0465416880

## Warrior™ 750i ARCAIR Powerful, 850 Amp Multi-Process Welding Machine



- True multi-process package – enables gouging 1/2 in (12.8 mm) electrodes with outstanding performance
- High-Duty Cycle - For long runs across a variety of applications and delivers 820 amps @ 60% duty cycle and 750 amps @ 100%
- Inverter Technology – Warrior brings the outstanding arc performance and energy savings you expect from an inverter, along with increased energy efficiency and more power
- Durable and rugged – Suitable for outdoor and indoor use in rough environments. Warrior 750i paired with Robust Feed PRO, with its robust and weatherproof enclosed design provide the ideal solution whenever portability and durability are key
- Easy-to-use – Clear and intuitive user interface for everyone to get started quickly. Glove-friendly knobs make adjustments quick and easy
- Wide input voltage range to support regional requirements

### Specifications

Primary Voltage	Fuse Slow	Efficiency at Max Current	Power Factor Max Current	Energy Save Mode	Open Circuit Voltage	Mains Cable
380 - 575 V ±10%, 3 ph, 50/60 Hz	70 A	91%	0.91	31 W	94 VDC	4 x 16 Ø mm2
<b>Welding Output</b>						
Arc Gouging (CAC-A) 850 A / 44 V at 35% Duty Cycle 820 A / 44 V at 60% Duty Cycle 750 A / 44 V at 100% Duty Cycle	MIG/MAG (GMAW) 820 A / 44 V at 60% Duty Cycle 750 A / 44 V at 100% Duty Cycle	Stick (SMAW) 820 A / 44 V at 60% Duty Cycle 750 A / 44 V at 100% Duty Cycle	TIG (GTAW) 820 A / 34 V at 60% Duty Cycle 750 A / 34 V at 100% Duty Cycle			
<b>Setting Range</b>					<b>Operating Temperature</b>	
MIG/MAG (GMAW) 8-44 V	Stick (SMAW) 15 – 820 A	TIG (GTAW) 8 – 820 A	-4° to 131° F (-20° to +40° C)			
Enclosure Class	Application Class	Insulation Class	Certification Mark	Dimensions L x W x H	Weight	
IP23	S	H	CSA	33.5 x 16.4 x 25 in. (850 x 415 x 637 mm)	231.5 lbs. (105 kg)	

### Ordering Information

Warrior 750i Arcair, 380-575V, CSA	0445555881	Warrior 750i Arcair, 380-575V, CSA, Robust Feed Pro – BASIC PACKAGE*	0558102739
<b>Interconnection Cables (includes strain relief)</b>			
Interconnection Cables - 70mm², Air-Cooled, 6.5 ft (2.0 m)	0446160880	Interconnection Cables - 70mm², Air-Cooled, 16.5 ft (5.0 m)	0446160881
Interconnection Cables - 70mm², Air-Cooled, 49.2 ft (15.0 m)	0446160883	Interconnection Cables - 70mm², Air-Cooled, 82 ft (25.0 m)	0446160884

\*Basic package includes: Power Source 0445555881, Robust Feed Pro 0445800885, Tweco Spray Master V450 15' 1/16 10401833, Victor EDGE 2.0 ESS32-150-580 0781-3634, Warrior 750i Cart 0446398880

\*\*See Robust Feed Pro on Page 42 for 95 mm Interconnection Cables

### Options & Accessories

Cart 4-wheel Air-cooled	0446398880	Remote Cable AN 8-12 Pole 16.4 ft. (5 m) AT1/AT1 CF	0459552880
OKC Adapter Cable	0446507880	Remote Cable AN 8-12 Pole 32.8 ft. (10 m) AT1/AT1 CF	0459552881
Remote control AT1	0459491896	Remote Cable AN 8-12 Pole 49.2 ft. (15 m) AT1/AT1 CF	0459552882
Remote control AT1 Coarse/Fine	0459491897	Remote Cable AN 8-12 Pole 82 ft. (25 m) AT1/AT1 CF	0459552883
Foot Pedal FS002	0349090886		
<b>Gouging Accessories</b>		<b>Wire Feeders</b>	
Arcair K4000 Air Carbon-Arc Gouging Torch & Cable, Heavy Duty, (1000A, 80PSI /25CFM, 7FT)	61082008	Warrior Feed 404HD (Tweco Connection)	0558102235
Arcair AirPro X4000 Torch & Cable Assembly 7 ft. (2.1 m) - 360° Swivel	61084008	Robust Feed Pro Offshore (incl. gas flow meter+heater) Tweco	0445800885
<b>MIG Guns</b>			
Spray Master 350 Air Cooled MIG Gun (350A, 1/16, 12FT, Tweco)	1036-1613	Spray Master 450 Air Cooled MIG Gun (450A, 1/16, 15FT, Tweco)	1040-1052
Spray Master 350 Air Cooled MIG Gun (350A, 1/16, 15FT, Tweco)	1036-1615	Spray Master 450 Air Cooled MIG Gun (450A, 1/16, 25FT, Tweco)	1040-1058
Classic 5 Air Cooled MIG Gun (500A, 1/16, 15FT, Tweco)	1050-1113		



# Warrior™ 500i

## Multiple Operator Systems - 4 & 6 Packs



- These rack systems feature a rugged design with heavy-duty frame and roof, easily lifted by crane or forklift
- Warrior 500i power sources are reliable, multi-process welding machines designed for heavy-duty productivity with up to 500 Amps delivered with superb arc characteristics
- Choose from 4 or 6-pack racks to get the power you need in one convenient package
- The Multiple Operator Rack Systems are also available for Warrior 300i and Warrior 400i MV machines as well as Aristo Mig 4004i Pulse and Aristo Mig 5000i and Renegade ES 300i machines - contact ESAB for further details
- Easy maintenance with less components
- Hardwired components
- Convenient and reliable circuit breakers, no fuses to replace
- Electrical panel is easy to assemble with high safety standards
- Racks can be ordered alone for existing compatible machines

Specifications		
Dimensions L x W x H	Weight - 4 Pack Rack Warrior 500i	Weight - 6 Pack Rack Warrior 500i
42.2 x 37.5 x 60.5 in. (1071 x 953 x 1537 mm)	1000 lbs. (453.5 kg) with machines 530 lbs. (240.4 kg) without machines	1300 lbs. (589.7 kg) with machines 550 lbs. (249.5 kg) without machines

Ordering Information	
<b>Warrior 500i Multiple Operator System Packages</b>	
Warrior 500i cvcc 460V 4 Pack Rack	0588002034
Warrior 500i cvcc 460V 6 Pack Rack	0588002036
Warrior 500i cvcc 575V 4 Pack Rack	0588002234
Warrior 500i cvcc 575V 6 Pack Rack	0588002236
<b>Rack Only</b>	
4-Pack Rack	0588002232
6-Pack Rack	0588002233

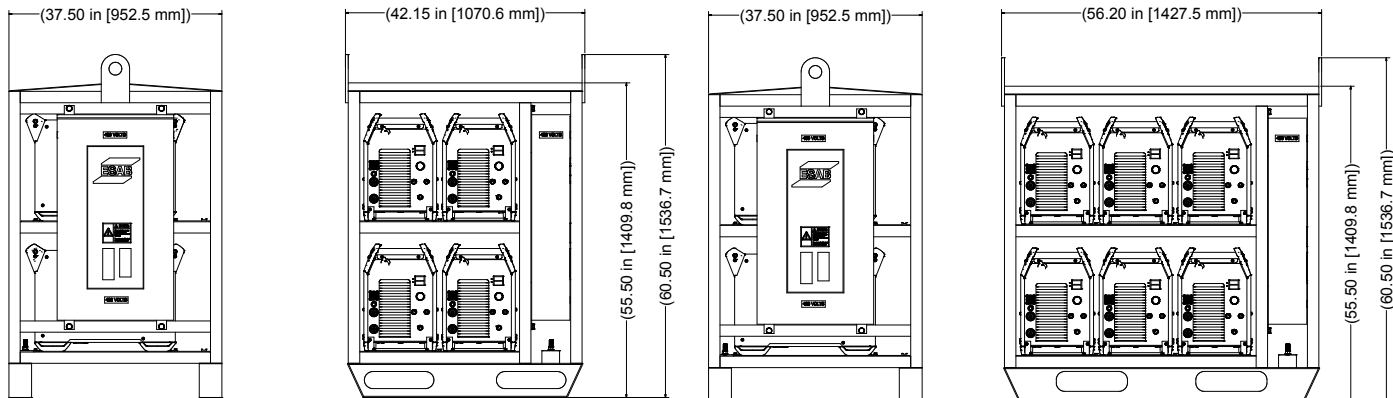

MULTI-PROCESS MACHINES

## Warrior™ EDGE 500 CX Powerful Multi-Process Pulse Power Source



reddot winner 2021



- Fit for purpose weld mode SPEED that provides a focused arc that allows the welder to better and easier handle the weld puddle at higher travel speeds thus increasing the productivity
- Featuring integrated WeldCloud connectivity, the wire feeder RobustFeed Edge offers increased productivity and improved quality management, with wire and gas consumption tracking
- Equipped with TrueFlow, ESAB's digital gas flow control system, RobustFeed Edge effectively manages consumable resources, both in starts and while welding, thus reducing overall shield gas consumption
- SpoolSafe-unique in the market IP54 protection against dirt/dust, keeping your wire dry and clean, protecting the integrity of your weld
- PreciDrive wire drive system maintains precision wire feeding performance to promote consistent weld quality
- A hybrid HMI solution with material selection and configurations on a TFT-screen inside the unit with a clear and easy to use external display for everyday operation makes unit easy to operate

### Specifications

Input Voltage	Current Range	Standby Power	Efficiency/Power Factor @ MAX Current	Open Circuit Voltage
380 – 575 ±VAC 10% 3 ph, 50/60 Hz	16 A (14.8 V) – 500 A (39 V), MIG (GMAW) 5 A (10.2 V) – 500 A (30 V), TIG (GTAW) 16 A (20.6 V) – 500 A (40 V), Stick (SMAW)	43 W	88% / 0.93, MIG (GMAW) 89% / 0.91, Stick (SMAW)	54.8 VDC
Welding Output				Operating Temperature
MIG (GMAW) 500 A/39.0V @ 60% 400 A/34.0V @ 100%	TIG (GTAW) 500 A/30.0V @ 60% 400 A/26.0V @ 100%	Stick (SMAW) 500 A/40.0V @ 60% 400 A/36.0V @ 100%		0 to 131 °F (-20 to +55 °C)
Maximum Output	Protection Class	Dimensions L x W x H	Weight	
500 A	IP23	27.6 x 12.8 x 26.8 in. (700 x 325 x 680 mm)	187 lbs (85 kg)	

### Ordering Information

Warrior Edge 500 CX, 380-575 V, CSA	0446300881
Warrior Edge 500 CX II (incl. SPEED), 380-575 V, CSA	0446300887

### Options & Accessories

Coolant 10 L	0465720002
4-wheel Trolley	0349313450
4-wheel Feeder Trolley for > 12 in. (300 mm) Spools	0349313700
Guide Pin Extension Kit	0465508880
WheelKit, power source	0465416880
RobustFeed Wheel Kit *	0446081880
Boom Adaptor (Lifting Device)	0446956880
Torch Holder Assembly RobustFeed	0446958880
Torch Strain Relief RobustFeed	0446082880
Quick Connector Marathon Pac	F102440880
Analogue Remote, 33 ft (10 m)	0446870880
Analogue Remote, 50 ft (15 m)	0446870881
Analogue Remote, 82 ft (25 m)	0446870882

\* Extension Kit 0465508880 required when Wire Feeder Wheel Kit is used in combination with Trolley 0349313450.

## Warrior™ EDGE 500 CX Torches, Feeders & Cables

Torches			
Description	10 ft (3 m)	12 ft (4 m)	15 ft (5 m)
Exeor MIG 4.0G <sup>2</sup> , Gas-Cooled *	0700025752	0700025753	0700025754
Exeor MIG 4.0G <sup>2</sup> CX, Gas-Cooled, Up/down **	0700025755	0700025756	0700025757
Exeor MIG 4.0W <sup>2</sup> , Water-Cooled *	0700025727	0700025728	0700025729
Exeor MIG 4.0W <sup>2</sup> CX, Water-Cooled, Up/down **	0700025730	0700025731	0700025732

\* Torch with enhanced cooling performance.  
 \*\* Torch with enhanced cooling performance. Includes Torch LED light and CX remote module for JOB selection / WFS / V.  
 For more information on Exeor torches please see separate fact sheets.

Wire Feeders	
RobustFeed Edge BX, Water-cooled, Euro	0446600880
RobustFeed Edge CX, Water-cooled, Digital Gas Control, Heater, Euro	0446600881
RobustFeed Edge DX, Air-cooled, Digital Gas Control, Heater, Rear OKC, Tweco Connect	0446600885

For complete list of wire feeder accessories and interconnection cables please see separate fact sheets or instruction manuals.

Interconnection Cables		
	Gas-Cooled	Water-Cooled
Interconnection Cables - 70mm <sup>2</sup> , 6.5 ft (2.0 m)	0446310880	0446310890
Interconnection Cables - 70mm <sup>2</sup> , 16 ft (5.0 m)	0446310881	0446310891
Interconnection Cables - 70mm <sup>2</sup> , 33 ft (10.0 m)	0446310882	0446310892
Interconnection Cables - 70mm <sup>2</sup> , 50 ft (15.0 m)	0446310883	0446310893
Interconnection Cables - 70mm <sup>2</sup> , 65 ft (20.0 m)	0446310884	0446310894
Interconnection Cables - 70mm <sup>2</sup> , 82 ft (25.0 m)	0446310885	0446310895
Interconnection Cables - 70mm <sup>2</sup> , 115 ft (35.0 m)	0446310886	0446310896
Interconnection Cables - 95mm <sup>2</sup> , 6.5 ft (2.0 m)	0446310980	0446310990
Interconnection Cables - 95mm <sup>2</sup> , 16 ft (5.0 m)	0446310981	0446310991
Interconnection Cables - 95mm <sup>2</sup> , 33 ft (10.0 m)	0446310982	0446310992
Interconnection Cables - 95mm <sup>2</sup> , 50 ft (15.0 m)	0446310983	0446310993
Interconnection Cables - 95mm <sup>2</sup> , 65 ft (20.0 m)	0446310984	0446310994
Interconnection Cables - 95mm <sup>2</sup> , 82 ft (25.0 m)	0446310985	0446310995
Interconnection Cables - 95mm <sup>2</sup> , 115 ft (35.0 m)	0446310986	0446310996

## Aristo® 500ix

Powerful Multi-Process Welding Machines



- Advanced pulse functionality reduces heat input and minimizes spatter
- Up to 250 pre-programmed synergic lines (U82 Plus)
- QSet™ intelligent welding system
- Crater filling, adjustable burn back time and SCT (short circuit termination) options for defect-free weld terminations
- Durable and rugged – IP23 rating for outdoor and indoor use in rough environments
- Compatible with Robust Feed U6 and Pulse, rugged and portable feeder units with excellent feeding performance
- MMA and gouging available from feeder

### Specifications

Mains Voltage	Open Circuit Voltage	Efficiency at Max Current	Power Factor Max Current	Operating Temperature	
380 – 575 V ±10%, 3 ph, 50/60 Hz	58 VDC	88%	0.91	-4° to 131° F (-20° to +40° C)	
Welding Output					
MIG/MAG (GMAW) 500 A / 39.0 V at 60% Duty Cycle 400 A / 34.0 V at 100% Duty Cycle	Stick (SMAW) 500 A / 40.0 V at 60% Duty Cycle 400 A / 36.0 V at 100% Duty Cycle	TIG (GTAW) 500 A / 30.0 V at 60% Duty Cycle 400 A / 26.0 V at 100% Duty Cycle			
Setting Range					
MIG/MAG (GMAW) 16 A / 14.8 V - 500 A / 39 V	Stick (SMAW) 16 A / 20.6 V - 500 A / 40 V	TIG (GTAW) 5 A / 10.2 V - 500 A / 30 V			
Enclosure Class	Application Class	Insulation Class	Certification Mark	Dimensions L x W x H	Weight
IP23	S	H	CSA	28 x 13 x 18.5 in (712 x 325 x 470 mm)	129 lbs (58.5 kg)

### Cool 2 Cooling Unit Specifications

Supply Voltage	Cooling Power	Coolant Volume	Max Flow	Max Pressure	Dimensions L x W x H	Weight
40 VAC	1 kW	1.2 gal (4.5 l)	0.48 gal/min (1.8 l/min)	66.7 PSI (4.6 bar)	27 x 13 x 9 in (680 x 330 x 230 mm)	33 lbs (15 kg) 43 lbs (19.5 kg) w/Coolant

Ordering Information	Power Source Only	Basic Packages*			
Aristo 500ix, 380 – 575V	0446200881	w/ Robust Feed Pulse			0558102737
		w/ Robust Feed U6			0558102716
		w/ Robust Feed U6 water			0558102738
Interconnection Cables (w/strain relief)	Air-Cooled	Water-Cooled	Wire Feeders (w/push-pull, gas flow meter + heater)	Air-Cooled	Water-Cooled
Interconnection – 70 mm 2 CAN, 6 ft (2 m)	0446255880	0446255890	Robust Feed Pulse Air-cooled Tweco 4	0445800893	-
Interconnection – 70 mm 2 CAN, 16 ft (5 m)	0446255881	0446255891	Robust Feed U6 Air-cooled Tweco 4	0445800890	-
Interconnection – 70 mm 2 CAN 50 ft (15 m)	0446255883	0446255893	Robust Feed U6 Water-cooled Euro	-	0445800895
Interconnection – 70 mm 2 CAN, 82 ft (25 m)	0446255885	0446255895	Robust Feed U82 (incl. U82 Plus, ELP, gas flow meter, heater, push-pull) Water-cooled Euro*	-	0445800900

### Options & Accessories

Aristo U82 Plus complete w/ Holder	0460820881	Remote control cable 12 pole - 8 pole 16 ft (5 m)	0459552880	Torch Strain Relief	0446082880
COOL 2 Cooling Unit	0465427880	Remote control cable 12 pole - 8 pole 32 ft (10 m)	0459552881	Trolley (Robust Feed/Warrior Feed)	0349313450
Coolant 3 gal (10 l.)	0007810012	Remote control cable 12 pole - 8 pole 49 ft (15 m)	0459552882	Tweco 4 MIG Gun Connection Kit (included with Robust Feed)	0446120882
Wheel Kit, power source	0465416880	Remote control cable 12 pole - 8 pole 82 ft (25 m)	0459552883		
Remote control MTA1 CAN	0459491880	Remote outlet kit	0465424880	Tweco 5 MIG Gun Connection Kit	0446120884
Remote control unit AT1	0459491896	Stabilizer kit Warrior for Counterbalance Arm	0465509880	Guide Pin Extension Kit **	0465508880
Remote control AT1 Coarse Fine	0459491897	Counterbalance Arm +	0458705880	Liquid Cooling Kit (to upgrade air cooled)	0446123880
Remote control adapter RA 23	0459491911	Robust Feed Wheel Kit	0446081880	Quick Connector Marathon Pac	F102440880

\*Basic Package Includes: Power Source with ground lead and clamp; Robust Feed™; 10401833 Tweco® Spray Master V450 MIG Gun 15 ft 1/16; 0781-3641 – Victor® ESS32-50CFH-580 EDGE 2.0 Flow Gauge Regulator; 0349313450 Cart - 4 wheel, single cylinder; Water cooled Basic Package includes: 0465427880 - Cool 2 unit and Spray Master® MIG Gun is substituted with 10441179 - FUSION PRO 450 W/C 15 ft, Euro.

NOTE: Power Sources, Basic Packages and Ready to Weld Combinations require the customer to supply input power cables. Suggested cable is 4C 8Awg input cable. For Aristo Feed, not Robust Feed. Requires Cart and Stabilizer kit.

\*\* Extension Kit required when Wire Feeder Wheel Kit is used in combination with Cart.  
+ Counterbalance device only works with the Aristo Feed 3004, not with Robust Feed.

# Aristo<sup>®</sup> MIG 4004i Pulse

Light Weight, Multi-Process Inverter Power Source



Aristo Mig 4004i Pulse shown with U8<sub>2</sub> Plus, cooler & Trolley 11

- 400A @ 60%, 300A @ 100% duty cycle for handling
- Aristo<sup>®</sup> Mig 4004i Pulse is designed for high quality, high productivity welding applications
- Features the latest inverter technology to efficiently weld mild steel, stainless steel and aluminum using solid or flux cored wire
- Offers a considerably improved power factor, better than 0.94 and an efficiency of 88% providing minimized energy consumption and significant reductions in your energy cost under similar welding conditions
- Pulse functionality reduces heat input and minimizes spatter
- Available with WeldCloud data management system
- ESAB LogicPump prevents overheating of the torch
- TrueArcVoltage™ system measures the correct arc voltage at the contact tip (together with ESAB torches)

Specifications						
Input Voltage	Current Range DC		Rated kVA	Fuse Slow	Efficiency @ Max Current	Power Factor @ Max Current
380 – 460 V, 3 ph, 50/60 Hz	MIG (GMAW/FCAW) Stick (SMAW) TIG (GTAW)	16 – 400 A 16 – 400 A 4 – 400 A	25.2 kVA	20 A	88%	94%
Welding Output		Open Circuit Voltage	Operating Temperature		Energy Saving Mode	
400 A/34 V @ 60% Duty Cycle 300 A/29 V @ 100% Duty Cycle		55 V or < 35 V VRD	14 to 104 °F (-10 to 40 °C)		40 W	
Protection Class	Dimensions L x W x H		Weight			
IP23S	24 x 10 x 17.5 in. (610 x 250 x 445 mm)		98 lbs. (44.5 kg)		128 lbs. (58 kg) with COOL 1 water cooler	

MULTI-PROCESS MACHINES

Ordering Information (not for sale in Canada)	
Aristo MIG 4004i Pulse, with WeldCloud Top Box*	0445301881

\*For more information on WeldCloud online weld management platform, see WeldCloud fact sheet or visit esab.com.

## Aristo<sup>®</sup> MIG 5000i/U5000i Advanced Synergic Multi-Process Welder



- The multi-process Aristo<sup>®</sup> Mig 5000i power source provides substantially improved arc welding performance and higher productivity for robotic and semi-automatic applications
- Designed to integrate with ESAB's industry-leading WeldCloud<sup>™</sup> online data management platform via Wi-Fi, mobile cellular or hard-wired Ethernet communication
- Proven, robust, heavy-duty industrial system that holds up in the most demanding welding environments
- Modular design allows connection of U6 or U8<sub>2</sub> Plus via mount to feeder or to power source – great for when feeder is boom mounted and hard to reach for normal operation
- U5000i model available for adding process capabilities such as DC TIG and DC Pulse TIG with ESAB TXH torches
- TrueArcVoltage<sup>™</sup> system measures the correct arc voltage at the contact tip (together with ESAB torches)
- Contact ESAB for Robotic Welding Automation to see how the Aristo Mig 5000i model and U8<sub>2</sub> Plus Pendant can be integrated for robotic welding systems

### Specifications

Input Voltage		Current Range DC		Rated kVA	Fuse Slow	Efficiency @ Max Current	Power Factor @ Max Current
3 x 460 V, 3 ph, 50/60 Hz 3 x 208/230/400/460/575 V, 3 ph, 50/60 Hz		MIG (GMAW/FCAW) Stick (SMAW) TIG (GTAW)	16 – 500 A, 8 – 60 V 16 – 500 A 4 – 500 A	25.2 kVA	32 A	87%	91%
Welding Output		Control Voltage	Open Circuit Voltage		Operating Temperature		Energy Saving Mode
500 A/40V at 100 % Duty Cycle 400 A/36 V at 60% Duty Cycle		42 V	MIG (GMAW) Stick (SMAW)	72 – 88 V (59 V VRD) 68 – 80 V (< 35 V VRD)	14 to 104 °F (-10 to 40 °C)		50 W
Mains Cable	Protection Class	Dimensions L x W x H			Weight		
4x8 AWG (4x6 mm <sup>2</sup> )	IP23	24 x 10 x 17.5 in. (610 x 250 x 445 mm) 24.6 x 15.5 x 30.6 in. (625 x 394 x 776 mm) w/cooling unit 24.4 x 15.3 x 10.5 in. (621 x 389 x 266 mm) multi-voltage unit			159 lbs. (72 kg) 203 lbs. (92.1 kg) w/cooling unit 165.4 lbs. (75 kg) multi-voltage unit		

### Ordering Information

Aristo MIG 5000i DC CVCC 460V with WeldCloud	0445400884	Aristo MIG U5000iw DC 460V with WeldCloud	0445400886
--	------------	---	------------

For more information on WeldCloud online weld management platform, see WeldCloud fact sheet or visit [esab.com](http://esab.com).

Power source includes: 16.4 ft. (5 m) mains cable. U5000iw include built-in water cooler.

RTW (Ready To Weld) Stationary Packages: power source, wire feeder, .035/.045 in. (0.9/1.2 mm) V groove feedrolls, V450 15ft. (4.5 m) MIG gun, 5.5 ft. (1.7 m) connection set (gas hose, control cable, welding current cable), 15 ft. (4.5 m) work cable and clamp, regulator/flowmeter.

RTW MIG Racer Packages include: the above plus HD 2-Cylinder Cart.

MULTI-PROCESS MACHINES

## Aristo<sup>®</sup> MIG 4004i Pulse & 5000i/U5000i Accessories

Options & Accessories	
Robust Feed U6 (incl. push-pull, gas flow meter, heater, MMA Outlet) Tweco	0445800890
Robust Feed U6 (incl. push-pull, ELP, gasflow meter, heater, MMA outlet) Water-cooled Euro*	0445800895
Robust Feed U82 (incl. U82 Plus, ELP, gas flow meter, heater, push-pull) Water Cooled Tweco	0445800896
Robust Feed U82 (incl. U82 Plus, ELP, gas flow meter, heater, push-pull) Water-cooled Euro*	0445800900
Aristo YardFeed 200w, U6 Encl. 10 pole, water-cooled	0459906896
Aristo U8 <sub>2</sub> Plus	0460820881
Aristo U8 <sub>2</sub> Plus control cable extension, 24.6 ft. (7.5 m)	0460877891
Strain relief for welding gun	0457341881
Quick connector for Marathon Pac	899F50
Inlet guide for Marathon Pac (use with 899F50)	0558002354
Remote control MTA1 CAN	0459491880
Remote interconnection cable, 16.4 ft. (5 m)	0459960880
Remote adapter kit for Miggytrac/Railtrac	0459681880
COOL 2 Cooling Unit	0465427880
Trolley 4-wheel - standard	0462151880
Trolley 4-wheel - standard, bracket (without COOL 1)	0463125880
Trolley 2-wheel	0460564880
Trolley 4-wheel - for MiniBoom	0460565880
Bracket kit to assemble power source to 2/4-wheel trolley	0461310880
Trolley 4-wheel stabilizer kit for counterbalance device	0460946880
MiniBoom counterbalance device	0458705880
Multi Voltage unit, Wide body (208-575V, 3-ph transformer)	0459145880
Heavy-Duty Dual Cylinder Cart (cannot be used with U5000iw + multi-voltage unit)	0558102236
Guide pin (if no trolley) (Robust Feed Units Only)	0458731880
Remote control MTA1 CAN	0459491880
Remote control AT1 CAN	0459491883
Remote control AT1 CourseFine CAN	0459491884
Work Cable GC-500 15 ft. (4.5 m) 4/0	0558102318
Foot pedal T1 Foot CAN, incl. 16.4 ft. (5 m) cable with 10 pole plug, for connection to the feeder with U6 panel	0460315881
Foot pedal T1 Foot CAN, incl. 16.4 ft. (5 m) cable with 12 pole plug, for connection to the feeder for U8 <sub>2</sub> Plus	0460315880
Trolley 2 for counter balance device and/or 2 gas bottles	0458603880
MMC kit for MMC panel mounted in the power source	0459579880
Water Flow guard complete	0456855880

Aristo® MIG 4004i Pulse & 5000i/U5000i Accessories

Aristo MIG 4004i Pulse Accessories



**COOL 2 Cooling Unit**  
Part Number: 0465427880



**Trolley 11 4-wheel standard**  
Part Number: 0462151880



**Trolley 9 4-wheel**  
Part Number: 0460565880, For use with MiniBoom.

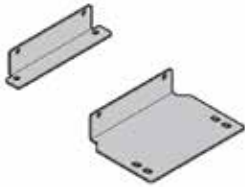

**Trolley 9 Adapter Kit**  
Part Number: 0461310880, For use with MiniBoom.

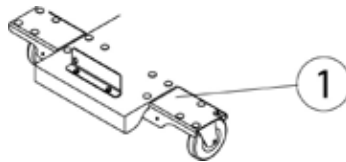

**Stabilizer Kit for Counter Balance Device**  
Part Number: 0460946880, For use with Trolley 9.

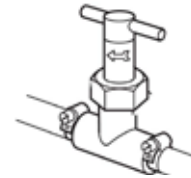

**COOL 1 Flow Guard**  
Part Number: 0456855881



**Bracket for Trolley 11**  
Part Number: 0463125880, Not for use with WeldCloud.

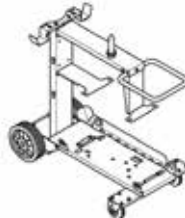

**Trolley 4-wheel**  
Part Number: 0445499880, For use with WeldCloud.

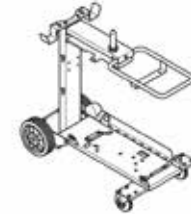

**Trolley 4-wheel**  
Part Number: 0460565880, For use with WeldCloud COOL 1.

Aristo MIG 5000i/U5000i Accessories



**Multi Voltage Unit, Wide Body**  
Part Number: 0459145880

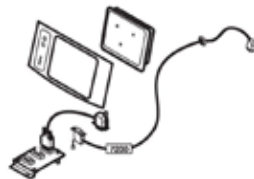

**MMC kit for MMC panel mounted in power source**  
Part Number: 0459579880

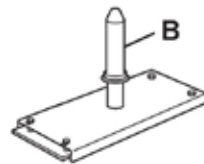

**Guide Pin (if no Trolley used) For use with Feed 3004 only**  
Part Number: 0458731880

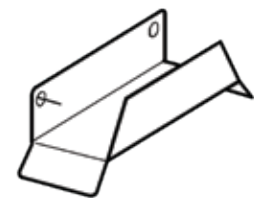

**Cable Holder Kit**  
Part Number: 0349302303

**Insulating Bushing (b), included in guide Pin**  
Part Number: 0278300401



**Trolley 1**  
Part Number: 0458530880

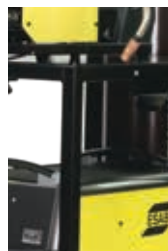

**HD Trolley 2 Cylinders**  
Part Number: 0558102236



**Aristo W82**  
Contact ESAB for more information for information on Robotic welding WeldCloud.



**Trolley 2**  
Part Number: 0458603880  
For MiniBoom and/or 2 gas bottles.

MULTI-PROCESS MACHINES



# MobileFeed 201AVS

Versatile Voltage-Sensing Wire Feeder for use with any CV or CC Welding Power Supply



- Portable, durable wire feeder, available with Tweco connect, built for the toughest welding conditions, with rugged case to stand up to demanding work environments and optimal protection for internal components
- Quick-change, four-roll drive reduces downtime and provides consistent feeding results; rolls are easily changed from one wire size to another without the need for tools
- Digital meters for both Voltage and WFS ensure more arc time, are labor-saving and beneficial for critical welds using specific welding procedures
- Rugged case withstands the harshest environments, keeping downtime for repairs to a minimum
- Robustly designed rubber-mounted internals prevents damage caused by drops and impacts
- Remote control option, available when used with the Warrior™ power supply, allows voltage to be adjusted away from the power supply, reducing setup time and enabling long welds in difficult-to-reach areas

Specifications					
Welding Output	Wire Feed Speed	Wire Diameter	Max Spool Diameter	Dimensions L x W x H	Weight
450A @ 60% duty cycle 400A @ 100% duty cycle	50 – 750 ipm (1.3 – 19.0 m/min)	.045 – 1/16 in. (1.2 – 1.6 mm) Knurled drive rolls as delivered  Range 201AVS: .023 – 1/16 in. (0.6 – 1.6 mm)	201AVS: 8 in. (200 mm)	201AVS: 18.5 x 14.5 x 7.375 in. (470 x 369 x 187 mm)	201AVS: 28 lbs. (13 kg) without spool

Ordering Information	
MobileFeed 201AVS w/Meters-Rem V TWECO	0558101911
MobileFeed 201AVS w/o Meters TWECO	0558102194

WIRE FEEDERS

## Warrior™ Feed 404HD Heavy Duty Industrial Wire Feeder



- Heavy-duty wire feeder engineered for use with the Warrior 500i and Warrior 400i MV CC/CV systems
- Quick-change, heavy-duty drive roll design reduces downtime and provides consistent wire feeding performance for .030 to 3/32 in. (0.8 to 2.5 mm) wire in high-volume and heavy fabrication applications
- Increased productivity through a heavy-duty drive system that delivers high starting torque, rapid response, and reliable feedability in the most demanding applications
- Sun-friendly preset voltage, preset WFS and amperage digital meter displays
- Lower cost of drive roll replacement by 50% as compared to 4-roll driven system
- Upper idler drive system greatly reduces wire distortion and wear in MIG gun parts

Specifications					
Input Voltage	Welding Output	Wire Feed Speed	Operating Temperature	Wire Diameter	
42 VAC, 1 ph, 50/60 Hz	550 A @ 60% Duty Cycle 450 A @ 100% Duty Cycle	60 – 750 ipm (1.5 – 19 m/min)	32 – 104°F (0 – 40°C)	Mild Steel	.035 – 1/16 in. (0.9 – 1.6 mm)
Protection Class	Dimensions L x W x H		Weight	Flux Cored	.035 – 1/8 in. (0.9 – 3.2 mm)
IP23S	10.0 x 18.1 x 29.7 in. (255 x 460 x 755 mm)		48 lbs. (21.5 kg)	Aluminum	.045 – 3/32 in. (1.2 – 2.4 mm)

Ordering Information			
WarriorFeed 404HD (Tweco)	0558102235	Tweco #5 Adapter Kit for Large Wire	W4017601

## Warrior™ YardFeed 200 Highly Portable Wire Feeder



- Pre-settable wire feed speed and small footprint to conveniently fit through manholes and portals with the flexibility to weld in hard-to-reach areas
- Sturdy design features a high-strength steel casing and steel frame to protect controls and connectors
- Easy handling in cramped spaces
- 4-wheel feeder mechanism with encoder feedback for superior wire feeding
- Sun friendly digital V/A and wire feed speed displays
- Variant with water connectors for water-cooled torches available

Specifications					
Input Voltage	Welding Output	Wire Feed Speed	Operating Temperature	Wire Diameter	
42 VAC, 1 ph, 50/60 Hz	365 A @ 60% Duty Cycle	75 – 985 ipm (1.9 – 25 m/min)	14 – 104°F (-10 – 40°C)	Mild Steel	.023 – .045 in. (0.6 – 1.2 mm)
Protection Class	Dimensions L x W x H		Weight	Stainless Steel	.023 – .045 in. (0.6 – 1.2 mm)
IP23S	23.4 x 8.5 x 12.8 in. (595 x 215 x 325 mm)		48 lbs. (21.5 kg)	Flux Cored	.030 – 1/16 in. (0.8 – 1.6 mm)
				Aluminum	.040 – .045 in. (1.0 – 1.2 mm)

Ordering Information	
Warrior YardFeed 200, air-cooled	0459906900
Warrior YardFeed 200, water-cooled	0459906901

WIRE FEEDERS

# Ultrafeed 404HD

## Heavy Duty 4-Roll Wire Feeder



- Use with Warrior™ 300i power supply
- Advanced adjustable features for optimum welding performance; preflow, run in, ramp time, postflow, burnback, crater control, spot and stitch
- Heavy-duty 4-roll drive system for superior wire feeding
- Digital meters for voltage, amperage, wire feed speed; preview and hold capability
- Trigger and spot control: 4T (latch) eliminates operator fatigue, spot welding capability
- Weld schedules allow operator to store two optimized welding parameters then digitally recall them with perfect repeatability
- Inch and purge buttons for advancing wire or purging shielding gas
- Circuit breaker protection - no fuses required
- Indicator lights to identify power and faults; plus control settings over amps and wire feed speed for ipm or mpm

Specifications					
Input Voltage	Welding Output	Wire Feed Speed	Max Spool Diameter	Wire Diameter	
42/115 VAC, 1 ph, 50/60 Hz	550 A @ 60% Duty Cycle 450 A @ 100% Duty Cycle	50 - 660 ipm (1.35 - 16.75 m/min)	8 in. and 12 in. (200 mm and 300 mm)	Mild Steel	.035 – 1/16 in. (0.9 – 1.6 mm)
<b>Dimensions L x W x H</b>		<b>Weight</b>			
10.0 x 18.1 x 29.7 in. (255 x 460 x 755 mm)		48 lbs. (21.5 kg)			
				Flux Cored	.030 – 1/8 in. (0.8 – 3.2 mm)
				Stainless Steel	.035 – 1/16 in. (0.9 – 1.6 mm)
				Aluminum	.035 – 3/32 in. (1.0 – 2.4 mm)
Ordering Information (not for sale in Canada)					
Ultrafeed 404HD			W3400003		

## Robust Feed AVS

Versatile Voltage-Sensing Wire Feeder for use with any CV or CC Welding Power Supply



reddot winner 2021

- Quick-change, four-roll drive reduces downtime and provides consistent feeding results. Rolls are easily changed from one wire size to another without the need for tools
- Digital meters for Voltage and WFS ensure more arc time, are labor-saving and beneficial for critical welds using specific welding procedures
- Durable, drop-proof housing that withstands demanding applications
- Weatherproof, enclosed design that withstands rain from all directions ensures the filler metal is kept dry
- Full use of the Robust Feed family accessories such as wheel kit and strain reliefs make this feeder

### Specifications

Input Voltage, Max.	Wire Feed Speed	Max Spool Diameter	Wire Dimensions		Welding Output
14 - 100 VDC	1.3 – 25.0 m/min (51 – 984 ipm)	12 in. (300 mm)	Mild Steel	.023 – 5/64 in. (0.6 – 2.0 mm)	500 A @ 40% 450 A @ 60% 350 A @100%
<b>Dimensions L x W x H</b> incl. top handle		<b>Weight</b>	Stainless Steel	.023 – 1/16 in. (0.6 – 1.6 mm)	
23.4 x 9.8 x 16.9 in. (595 x 250 x 430 mm)			40.5 lbs. (18.37 kg)	Cored Wire	
<b>Operating Temperature</b>		<b>Wire Spool Capacity</b>	<b>Certification Mark (Standards)</b>		<b>Protection Class</b>
-20° to +55°C (-4 to 131 °F)		44 lbs. (19.9 kg)	CE, CSA, RCM, CCC, EAC, IEC		IP44

### Ordering Information

Robust Feed AVS Tweco	0446700882	Robust Feed AVS Tweco (incl. gas flow meter)	0446700883
-----------------------	------------	--	------------

### Options & Accessories

Robust Feed Wheel Kit	0446081880	Quick Connector Marathon Pac™	F102440880
Torch Strain Relief	0446082880	OKC 50 female cable connector, 1/0-4/0 cable (50 mm²) EU	0160361881
Trolley (Robust Feed/Warrior Feed)	0349313450	OKC 50 male cable connector, 1/0-4/0 cable (50 mm²) EU	0160360881
Trolley Retrofit Kit Robust Feed †	0349313100	2-MPC Tweco female cable connector, 1/0-3/0	94251220
Guide Pin Extension Kit **	0465508880	2-MPC Tweco male cable connector, 1/0-3/0	94251210
Liquid Cooling Kit (to upgrade air cooled feeders)	0446123880		
<b>Air-Cooled Torches</b>			
Spray Master 350 Air Cooled MIG Gun (350A, 1/16, 12 ft, Tweco)	1036-1613	Flux Cored SEFC 350Amps 15ft Self Shielded	30938SP
Spray Master 350 Air Cooled MIG Gun (350A, 1/16, 15 ft, Tweco)	1036-1615	Flux Cored SEFC 450Amps 15ft Self Shielded	44070SP
Spray Master 450 Air Cooled MIG Gun (450A, 1/16, 15 ft, Tweco)	1040-1052	Classic 5 Air Cooled MIG Gun (500A, 1/16, 15 ft, Tweco)	1050-1113
Spray Master 450 Air Cooled MIG Gun (450A, 1/16, 25 ft, Tweco)	1040-1058		

† To fit Robust Feed on previous Warrior Trolley 0465510880

\*\* Extension Kit required when Wheel Kit is used in combination with Trolley.



Wheel Kit works with feeder horizontal or vertical



Internal LED lights and integrated storage for wear parts in lid

WIRE FEEDERS

# Robust Feed PRO

## Ultimate Robustness and Portability



**reddot winner 2021**

- Durable, drop-proof housing that withstands demanding applications
- Great portability with ergonomic handles, 5 lifting points and safe for crane lifting handles
- Weatherproof, enclosed design that withstands rain from all directions and inside heater ensures the filler metal is kept dry
- Large sun-friendly display and clear controls make set up efficient and easy when wearing gloves
- Protected cable connectors and sturdy strain relief for interconnection cable reduces maintenance
- Works as great in the field as in workshops, on a trolley, with or without

Specifications					
Input Voltage	Wire Feed Speed	Max Spool Diameter	Wire Dimensions		Welding Output
42 VAC	0.8 – 25.0 m/min (30 – 985 ipm)	12 in. (300 mm)	Mild Steel	.023 – 5/64 in. (0.6 – 2.0 mm)	550 A @ 50% 500 A @ 60% 400 A @ 100%
<b>Dimensions L x W x H</b> incl. top handle		<b>Weight</b>	Stainless Steel	.023 – 1/16 in. (0.6 – 1.6 mm)	
23.4 in. x 9.8 in. x 16.9 in. (595 x 250 x 430 mm)			37 lbs. (16.8 kg)	Cored Wire	
<b>Wire Spool Capacity</b>		<b>Certification Mark (Standards)</b>		<b>Protection Class</b>	
45 lbs. (20.4 kg)		CE, CSA		IP44	

Ordering Information	
Robust Feed Pro Offshore (incl. gas flow meter+heater) Tweco	0445800885

Options & Accessories			
Robust Feed Wheel Kit	0446081880	Tweco 5 MIG Gun Connection Kit	0446120884
Torch Strain Relief	0446082880	Guide Pin Extension Kit **	0465508880
Trolley (Robust Feed/Warrior Feed)	0349313450	Liquid Cooling Kit (to upgrade air cooled feeders)	0446123880
Trolley Retrofit Kit Robust Feed *	0349313100	Quick Connector Marathon Pac™	F102440880
Euro MIG Gun Connection Kit	0446120880	Robust Feed Pro M Connect †	0446750881
Air-Cooled Torches			
Spray Master 350 Air Cooled MIG Gun (350A, 1/16, 12 ft, Tweco)	1036-1613	Spray Master 450 Air Cooled MIG Gun (450A, 1/16, 25 ft, Tweco)	1040-1058
Spray Master 350 Air Cooled MIG Gun (350A, 1/16, 15 ft, Tweco)	1036-1615	Classic 5 Air Cooled MIG Gun (500A, 1/16, 15 ft, Tweco)	1050-1113
Spray Master 450 Air Cooled MIG Gun (450A, 1/16, 15 ft, Tweco)	1040-1052		
Interconnection Cables			
Interconnection Strain Relief Kit **	0446050880	Interconnection Cables – 70 mm², Air-Cooled, 20.0 m (65.6 ft), +ISF	0446160887
Interconnection Cables – 70 mm², Air-Cooled, 2.0 m (6.5 ft) **	0459836880	Interconnection Cables – 70 mm², Air-Cooled, 25.0 m (82 ft), +ISF	0446160884
Interconnection Cables – 70 mm², Air-Cooled, 5 m (16.5 ft) **	0459836881	Interconnection Cables – 70 mm², Air-Cooled, 35.0 m (115 ft), +ISF	0446160885
Interconnection Cables – 70 mm², Air-Cooled, 10.0 m (32.8 ft) **	0459836882	Interconnection Cables – 95 mm², Air-Cooled, 2.0 m (6.5 ft), +ISF	0446160980
Interconnection Cables – 70 mm², Air-Cooled, 15.0 m (49.2 ft) **	0459836883	Interconnection Cables – 95 mm², Air-Cooled, 5.0 m (16.5 ft), +ISF	0446160981
Interconnection Cables – 70 mm², Air-Cooled, 25.0 m (82 ft) **	0459836884	Interconnection Cables – 95 mm², Air-Cooled, 10.0 m (32.8 ft), +ISF	0446160982
Interconnection Cables – 70 mm², Air-Cooled, 2.0 m (6.5 ft), +ISF	0446160880	Interconnection Cables – 95 mm², Air-Cooled, 15.0 m (49.2 ft), +ISF	0446160983
Interconnection Cables – 70 mm², Air-Cooled, 5.0 m (16.5 ft), +ISF	0446160881	Interconnection Cables – 95 mm², Air-Cooled, 25.0 m (82 ft), +ISF	0446160984
Interconnection Cables – 70 mm², Air-Cooled, 10.0 m (32.8 ft), +ISF	0446160882	Interconnection Cables – 95 mm², Air-Cooled, 35.0 m (115 ft), +ISF	0446160985
Interconnection Cables – 70 mm², Air-Cooled, 15.0 m (49.2 ft), +ISF	0446160883		

\* To fit Robust Feed on previous Warrior Trolley 0465510880

† To connect the Robust Feed Pro to Miller™ power sources.

\*\* To upgrade existing Warrior interconnection cable sets to fit with Robust Feed For full compatibility list please contact your local ESAB representative.

\*\* Extension Kit required when Wheel Kit is used in combination with Trolley.

+ISF (includes strain relief)

## Robust Feed Pulse/U6/U82

### Ultimate Robustness and Portability



Robust Feed Pulse      Robust Feed U6      Robust Feed U82



- Fully portable feeder offering the benefits of pulse – reducing weld spatter and post weld clean up, controlling bead appearance and profile, increased speed for position welding and more depending on the application
- Durable, drop-proof housing that withstands demanding applications
- Great portability with ergonomic handles, 5 lifting points and safe for crane lifting handles
- Weatherproof, enclosed design that withstands rain from all directions and inside heater ensures the filler metal is kept dry IP44 Rating
- Protected cable connectors and sturdy strain relief for interconnection cable reduces maintenance band setup time
- Works great in the field as well as in workshops, on a cart, with or without wheel

#### Specifications

Input Voltage, Max.	Wire Feed Speed	Max Spool Diameter	Wire Dimensions		Welding Output
42 VAC	0.8 – 25.0 m/min (30 – 985 ipm)	12 in. (300 mm)	Mild Steel	.023 – 5/64 in. (0.6 – 2.0 mm)	630 A @ 35% 500 A @ 60% 400 A @100%
<b>Dimensions L x W x H</b> incl. top handle		<b>Weight</b>	Stainless Steel	.023 – 1/16 in. (0.6 – 1.6 mm)	
23.4 x 9.8 x 16.9 in. (595 x 250 x 430 mm)			36.8 lbs. (16.7 kg)	Cored Wire	
<b>Operating Temperature</b>		<b>Wire Spool Capacity</b>	<b>Certification Mark (Standards)</b>		
-20° to +40 °C/ -4 to 104 °F (+55 °C/131 °F with derating)		45 lbs. (20.4 kg)	CE, CSA		IP44

#### Ordering Information

Robust Feed U82 (incl. U82 Plus, ELP, gas flow meter+heater+MMA outlet) Water-cooled Tweco 4	0445800904
Robust Feed U82 (incl. U82 Plus, ELP, gas flow meter+heater+MMA outlet) Water-cooled, Euro	0445800896
Robust Feed Pulse (push pull capable, gas flow meter+heater+MMA outlet) Air-cooled, Tweco 4	0445800893
Robust Feed U6 (push pull capable, gas flow meter+heater+MMA outlet) Air-cooled, Tweco 4	0445800890
Robust Feed U6 (push pull capable, gas flow meter+heater+MMA outlet) Water-cooled, Euro	0445800895

ELP feature needed for use with legacy equipment for example Cool 1.

#### Options & Accessories

Robust Feed Wheel Kit	0446081880	Interconnection Cables	Air-Cooled	Water-Cooled
Torch Strain Relief	0446082880	Interconnection – 70 mm 2 CAN w strain relief, 6 ft (2 m)	0446255880	0446255890
Trolley (Robust Feed/Warrior Feed)	0349313450	Interconnection – 70 mm 2 CAN w strain relief, 16 ft (5 m)	0446255881	0446255891
Guide Pin Extension Kit ** 0465508880	0349313100	Interconnection – 70 mm 2 CAN w strain relief, 50 ft (15 m)	0446255883	0446255893
Liquid Cooling Kit (to upgrade air cooled feeders)	0446123880	Interconnection – 70 mm 2 CAN w strain relief, 82 ft (25 m)	0446255885	0446255895
Quick Connector Marathon Pac™	F102440880	Interconnection Strain Relief Kit Aristo ***		0446050881

\*\* Extension Kit required when Wire Feeder Wheel Kit is used in combination with Trolley.

\*\*\* To upgrade existing Aristo interconnection cable sets to fit with Robust Feed

# Wire Feeder Control Panels

Easy 2 Step Ready To Weld Package Selection

Step 1: Select Basic Package

Step 2: Select Interconnection Length

Panel Functions	Robust Feed Pulse + Aristo 500ix	Robust Feed U6 + Aristo 500ix	Robust Feed U82 + Aristo 500ix
MIG CV	■	■	■
MIG Pulse		■	■
Synergic Lines	Steel, Stainless Steel, Aluminum - 93 lines	Steel, Stainless Steel, Aluminum - 92 lines	Steel, Stainless Steel, Aluminum - 259 manual & 68 robotic lines
Stick	Stick controls and outlet on wire feeder *	Stick controls and outlet on wire feeder *	■
ACAG	■	Gouging controls and outlet on wire feeder *	■
Live TIG	-	■	■
Gas Flow Meter, Heat Kit	■*	■*	■*
2T/4T	■	■	■
Hot Start	■	■	■
Creep Start	■	■	■
Crater Fill	■	■	■
Burnback	■	■	■
SCT	■	■	■
Amperage Setting	■	■	■
Gas Pre- and Post-flow Setting	■	■	■
Qset	■	■	■
Memory Settings	3	10	255
Spot Welding Time	-	■	■
Setting Limits	-	■	■ (and measure limits)
Code Lock	-	■	■ (and user levels)
SuperPulse	-	-	■
Synergic Line Creation	-	-	■

\* Depending on variant

WIRE FEEDERS



Wheel Kit works with feeder horizontal or vertical



Internal LED lights and integrated storage for wear parts in lid

## Aristo® U8<sub>2</sub> Plus Controller

Developed for Durability and Usability



**QSet™** is the best single parameter automatic arc system on the market for the perfect short arc. The advantages are enormous! You set up the machine with the appropriate gas/wire combination, press the torch switch and start welding within seconds.

The machine determines the optimum parameters and makes any changes as required in a fraction of a second. The wire stick out which is normally a constant length in MIG/MAG welding, can be varied with QSet™.

Whether you are close to the work piece with the torch or so far away that the gas protection almost ceases, the welding arc remains unchanged - always perfect. Unbeatable in deep seams, if you have to weld around corners or are welding upwards coming out of the downhand position.

Utilized with CO<sub>2</sub> gas you can weld with QSet with extremely low levels of spatter and can drastically reduce the gas costs, compared with mixed gas, without any loss of quality.

QSet is ideal for welding in restricted positions, root welding, GMA brazing and for reproducible results in the series production of parts. QSet is also available in many other ESAB controller / machine combinations.

### Synergic Lines

In the Aristo U8<sub>2</sub> Plus you have more than 230 synergic lines available to you for your welding applications. From construction steel to Super Duplex, from aluminium to Ni basic alloys or for applications of hard metal. You can create customized synergic lines yourself for any desired material and any combination of protective gas and save them as new synergic lines. You can transfer data via the USB connection, to another Aristo U8<sub>2</sub> or to your computer for data backup or exchange by e-mail.

- ESAB introduced the second generation of Aristo U8<sub>2</sub> digital controllers offering improved welding capacity and operator convenience
- The new U8<sub>2</sub> Plus has been developed as an addition to our Origo® and Aristo® power sources and wire feeder devices as users demanded more functionality and functions
- Designed for advanced manual and mechanized MIG/MAG welding, Pulsed MIG/MAG, TIG, Pulse TIG, STICK welding, as well as carbon arc gouging
- User-friendly design and interface
- Complex controllers are often impossible to understand without an in-depth knowledge of the product - not so with the U8<sub>2</sub> Plus
- The few controls that it has to guide the welder intuitively are ergonomically very easy to use even when wearing protective gloves
- The large, bright display is clear and easy to read, with full text in English and 16 other languages
- It does not have a multitude of tiny knobs or buttons, nor does it use incomprehensible abbreviations

### SAT – Swift Arc Transfer™ (Robotic Welding Only)

Swift Arc Transfer (SAT) is a high productivity GMAW process using AristoRod™ non-copper coated wires with Advanced Surface Characteristics at travel speeds well beyond the limits of normal spray arc welding.

The advantage AristoRod non-copper-coated wire over copper-coated wires is that it does not contaminate the feed system with copper particles. Synergic lines are available for three AristoRod wire sizes and various shielding gases.

SAT produces flat welds with good penetration and without undercut. An additional advantage is the low heat input, resulting in less deformation. SAT is developed for robotic, automated and mechanized welding, and suited for fillet and overlap welds in thin to thick plate, in downhand positions.

SAT uses ESAB inverter power sources together with the Robofeed 3004 wire feeder for wire feed speeds up to 1200 ipm (30 m/min) in conjunction with U8<sub>2</sub> Plus control unit. ESAB provides a complete package of equipment, consumables, and synergic lines as well as the expertise to successfully implement the SAT process.

### Quality Control

For storage of the measured values you are offered two options in the form of the setting limits and measuring limits. The setting limits prevent the operator from inputting excessively high values for the welding process. The measuring limits ensure that the power source does not exceed the input values. Up to 16 User Accounts on three levels with various access rights and blocking codes can be used to prevent unauthorized persons from making changes.

### Production Statistics

The total arc time, total quantity of material and the number of welding processes can be logged per production statistics item. In addition, the arc time and amount of material for the last welding process are recorded, the total weld metal deposited can be recorded – and collected by WeldCloud™.





# Aristo® SuperPulse™

Innovative Process for Heat Input Control

An additional feature of the Aristo U8<sub>2</sub> Plus control is Aristo SuperPulse – a further development of the Pulse/Pulse concept, giving full control over the heat input and thereby expanding the scope of application of the GMAW process resulting in better gap bridging, reduction in distortion, and better balance of the weld penetration and its profile.

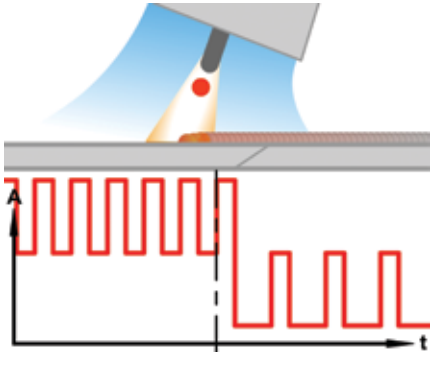
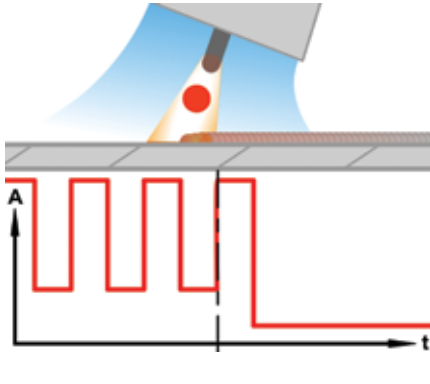
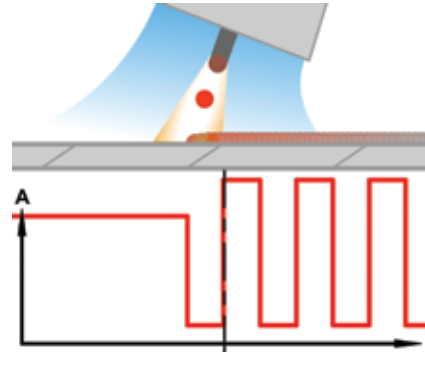
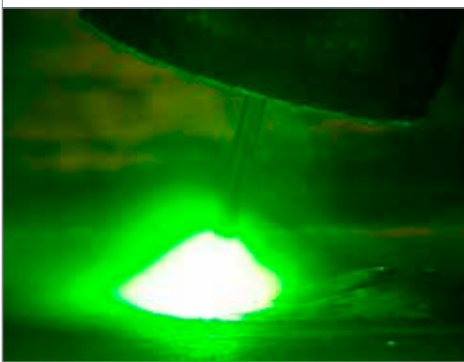
SuperPulse combines the relevant advantages of the various types of arc. For example, the quality of the pulsed arc with the productivity of the spray arc. Or pulse arc with short arc, to introduce the least amount of heat into the thinnest sheets of metal. Or the combination of two pulsed arcs with different frequencies, for example, for the MIG welding of aluminium with a TIG look. It also allows the working range of larger wires to be expanded increasing productivity.

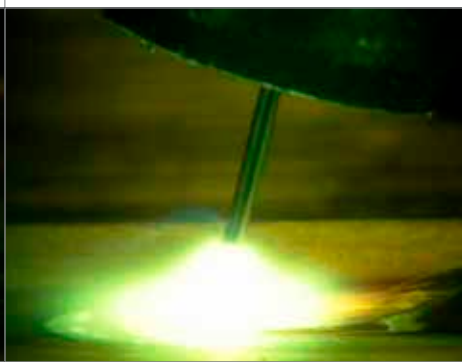
		
		
<p style="text-align: center;"><b>Pulse/Pulse</b></p>	<p style="text-align: center;"><b>Pulse/Short Arc</b></p>	<p style="text-align: center;"><b>Spray/Pulse</b></p>
<ul style="list-style-type: none"> <li>■ All position weldability</li> <li>■ Thicknesses from 0.1 to 0.5 in. (3 to 12 mm)</li> <li>■ Exceptional results on aluminum and stainless steel</li> <li>■ Ascetically pleasing welds with uniform bead</li> </ul>	<ul style="list-style-type: none"> <li>■ Excellent performance on thin stainless and aluminum 0.4 to 0.2 in. (1 to 5 mm)</li> <li>■ Higher travel speeds compared to TIG</li> </ul>	<ul style="list-style-type: none"> <li>■ Better overall results on thicker weldments [0.2 in. (6 mm) and over]</li> <li>■ Better control of fusion and penetration</li> <li>■ Ability to weld thick aluminum vertical up with no weaving</li> </ul>







WIRE FEEDERS

## Aristo SuperPulse Benefits:

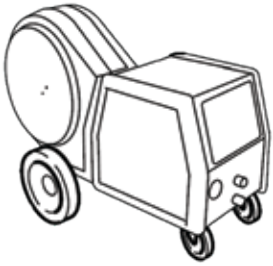
- Easier positional welding
- Uniform penetration
- Less sensitive for root gap variations and unequal heat transfer
- GTAW weld appearance with the GMAW process
- Suitable for automated welding, e.g./with ESAB Railtrac and Miggytrac automated welding tractors
- Extends the working range for larger wire sizes
- With its precisely adjustable heat input and depth of penetration, Aristo SuperPulse can solve difficult welding tasks and increase productivity

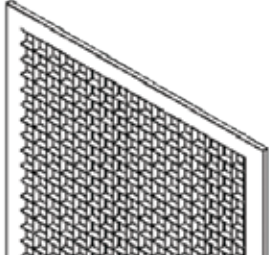
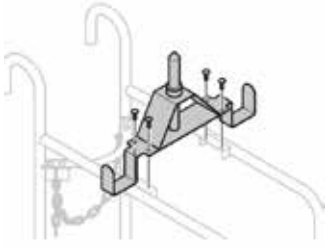

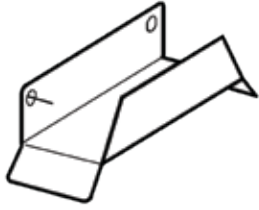
Wire Feeder Accessories

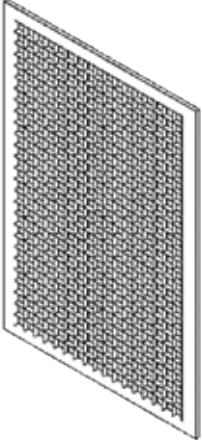
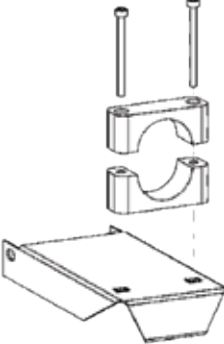
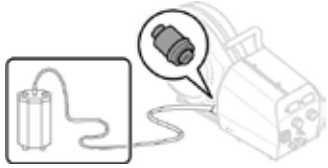
 <p><b>Robust Feed Wheel Kit</b> Part Number: 0446081880</p> <p>Increases the working radius from the power source. The wheel kit has four wheels and can also be placed to pivot on the power source.</p>	 <p><b>Miggytrac/Railtrac Remote Adapter for CAN feeders MA23, MA24, U6, U8, Plus</b> Part Number: 0459681880</p>	 <p><b>1 - Spool Holder</b> Part Number: 0458704880</p> <p><b>2- Adapter for 11-lb (5 kg) Spool</b> Part Number: 0455410001</p>	 <p><b>Warrior Trolley Guide Pin Extension</b> Part Number: 0465508880</p> <p>For use with Wheel Kit.</p>
 <p><b>Electrode Holder Assembly QD</b> Part Number: 21226</p>	 <p><b>Quick Connector Marathon Pac</b> Part Number: 0558002354</p> <p>Allows connection of QCA Adapter to Aristo Feed inlet.</p>	 <p><b>Cable and Torch Holder</b> Part Number: 0349303362</p>	 <p><b>Remote Connection Cable for CAN</b> Part Number: 0459960880</p> <p>(Requires MTA or M1 10Prog CAN remote) CAN 4 pole - 10 pole 16.4 ft. (5 m).</p>
 <p><b>Foot pedal T1 Foot CAN</b> Part Number: 0460315881</p> <p>incl. 16.4 ft. (5 m) cable with 10 pole plug, for connection to the feeder with U6 panel.</p> <p>Part Number: 0460315880</p> <p>incl. 16.4 ft. (5 m) cable with 12 pole plug, for connection to the feeder for U8, Plus.</p>	 <p><b>Air Filter</b> Part Number: 0349302252</p> <p>Cleanable/reusable, optional filter. Extends time between required maintenance and protects components in harsh environments. For use with Origo Mig 4002c/5002cw/6502c.</p>	 <p><b>Power Source Strain Relief for Connection Cables</b> Part Number: 0349311700</p> <p>Recommended when moving power supply frequently and use of long connection sets.</p>	 <p><b>Quick Connector Bushing Marathon Pac</b> Part Number: 0558002354</p> <p>Allows use of p/n 899F50 QCA Fitting.</p>

WIRE FEEDERS

## MiniBoom Assembly

- Up to 25 ft. (7.6 m) working radius – effective area of over 1900 sq ft. (579 m<sup>2</sup>)
- 350° working envelope
- Mounts easily to power source,
- inverter cart or stationary pedestal
- Adjustable boom length
- Adjustable counterbalance spring
- Feed 304/3004 only

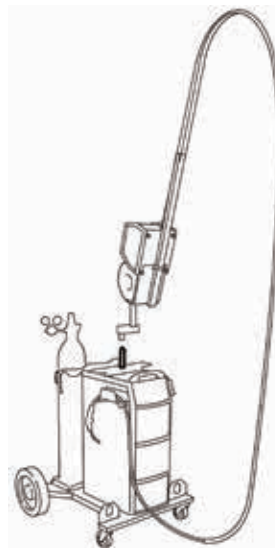

### Ordering Information

MiniBoom for Spools (12")	0458705880
MiniBoom for Coils (18")	0458705882

\*Use with accessories listed for Trolley/power source used.

## Balanced Boom Assembly

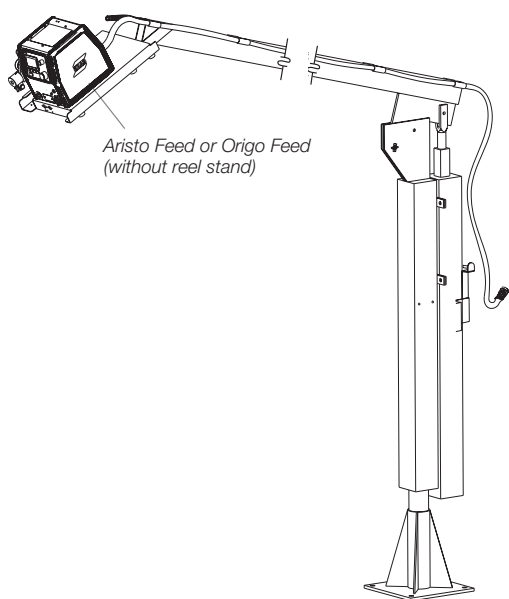

- Extends a 12 ft. (4 m) or 15 ft. (4.5 m) torch's reach from a 20 ft. (6 m) radius up to a 31 ft. (9.5 m) radius
- 350° envelope of operation in most uses
- Boom adjusts from 50° up to 6° down from horizontal position, can be used for tall weldments
- Fully balances feeder weight for fingertip control of feeder height, no lever jacking
- Mast has 6.5 ft. (2 m) clearance from floor to boom support pin
- Standard mounting directly to concrete floor
- Pallet and cart mounting options available
- Extremely rugged steel construction for years of continuous use
- Weld parameters easily adjustable on the standard feeder at the end of boom
- Wire spools mountable to mast or feed wire from Marathon Pac

### Options & Accessories

8 ft. (2.4 m), Plastic Trough	0558004004
12 ft. (3.6 m), Plastic Trough	0558003447
Boom mounting bracket <sup>1</sup>	0558005581
ERS conduit bushing support bracket <sup>2</sup>	37770
Coil adapter for 60-lb (27-kg) coils	34323
Welding cart with wheels <sup>5</sup>	37777
10 ft. (3 m), Plastic Trough	0558004008
16.4 ft. (5 m), Plastic Trough	0558003732
Feeder strain relief for torch <sup>1</sup>	0457341881
Spindle assembly <sup>3</sup>	948259
Pallet base <sup>4</sup>	37776
Inlet guide, 0.2-1 in. (4-30 mm), Marathon Pac <sup>6</sup>	0558002354

### Ordering Information

8 ft. (2.4 m), B-8/FHD	0558004002
12 ft. (3.6 m), B-12/FHD	0558003734
10 ft. (3 m), B-10/FHD	0558004006
16.4 ft. (5 m), B-16/FHD	0558003737

Typical wire feeder

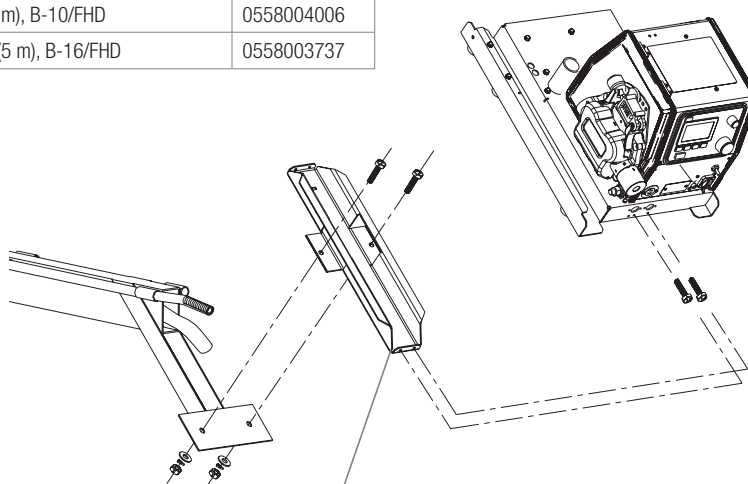

Typical wire feeder mounting bracket

<sup>1</sup>For Origo Feed and Aristo Feed wire feeders.

<sup>2</sup>Used with spindle assembly #948259 (holds conduit inlet inline with spool).

<sup>3</sup>For mast mounted spools - requires 1/4 in. hardware.

<sup>4</sup>Requires anchoring to floor in-use.

<sup>5</sup>Use with 12 ft. maximum boom and 300+ lbs. power source.

<sup>6</sup>Accepts QCA adapter #899F50.

## EASY FIND GUIDE – MIG Gun Selection Guide



Wire Diameter	Amperage Range												Recommended	Alternate				
	30	100	150	200	250	300	350	400	450	500	550	600			650			
<b>Solid Wire – Mild Steel and Stainless Steel</b> .023" - .030" (0.6 - 0.8 mm)	CO <sub>2</sub>		75-25														Fusion 180, Mini-MIG 160, VELOCITY2 Mini-MIG 160	VELOCITY2 Classic No. 1, Classic No. 1
.035" (0.9 mm)	CO <sub>2</sub>		75-25														Fusion 180, VELOCITY2 Spray Master SMV250, Spray Master 250	VELOCITY2 Classic No. 2, Classic No. 2, Smoke Master 250, Compact Eliminator 250
.045" (1.2 mm)	CO <sub>2</sub>		Higher Argon Mixture														VELOCITY2 Spray Master SMV350, Spray Master 350, VELOCITY2 Classic No. 4, Classic No. 4	VELOCITY2 Supra XT 400, Supra XT 400, Smoke Master 450
.052" (1.3 mm)			Higher Argon Mixture														VELOCITY2 Spray Master SMV450, Spray Master 450, VELOCITY2 Classic No. 4, Classic No. 4	VELOCITY2 Supra XT 400, Supra XT 400, Smoke Master 450
1/16" (1.6 mm)			Higher Argon Mixture														VELOCITY2 Spray Master SMV450, Spray Master 450, VELOCITY2 Classic No. 5, Classic No. 5	PulseMaster 500 Water-Cooled, Standard Water-Cooled 600

Wire Diameter	Amperage Range												Recommended	Alternate				
	30	100	150	200	250	300	350	400	450	500	550	600			650			
<b>Flux Cored Wire</b> 030" (0.8 mm)	Self-shielded												Fusion 180, Mini-MIG 160, VELOCITY2 Mini-MIG 160	VELOCITY2 Classic No. 1, Classic No. 1				
.035" (0.9 mm)	Self-shielded		CO <sub>2</sub> or 75-25														Fusion 180, VELOCITY2 Spray Master SMV250, Spray Master 250	VELOCITY2 Classic No. 2, Classic No. 2, Smoke Master 250, Compact Eliminator 250
.045" (1.2 mm)	Self-shielded		CO <sub>2</sub> or 75-25														VELOCITY2 Spray Master SMV350, Spray Master 350, VELOCITY2 Classic No. 4, Classic No. 4	VELOCITY2 Supra XT 400, Supra XT 400, Smoke Master 450
.052" (1.3 mm)			CO <sub>2</sub> or 75-25														VELOCITY2 Spray Master SMV450, Spray Master 450, VELOCITY2 Classic No. 4, Classic No. 4	VELOCITY2 Supra XT 400, Supra XT 400, Smoke Master 450
1/16" - 5/64" (1.6 - 2.0 mm)	Self-shielded												VELOCITY2 Spray Master SMV450, Spray Master 450, VELOCITY2 Classic No. 5, Classic No. 5	PulseMaster 500 Water-Cooled, Standard Water-Cooled 600				
3/32" (2.4 mm)	Self-shielded		CO <sub>2</sub> or 75-25														VELOCITY2 Classic No. 6, Classic No. 6	VELOCITY2 Classic No. 5, Classic No. 5

\*Flux Cored SEFC Series MIG Guns are to be used only with Self-Shielded wire

Wire Diameter	Amperage Range												Recommended	Alternate		
	30	100	150	200	250	300	350	400	450	500	550	600			650	
<b>Solid Wire – Aluminum</b> .030" (0.8 mm)	Argon														Spool Gun 160 & 200, Fusion 180	VELOCITY2 Classic No. 1, Classic No. 1
.035" (0.9 mm)	Argon														Spool Gun 200, VELOCITY2 Spray Master 250, Spray Master 250	VELOCITY2 Classic No. 2, Classic No. 2
3/64" (1.2 mm)	Argon														VELOCITY2 Spray Master SMV350, Spray Master 350, VELOCITY2 Classic No. 3, Classic No. 3	VELOCITY2 Spray Master SMV450, VELOCITY2 Classic No. 4, Classic No. 4
1/16" (1.6 mm)	Argon														VELOCITY2 Spray Master SMV450, Spray Master 450	PulseMaster 500 Water-Cooled

When welding with aluminum wire, standard MIG gun length of 12 ft should not be exceeded and conduit liners/contact tips made specifically for aluminum wires should be used.

MIG GUNS & TIG TORCHES

# EASY FIND GUIDE – MIG Gun Selection Guide



Tweco MIG Gun	Amperage Range	Available Lengths ft (m)	Handle Design	Cablehoz Connection	Rear End Connector Options	Air-Cooled/ Water-Cooled	Special Features
Spray Master® Series	250, 350, 450	10, 12, 15, 20, 25 ft (3, 3.7, 4.6, 6.1, 7.6 m)	Small & Ergonomic	Crimped	Tweco, Miller®, Lincoln®, Euro-Kwik	Air	Heavy Duty Front End Consumables
VELOCITY2™ Spray Master® Series	250, 350, 450	10, 12, 15, 20, 25 ft (3, 3.7, 4.6, 6.1, 7.6 m)	Small & Ergonomic	Crimped	Tweco, Miller, Lincoln, Euro-Kwik	Air	Heavy Duty Front End Consumables
Classic® No. Series	180, 200, 300, 400, 500, 600	10, 12, 15, 20, 25 ft (3, 3.7, 4.6, 6.1, 7.6 m)	Oval/Paddle Contour	Mechanical	Tweco, Miller, Lincoln, Euro-Kwik	Air	Wide Range of Front End Consumables
VELOCITY2™ Classic® No. Series	180, 200, 300, 400, 500	10, 12, 15, 20, 25 ft (3, 3.7, 4.6, 6.1, 7.6 m)	Oval/Paddle Contour	Mechanical	Tweco, Miller, Lincoln, Euro-Kwik	Air	Wide Range of Front End Consumables
Fusion® Series	180	10, 12, 15 ft (3, 3.7, 4.6 m)	Small & Ergonomic	Crimped	Tweco, Miller, Lincoln, Euro-Kwik	Air	Longer Life Velocity Consumables
Compact Eliminator®	250, 450	10, 12, 15, 20, 25 ft (3, 3.7, 4.6, 6.1, 7.6 m)	Small & Ergonomic	Crimped	Tweco, Miller, Euro-Kwik	Air	Ball & Socket design conductor tube & cam style locking contact tips
Mini-MIG	160	10, 12, 15 ft (3, 3.7, 4.6 m)	Straight	Mechanical	Tweco, Miller, Lincoln, Euro-Kwik	Air	Wide Selection of Front End Consumables Available
VELOCITY2™ Mini-MIG	160	10, 12, 15 ft (3, 3.7, 4.6 m)	Straight	Mechanical	Tweco, Miller, Lincoln, Euro-Kwik	Air	Wide Selection of Front End Consumables Available
Supra® XT	400	15 ft (4.6 m)	Straight	Mechanical	Tweco, Miller, Lincoln	Air	Top Trigger Capability
VELOCITY2™ Supra® XT	400	15, 25 ft (4.6, 7.6 m)	Straight	Mechanical	Tweco, Miller, Lincoln	Air	Top Trigger Capability
Smoke Master® Series	250, 450	15 ft (4.6 m)	Ergonomic	Crimped	Tweco, Miller, Lincoln	Air	Fume Extraction Cam-Style Contact Tips
Flux Cored SEFC Series	450	10, 15 ft (3, 4.6 m)	Straight	Crimped	Tweco, Miller, Lincoln	Air	Galvanized Steel Inner Core Tube Cablehoz Design
Spool Gun Series	160, 200	12, 25 ft (3.7, 7.6 m)	Pistol Grip	Mechanical	Dinse Lug	Air	Accepts Standard 4" Spools Rotatable Wire Spool Housing
PulseMaster® Series	400, 500	12, 25 ft (3.7, 7.6 m)	Ergonomic	Crimped	Tweco	Water	Smart Option or Standard
Standard Water-Cooled	600	15 ft (4.6 m)	Ergonomic	Crimped	Tweco	Water	Inert Gas Style Fitting

For Special MIG gun configurations, including special consumables, please contact Tech Service and Support.

Adapter kits are available to fit Tweco rear connection to most wire feeders.

Some Lincoln wire feeders are assembled with their K1500-2 gun receiving bushing that will accept Tweco Style MIG Guns direct from the factory. Control wire (2060-2137) must be ordered separately.

Miller is a registered trademark of Illinois Tool Works, Inc. Lincoln is a registered trademark of Lincoln Electric Co. The aforementioned registered trademarks are in no way affiliated with Tweco. Tweco is registered trademark of ESAB.

MIG GUNS & TIG TORCHES

## Tweco Spray Master 250 Amp MIG Gun

Suitable for Light/Medium Duty Fabrication



Standard Options Include:

- Rear Connector and Knucklehead™ Flexible Conductor Tube
- Standard Conductor Tube – (1630-1189) on all guns up to 15 ft. (4.6 m), (1630-1188) on all guns over 15 ft. (4.6 m)
- Conduit Liner – 42 Series

Specifications					
Rated Output	Gas	Wire Size	Cooled	Process	Application Usage
250 A @ 80% duty cycle	Mixed	up to .045 in. (1.2 mm)	Air	GMAW, AI, FCAW	light/medium-duty fabrication

Ordering Information					
Tweco Style Rear Connector		Miller Style Rear Connector		Euro-Kwik Style Rear Connector	
12 ft. (3.6 m), .045 in. (1.2 mm)	1023-1101	10 ft. (3 m), .045 in. (1.2 mm)	1023-1110	12 ft. (3.6 m), .045 in. (1.2 mm)	1023-1126
15 ft. (4.6 m), .045 in. (1.2 mm)	1023-1102	12 ft. (3.6 m), .045 in. (1.2 mm)	1023-1111	15 ft. (4.6 m), .045 in. (1.2 mm)	1023-1127
20 ft. (6.1 m), .045 in. (1.2 mm)	1023-1103	15 ft. (4.6 m), .045 in. (1.2 mm)	1023-1112	25 ft. (7.6 m), .045 in. (1.2 mm)	1023-1133
25 ft. (7.6 m), .045 in. (1.2 mm)	1023-1108	20 ft. (6.1 m), .045 in. (1.2 mm)	1023-1113	<b>Lincoln Style Rear Connector</b>	
<b>Tweco Style (8-pin) Rear Connector</b>		25 ft. (7.6 m), .045 in. (1.2 mm)	1023-1118	12 ft. (3.6 m), .045 in. (1.2 mm)	1023-1136
12 ft. (3.6 m), .045 in. (1.2 mm)	1023-1141				
15 ft. (4.6 m), .045 in. (1.2 mm)	1023-1140				

## Tweco Spray Master 350 Amp MIG Gun

Suitable for Medium/Heavy Duty Fabrication



Standard Options Include:

- Dual Schedule On/Off Control, Rear Connector and Knucklehead™ Flexible Conductor Tube
- Standard Conductor Tube – (1630-1189) on all guns up to 15 ft. (4.6 m), (1630-1188) on all guns over 15 ft. (4.6 m)
- Conduit Liner – 44 Series

Specifications					
Rated Output	Gas	Wire Size	Cooled	Process	Application Usage
350 A @ 80% duty cycle	Mixed	up to 1/16 in. (1.6 mm)	Air	GMAW, AI, FCAW	medium/heavy-duty fabrication

Ordering Information					
Tweco Style Rear Connector		Miller Style Rear Connector		Lincoln Style Rear Connector	
10 ft. (3 m), 1/16 in. (1.6 mm)	1036-1610	10 ft. (3 m), 1/16 in. (1.6 mm)	1036-1635	12 ft. (3.6 m), 1/16 in. (1.6 mm)	1036-1646
12 ft. (3.6 m), 1/16 in. (1.6 mm)	1036-1613	12 ft. (3.6 m), 1/16 in. (1.6 mm)	1036-1638	15 ft. (4.6 m), 1/16 in. (1.6 mm)	1036-1647
15 ft. (4.6 m), 1/16 in. (1.6 mm)	1036-1615	15 ft. (4.6 m), 1/16 in. (1.6 mm)	1036-1640		
<b>Euro-Kwik Style Rear Connector</b>		25 ft. (7.6 m), 1/16 in. (1.6 mm)	1036-1642		
15 ft. (4.6 m), 1/16 in. (1.6 mm)	1036-1623				

## Tweco Spray Master 450 Amp MIG Gun

Suitable for Heavy Duty Fabrication



Standard Options Include:

- Dual Schedule On/Off Control, Locking Trigger, Rear Connector and Knucklehead™ Flexible Conductor Tube
- Standard Conductor Tube – (1640-1319) on all guns up to 15 ft. (4.6 m), (1630-1318) on all guns over 15 ft. (4.6 m)
- Conduit Liner – 44 Series

Specifications					
Rated Output	Gas	Wire Size	Cooled	Process	Application Usage
450 A @ 80% duty cycle	Mixed	up to 1/16 in. (1.6 mm)	Air	GMAW, AI, FCAW	heavy-duty fabrication

Ordering Information							
Tweco Style Rear Connector		Miller Style Rear Connector		Lincoln Style Rear Connector		Euro-Kwik Style Rear Connector	
10 ft. (3 m), 1/16 in. (1.6 mm)	1040-1050	10 ft. (3 m), 1/16 in. (1.6 mm)	1040-1060	10 ft. (3 m), 1/16 in. (1.6 mm)	1040-1070	10 ft. (3 m), 1/16 in. (1.6 mm)	1040-1075
12 ft. (3.6 m), 1/16 in. (1.6 mm)	1040-1051	12 ft. (3.6 m), 1/16 in. (1.6 mm)	1040-1061	15 ft. (4.6 m), 1/16 in. (1.6 mm)	1040-1072	12 ft. (3.6 m), 1/16 in. (1.6 mm)	1040-1076
15 ft. (4.6 m), 1/16 in. (1.6 mm)	1040-1052	15 ft. (4.6 m), 1/16 in. (1.6 mm)	1040-1062	25 ft. (7.6 m), 1/16 in. (1.6 mm)	1040-1071	15 ft. (4.6 m), 1/16 in. (1.6 mm)	1040-1077
20 ft. (6.1 m), 1/16 in. (1.6 mm)	1040-1059	20 ft. (6.1 m), 1/16 in. (1.6 mm)	1040-1064				
25 ft. (7.6 m), 1/16 in. (1.6 mm)	1040-1058	25 ft. (7.6 m), 1/16 in. (1.6 mm)	1040-1068				

## Tweco Spray Master Velocity2 V250 Amp MIG Gun

Suitable for Light/Medium Duty Fabrication



Standard Options Include:

- Rear Connector and Knucklehead™ Flexible Conductor Tube
- Standard Conductor Tube – (1240-1374) on all guns up to 15 ft. (4.6 m), (1240-1373) on all guns over 15 ft. (4.6 m)
- Conduit Liner – 42 Series

Specifications					
Rated Output	Gas	Wire Size	Cooled	Process	Application Usage
250 A @ 80% duty cycle	Mixed	up to .045 in. (1.2 mm)	Air	GMAW, AI, FCAW	light/medium-duty fabrication

Ordering Information							
Tweco® Style Rear Connector		Miller Style Rear Connector		Lincoln Style Rear Connector		Euro-Kwik Style Rear Connector	
10 ft. (3 m), .045 in. (1.2 mm)	1023-1290	10 ft. (3 m), .045 in. (1.2 mm)	1023-1280	10 ft. (3 m), .045 in. (1.2 mm)	1023-1292	10 ft. (3 m), .045 in. (1.2 mm)	1023-1286
12 ft. (3.6 m), .045 in. (1.2 mm)	1023-1276	12 ft. (3.6 m), .045 in. (1.2 mm)	1023-1281	12 ft. (3.6 m), .045 in. (1.2 mm)	1023-1285	12 ft. (3.6 m), .045 in. (1.2 mm)	1023-1287
15 ft. (4.6 m), .045 in. (1.2 mm)	1023-1277	15 ft. (4.6 m), .045 in. (1.2 mm)	1023-1282	15 ft. (4.6 m), .045 in. (1.2 mm)	1023-1293	15 ft. (4.6 m), .045 in. (1.2 mm)	1023-1288
20 ft. (6.1 m), .045 in. (1.2 mm)	1023-1278	20 ft. (6.1 m), .045 in. (1.2 mm)	1023-1283	20 ft. (6.1 m), .045 in. (1.2 mm)	1023-1294	20 ft. (6.1 m), .045 in. (1.2 mm)	1023-1291
25 ft. (7.6 m), .045 in. (1.2 mm)	1023-1279	25 ft. (7.6 m), .045 in. (1.2 mm)	1023-1289	25 ft. (7.6 m), .045 in. (1.2 mm)	1023-1295	25 ft. (7.6 m), .045 in. (1.2 mm)	1023-1284

## Tweco Spray Master Velocity2 V350 Amp MIG Gun

Suitable for Medium/Heavy Duty Fabrication



Standard Options Include:

- Dual Schedule On/Off Control, Rear Connector and Knucklehead™ Flexible Conductor Tube
- Standard Conductor Tube – Part No. SMVCT-60 (Stock No. 1240-1374) on all guns up to 15ft (4.6 m)
- Part No. SMVCT-45 (Stock No. 1240-1373) on all guns over 15 ft (4.6 m)
- Conduit Liner – 42 Series

Specifications					
Rated Output	Gas	Wire Size	Cooled	Process	Application Usage
350 A @ 80% duty cycle	Mixed	up to 1/16 in. (1.6 mm)	Air	GMAW, AI, FCAW	medium/heavy-duty fabrication

Ordering Information							
Tweco Style Rear Connector		Miller Style Rear Connector		Lincoln Style Rear Connector		Euro-Kwik Style Rear Connector	
10 ft. (3 m), 1/16 in. (1.6 mm)	1036-1750	10 ft. (3 m), 1/16 in. (1.6 mm)	1036-1751	10 ft. (3 m), 1/16 in. (1.6 mm)	1036-1785	10 ft. (3 m), 1/16 in. (1.6 mm)	1036-1784
12 ft. (3.6 m), 1/16 in. (1.6 mm)	1036-1752	12 ft. (3.6 m), 1/16 in. (1.6 mm)	1036-1754	12 ft. (3.6 m), 1/16 in. (1.6 mm)	1036-1753	12 ft. (3.6 m), 1/16 in. (1.6 mm)	1036-1779
15 ft. (4.6 m), 1/16 in. (1.6 mm)	1036-1756	15 ft. (4.6 m), 1/16 in. (1.6 mm)	1036-1765	15 ft. (4.6 m), 1/16 in. (1.6 mm)	1036-1762	15 ft. (4.6 m), 1/16 in. (1.6 mm)	1036-1770
20 ft. (6.1 m), 1/16 in. (1.6 mm)	1036-1789	20 ft. (6.1 m), 1/16 in. (1.6 mm)	1036-1780	20 ft. (6.1 m), 1/16 in. (1.6 mm)	1036-1781	20 ft. (6.1 m), 1/16 in. (1.6 mm)	1036-1782
25 ft. (7.6 m), 1/16 in. (1.6 mm)	1036-1787	25 ft. (7.6 m), 1/16 in. (1.6 mm)	1036-1775	25 ft. (7.6 m), 1/16 in. (1.6 mm)	1036-1786	25 ft. (7.6 m), 1/16 in. (1.6 mm)	1036-1790

## Tweco Spray Master Velocity2 V450 Amp MIG Gun

Suitable for Heavy Duty Fabrication



Standard Options Include:

- Dual Schedule On/Off Control, Locking Trigger, Rear Connector and Knucklehead™ Flexible Conductor Tube
- Standard Conductor Tube – (1240-1374) on all guns up to 15 ft. (4.6 m), (1240-1373) on all guns over 15 ft. (4.6 m)
- Conduit Liner – 44 Series

Specifications					
Rated Output	Gas	Wire Size	Cooled	Process	Application Usage
450 A @ 80% duty cycle	Mixed	up to 1/16 in. (1.6 mm)	Air	GMAW, AI, FCAW	heavy-duty fabrication

Ordering Information							
Tweco Style Rear Connector		Miller Style Rear Connector		Lincoln Style Rear Connector		Euro-Kwik Style Rear Connector	
10 ft. (3 m), 1/16 in. (1.6 mm)	1040-1825	10 ft. (3 m), 1/16 in. (1.6 mm)	1040-1827	10 ft. (3 m), 1/16 in. (1.6 mm)	1040-1826	10 ft. (3 m), 1/16 in. (1.6 mm)	1040-1828
12 ft. (3.6 m), 1/16 in. (1.6 mm)	1040-1829	12 ft. (3.6 m), 1/16 in. (1.6 mm)	1040-1830	12 ft. (3.6 m), 1/16 in. (1.6 mm)	1040-1866	12 ft. (3.6 m), 1/16 in. (1.6 mm)	1040-1832
15 ft. (4.6 m), 1/16 in. (1.6 mm)	1040-1833	15 ft. (4.6 m), 1/16 in. (1.6 mm)	1040-1844	15 ft. (4.6 m), 1/16 in. (1.6 mm)	1040-1839	15 ft. (4.6 m), 1/16 in. (1.6 mm)	1040-1850
20 ft. (6.1 m), 1/16 in. (1.6 mm)	1040-1854	20 ft. (6.1 m), 1/16 in. (1.6 mm)	1040-1855	20 ft. (6.1 m), 1/16 in. (1.6 mm)	1040-1869	20 ft. (6.1 m), 1/16 in. (1.6 mm)	1040-1867
25 ft. (7.6 m), 1/16 in. (1.6 mm)	1040-1859	25 ft. (7.6 m), 1/16 in. (1.6 mm)	1040-1861	25 ft. (7.6 m), 1/16 in. (1.6 mm)	1040-1860	25 ft. (7.6 m), 1/16 in. (1.6 mm)	1040-1868

MIG GUNS & TIG TORCHES



## Tweco Classic No. 1 180 Amp MIG Gun

Suitable for Light Duty Fabrication



Standard Options Include:

- Rear Connector
- Standard Conductor Tube – (1610-1102) on all guns up to 15 ft. (4.6 m), (1610-1101) on all guns over 15 ft. (4.6 m)
- Conduit Liner – 42 Series

Specifications					
Rated Output	Gas	Wire Size	Cooled	Process	Application Usage
180 A @ 60% duty cycle	CO <sub>2</sub>	up to .045 in. (1.2 mm)	Air	GMAW, AI	light-duty fabrication

Ordering Information			
Tweco Style Rear Connector		Miller Style Rear Connector	
10 ft. (3 m), .035 in. (0.9 mm)	1010-1111	10 ft. (3 m), .035 in. (0.9 mm)	1010-1131
12 ft. (3.6 m), .035 in. (0.9 mm)	1010-1112	12 ft. (3.6 m), .035 in. (0.9 mm)	1010-1133
15 ft. (4.6 m), .035 in. (0.9 mm)	1010-1113	15 ft. (4.6 m), .035 in. (0.9 mm)	1010-1135
20 ft. (6.1 m), .035 in. (0.9 mm)	1010-1114	Lincoln Style Rear Connector	
10 ft. (3 m), .045 in. (1.2 mm)	1010-1121	15 ft. (4.6 m), .035 in. (0.9 mm)	1010-1145
12 ft. (3.6 m), .045 in. (1.2 mm)	1010-1122	Euro-Kwik Style Rear Connector	
15 ft. (4.6 m), .045 in. (1.2 mm)	1010-1123	10 ft. (3 m), .045 in. (1.2 mm)	1010-1621
20 ft. (6.1 m), .045 in. (1.2 mm)	1010-1124	12 ft. (3.6 m), .045 in. (1.2 mm)	1010-1622

## Tweco Classic No. 2 200 Amp MIG Gun

Suitable for Medium Duty Fabrication



Standard Options Include:

- Rear Connector and Knucklehead™ Flexible Conductor Tube
- Standard Conductor Tube – (1620-1301) on all guns up to 15 ft. (4.6 m), (1620-1300) on all guns over 15 ft. (4.6 m)
- Conduit Liner – 42 Series

Specifications					
Rated Output	Gas	Wire Size	Cooled	Process	Application Usage
200 A @ 60% duty cycle	CO <sub>2</sub>	up to .045 in. (1.2 mm)	Air	GMAW, AI	medium-duty fabrication

Ordering Information					
Tweco Style Rear Connector		Miller Style Rear Connector		Lincoln Style Rear Connector	
10 ft. (3 m), .035 in. (0.9 mm)	1020-1111	10 ft. (3 m), .035 in. (0.9 mm)	1020-1130	10 ft. (3 m), .035 in. (0.9 mm)	1020-1140
12 ft. (3.6 m), .035 in. (0.9 mm)	1020-1112	12 ft. (3.6 m), .035 in. (0.9 mm)	1020-1132	12 ft. (3.6 m), .035 in. (0.9 mm)	1020-1142
15 ft. (4.6 m), .035 in. (0.9 mm)	1020-1113	15 ft. (4.6 m), .035 in. (0.9 mm)	1020-1134	15 ft. (4.6 m), .035 in. (0.9 mm)	1020-1144
20 ft. (6.1 m), .035 in. (0.9 mm)	1020-1114	10 ft. (3 m), .045 in. (1.2 mm)	1020-1131	Euro-Kwik Style Rear Connector	
25 ft. (7.6 m), .035 in. (0.9 mm)	1020-1115	12 ft. (3.6 m), .045 in. (1.2 mm)	1020-1133	12 ft. (3.6 m), .045 in. (1.2 mm)	1020-1622
10 ft. (3 m), .045 in. (1.2 mm)	1020-1121	15 ft. (4.6 m), .045 in. (1.2 mm)	1020-1135	15 ft. (4.6 m), .045 in. (1.2 mm)	1020-1623
12 ft. (3.6 m), .045 in. (1.2 mm)	1020-1322	15 ft. (4.6 m), .045 in. (1.2 mm)	1020-1661*		
15 ft. (4.6 m), .045 in. (1.2 mm)	1020-1123	*Knucklehead Conductor Tube (1620-1106)			
20 ft. (6.1 m), .045 in. (1.2 mm)	1020-1660				
25 ft. (7.6 m), .045 in. (1.2 mm)	1020-1125				

## Tweco Classic No. 3 300 Amp MIG Gun

Suitable for Medium/Heavy Duty Fabrication



Standard Options Include:

- Rear Connector
- Standard Conductor Tube – Part No. 63J-60 (Stock No. 1630-1111) on all guns up to 15 ft. (4.6 m)
- Part No. 63J-45 (Stock No. 1630-1110) on all guns over 15 ft. (4.6 m)
- Conduit Liner – 44 Series

### Specifications

Rated Output	Gas	Wire Size	Cooled	Process	Application Usage
300 A @ 60% duty cycle	CO <sub>2</sub>	up to 1/16 in. (1.6 mm)	Air	GMAW, AI	medium/heavy-duty fabrication

### Ordering Information

Tweco Style Rear Connector		Miller Style Rear Connector		Lincoln Style Rear Connector		Euro-Kwik Style Rear Connector	
10 ft. (3 m), .045 in. (1.2 mm)	1030-1101	10 ft. (3 m), .045 in. (1.2 mm)	1030-1130	10 ft. (3 m), .045 in. (1.2 mm)	1030-1140	10 ft. (3 m), .045 in. (1.2 mm)	1030-1601
12 ft. (3.6 m), .045 in. (1.2 mm)	1030-1102	12 ft. (3.6 m), .045 in. (1.2 mm)	1030-1133	12 ft. (3.6 m), .045 in. (1.2 mm)	1030-1143	12 ft. (3.6 m), .045 in. (1.2 mm)	1030-1602
15 ft. (4.6 m), .045 in. (1.2 mm)	1030-1103	15 ft. (4.6 m), .045 in. (1.2 mm)	1030-1136	15 ft. (4.6 m), .045 in. (1.2 mm)	1030-1146		
20 ft. (6.1 m), .045 in. (1.2 mm)	1030-1104	15 ft. (4.6 m), 1/16 in. (1.6 mm)	1030-1137				
25 ft. (7.6 m), .045 in. (1.2 mm)	1030-1105						
15 ft. (4.6 m), 1/16 in. (1.6 mm)	1030-1113						
25 ft. (7.6 m), 1/16 in. (1.6 mm)	1030-1115						

## Tweco Classic No. 4 400 Amp MIG Gun

Suitable for Heavy Duty Fabrication



Standard Options Include:

- Dual Schedule On/Off Control, Rear Connector and Knucklehead™ Flexible Conductor Tube
- Standard Conductor Tube – (1640-1106) on all guns up to 15 ft. (4.6 m), (1640-1105) on all guns over 15 ft. (4.6 m)
- Conduit Liner – 44 Series

### Specifications

Rated Output	Gas	Wire Size	Cooled	Process	Application Usage
400 A @ 60% duty cycle	CO <sub>2</sub>	up to 1/16 in. (1.6 mm)	Air	GMAW, AI, FCAW	heavy-duty fabrication

### Ordering Information

Tweco Style Rear Connector		Miller Style Rear Connector		Lincoln Style Rear Connector	
10 ft. (3 m), .035 in. (0.9 mm)	1040-1101	10 ft. (3 m), .035 in. (0.9 mm)	1040-1130	10 ft. (3 m), .035 in. (0.9 mm)	1040-1140
12 ft. (3.6 m), .035 in. (0.9 mm)	1040-1102	12 ft. (3.6 m), .035 in. (0.9 mm)	1040-1133	12 ft. (3.6 m), .035 in. (0.9 mm)	1040-1143
15 ft. (4.6 m), .035 in. (0.9 mm)	1040-1103	15 ft. (4.6 m), .035 in. (0.9 mm)	1040-1136	15 ft. (4.6 m), .035 in. (0.9 mm)	1040-1146
15 ft. (4.6 m), .035 in. (0.9 mm)	1040-1503 <sup>1</sup>	15 ft. (4.6 m), .035 in. (0.9 mm)	1040-1688 <sup>2</sup>	15 ft. (4.6 m), .035 in. (0.9 mm)	1040-1689 <sup>2</sup>
20 ft. (6.1 m), .035 in. (0.9 mm)	1040-1104	20 ft. (6.1 m), .035 in. (0.9 mm)	1040-1126	10 ft. (3 m), .045 in. (1.2 mm)	1040-1141
25 ft. (7.6 m), .035 in. (0.9 mm)	1040-1105	25 ft. (7.6 m), .035 in. (0.9 mm)	1040-1129	12 ft. (3.6 m), .045 in. (1.2 mm)	1040-1144
10 ft. (3 m), .045 in. (1.2 mm)	1040-1111	10 ft. (3 m), .045 in. (1.2 mm)	1040-1131	15 ft. (4.6 m), .045 in. (1.2 mm)	1040-1147
12 ft. (3.6 m), .045 in. (1.2 mm)	1040-1112	12 ft. (3.6 m), .045 in. (1.2 mm)	1040-1134	<b>Euro-Kwik Style Rear Connector</b>	
15 ft. (4.6 m), .045 in. (1.2 mm)	1040-1113	15 ft. (4.6 m), .045 in. (1.2 mm)	1040-1137	12 ft. (3.6 m), .035 in. (0.9 mm)	1040-1602
20 ft. (6.1 m), .045 in. (1.2 mm)	1040-1114	20 ft. (6.1 m), .045 in. (1.2 mm)	1040-1127	15 ft. (4.6 m), .035 in. (0.9 mm)	1040-1603
25 ft. (7.6 m), .045 in. (1.2 mm)	1040-1115	25 ft. (7.6 m), .045 in. (1.2 mm)	1040-1128	25 ft. (7.6 m), .035 in. (0.9 mm)	1040-1605
15 ft. (4.6 m), 1/16 in. (1.6 mm)	1040-1514 <sup>1</sup>	15 ft. (4.6 m), 5/64 in. (2.0 mm)	1040-1138	15 ft. (4.6 m), .045 in. (1.2 mm)	1040-1613
15 ft. (4.6 m), 5/64 in. (2.0 mm)	1040-1123				

<sup>1</sup> = Dual Schedule <sup>2</sup> = Knucklehead Conductor Tube – 1640-1113

## Tweco Classic No. 5 500 Amp MIG Gun

Suitable for Heavy Duty Fabrication



Standard Options Include:

- Dual Schedule On/Off Control, Locking Trigger & Rear Connector
- Standard Conductor Tube – (1650-1111) on all guns up to 15 ft. (4.6 m), (1650-1110) on all guns over 15 ft. (4.6 m)
- Conduit Liner – 45 Series

Specifications					
Rated Output	Gas	Wire Size	Cooled	Process	Application Usage
500 A @ 60% duty cycle	CO <sub>2</sub>	up to 3/32 in. (2.4 mm)	Air	GMAW, AI, FCAW	heavy-duty fabrication

Ordering Information					
Tweco Style Rear Connector		Miller Style Rear Connector		Lincoln Style Rear Connector	
15 ft. (4.6 m), 1/16 in. (1.6 mm)	1050-1113	15 ft. (4.6 m), 1/16 in. (1.6 mm)	1050-1173	15 ft. (4.6 m), 3/32 in. (2.4 mm)	1050-1642
25 ft. (7.6 m), 1/16 in. (1.6 mm)	1050-1115	15 ft. (4.6 m), 3/32 in. (2.4 mm)	1050-1175		
10 ft. (3 m), 3/32 in. (2.4 mm)	1050-1131				
15 ft. (4.6 m), 3/32 in. (2.4 mm)	1050-1133				

## Tweco Velocity2 Classic No. 1 180 Amp MIG Gun

Suitable for Light Duty Fabrication



Standard Options Include:

- Rear Connector
- Standard Conductor Tube – (1610-1102) on all guns over 15 ft. (4.6 m)
- Light-duty VELOCITY2 Adapter must be ordered separately (1010-1105)
- Conduit Liner – 42 Series

Specifications					
Rated Output	Gas	Wire Size	Cooled	Process	Application Usage
180 A @ 60% duty cycle	CO <sub>2</sub>	up to .045 in. (1.2 mm)	Air	GMAW, AI	light-duty fabrication

Ordering Information					
Tweco Style Rear Connector		Miller Style Rear Connector		Euro-Kwik Style Rear Connector	
12 ft. (3.6 m), .035 in. (0.9 mm)	1010-1115	10 ft. (3 m), .035 in. (0.9 mm)	1010-1125	10 ft. (3 m), .035 in. (0.9 mm)	1010-1147
15 ft. (4.6 m), .035 in. (0.9 mm)	1010-1116	12 ft. (3.6 m), .035 in. (0.9 mm)	1010-1126	12 ft. (3.6 m), .035 in. (0.9 mm)	1010-1148
20 ft. (6.1 m), .035 in. (0.9 mm)	1010-1117	15 ft. (4.6 m), .035 in. (0.9 mm)	1010-1127	15 ft. (4.6 m), .035 in. (0.9 mm)	1010-1149
12 ft. (3.6 m), .045 in. (1.2 mm)	1010-1118	Lincoln Style Rear Connector			
15 ft. (4.6 m), .045 in. (1.2 mm)	1010-1119	15 ft. (4.6 m), .035 in. (0.9 mm)	1010-1138		
20 ft. (6.1 m), .045 in. (1.2 mm)	1010-1120				

MIG GUNS & TIG TORCHES

## Tweco Velocity2 Classic No. 2 200 Amp MIG Gun

Suitable for Medium Duty Fabrication



Standard Options Include:

- Rear Connector and Knucklehead™ Flexible Conductor Tube
- Standard Conductor Tube – (1620-1375) on all guns up to 15 ft. (4.6 m), (1620-1376) on all guns over 15 ft. (4.6 m)
- Conduit Liner – 42 Series

Specifications					
Rated Output	Gas	Wire Size	Cooled	Process	Application Usage
200 A @ 60% duty cycle	CO <sub>2</sub>	up to .045 in. (1.2 mm)	Air	GMAW, AI	medium-duty fabrication

Ordering Information							
Tweco Style Rear Connector		Miller Style Rear Connector		Euro-Kwik Style Rear Connector		Lincoln Style Rear Connector	
10 ft. (3 m), .035 in. (0.9 mm)	1020-1105	10 ft. (3 m), .035 in. (0.9 mm)	1020-1128	12 ft. (3.6 m), .035 in. (0.9 mm)	1020-1305	10 ft. (3 m), .035 in. (0.9 mm)	1020-1147
12 ft. (3.6 m), .035 in. (0.9 mm)	1020-1106	12 ft. (3.6 m), .035 in. (0.9 mm)	1020-1129	10 ft. (3 m), .045 in. (1.2 mm)	1020-1306	12 ft. (3.6 m), .035 in. (0.9 mm)	1020-1148
15 ft. (4.6 m), .035 in. (0.9 mm)	1020-1107	15 ft. (4.6 m), .035 in. (0.9 mm)	1020-1136	12 ft. (3.6 m), .045 in. (1.2 mm)	1020-1307	15 ft. (4.6 m), .035 in. (0.9 mm)	1020-1149
20 ft. (6.1 m), .035 in. (0.9 mm)	1020-1108	10 ft. (3 m), .045 in. (1.2 mm)	1020-1137	15 ft. (4.6 m), .045 in. (1.2 mm)	1020-1308		
25 ft. (7.6 m), .035 in. (0.9 mm)	1020-1109	12 ft. (3.6 m), .045 in. (1.2 mm)	1020-1138				
12 ft. (3.6 m), .045 in. (1.2 mm)	1020-1117	15 ft. (4.6 m), .045 in. (1.2 mm)	1020-1139				
15 ft. (4.6 m), .045 in. (1.2 mm)	1020-1118						
20 ft. (6.1 m), .045 in. (1.2 mm)	1020-1119						

## Tweco Velocity2 Classic No. 3 300 Amp MIG Gun

Suitable for Medium/Heavy Duty Fabrication



Standard Options Include:

- Rear Connector
- Standard Conductor Tube – (1630-1229) on all guns up to 15 ft. (4.6 m), (1630-1230) on all guns over 15 ft. (4.6 m)
- Conduit Liner – 44 Series

Specifications					
Rated Output	Gas	Wire Size	Cooled	Process	Application Usage
300 A @ 60% duty cycle	CO <sub>2</sub>	up to 1/16 in. (1.6 mm)	Air	GMAW, AI	medium/heavy-duty fabrication

Ordering Information					
Tweco Style Rear Connector		Miller Style Rear Connector		Euro-Kwik Style Rear Connector	
10 ft. (3 m), .045 in. (1.2 mm)	1030-1003	10 ft. (3 m), .045 in. (1.2 mm)	1030-1013	10 ft. (3 m), .045 in. (1.2 mm)	1030-1020
12 ft. (3.6 m), .045 in. (1.2 mm)	1030-1004	12 ft. (3.6 m), .045 in. (1.2 mm)	1030-1014	12 ft. (3.6 m), .045 in. (1.2 mm)	1030-1021
15 ft. (4.6 m), .045 in. (1.2 mm)	1030-1005	15 ft. (4.6 m), .045 in. (1.2 mm)	1030-1015	15 ft. (4.6 m), .045 in. (1.2 mm)	1030-1022
20 ft. (6.1 m), .045 in. (1.2 mm)	1030-1006	15 ft. (4.6 m), 1/16 in. (1.6 mm)	1030-1016	15 ft. (4.6 m), 5/64 in. (2.0 mm)	1030-1023
25 ft. (7.6 m), .045 in. (1.2 mm)	1030-1007	<b>Lincoln Style Rear Connector</b>			
12 ft. (3.6 m), 1/16 in. (1.6 mm)	1030-1008	10 ft. (3 m), .045 in. (1.2 mm)	1030-1017		
15 ft. (4.6 m), 1/16 in. (1.6 mm)	1030-1009	12 ft. (3.6 m), .045 in. (1.2 mm)	1030-1018		
25 ft. (7.6 m), 1/16 in. (1.6 mm)	1030-1010	15 ft. (4.6 m), .045 in. (1.2 mm)	1030-1019		

## Tweco Velocity2 Classic No. 4 400 Amp MIG Gun

Suitable for Heavy Duty Fabrication



Standard Options Include:

- Dual Schedule On/Off Control, Rear Connector and Knucklehead™ Flexible Conductor Tube
- Standard Conductor Tube – (1640-1400) on all guns up to 15 ft. (4.6 m), (1640-1401) on all guns over 15 ft. (4.6 m)
- Conduit Liner – 44 Series

Specifications					
Rated Output	Gas	Wire Size	Cooled	Process	Application Usage
400 A @ 60% duty cycle	CO <sub>2</sub>	up to 1/16 in. (1.6 mm)	Air	GMAW, AI, FCAW	heavy-duty fabrication

Ordering Information							
Tweco Style Rear Connector		Miller Style Rear Connector		Euro-Kwik Style Rear Connector		Lincoln Style Rear Connector	
10 ft. (3 m), .045 in. (1.2 mm)	1040-1901	10 ft. (3 m), .045 in. (1.2 mm)	1040-1914	10 ft. (3 m), .045 in. (1.2 mm)	1040-1934	10 ft. (3 m), .045 in. (1.2 mm)	1040-1927
12 ft. (3.6 m), .045 in. (1.2 mm)	1040-1902	12 ft. (3.6 m), .045 in. (1.2 mm)	1040-1915	12 ft. (3.6 m), .045 in. (1.2 mm)	1040-1935	12 ft. (3.6 m), .045 in. (1.2 mm)	1040-1928
15 ft. (4.6 m), .045 in. (1.2 mm)	1040-1903	15 ft. (4.6 m), .045 in. (1.2 mm)	1040-1916	15 ft. (4.6 m), .045 in. (1.2 mm)	1040-1936	15 ft. (4.6 m), .045 in. (1.2 mm)	1040-1929
15 ft. (4.6 m), .045 in. (1.2 mm)	1040-1904	15 ft. (4.6 m), .045 in. (1.2 mm)	1040-1917 <sup>2</sup>	25 ft. (7.6 m), .045 in. (1.2 mm)	1040-1937	15 ft. (4.6 m), .045 in. (1.2 mm)	1040-1930 <sup>2</sup>
15 ft. (4.6 m), .045 in. (1.2 mm)	1040-1905 <sup>2</sup>	20 ft. (6.1 m), .045 in. (1.2 mm)	1040-1918	12 ft. (3.6 m), 1/16 in. (1.6 mm)	1040-1938	12 ft. (3.6 m), 1/16 in. (1.6 mm)	1040-1931
20 ft. (6.1 m), .045 in. (1.2 mm)	1040-1906	25 ft. (7.6 m), .045 in. (1.2 mm)	1040-1919	15 ft. (4.6 m), 1/16 in. (1.6 mm)	1040-1939	15 ft. (4.6 m), 1/16 in. (1.6 mm)	1040-1932
25 ft. (7.6 m), .045 in. (1.2 mm)	1040-1907	10 ft. (3 m), 1/16 in. (1.6 mm)	1040-1920	15 ft. (4.6 m), 5/64 in. (2.0 mm)	1040-1940		
10 ft. (3 m), 1/16 in. (1.6 mm)	1040-1908	12 ft. (3.6 m), 1/16 in. (1.6 mm)	1040-1921				
12 ft. (3.6 m), 1/16 in. (1.6 mm)	1040-1909	15 ft. (4.6 m), 1/16 in. (1.6 mm)	1040-1922				
15 ft. (4.6 m), 1/16 in. (1.6 mm)	1040-1900	20 ft. (6.1 m), 1/16 in. (1.6 mm)	1040-1923				
20 ft. (6.1 m), 1/16 in. (1.6 mm)	1040-1911	25 ft. (7.6 m), 1/16 in. (1.6 mm)	1040-1924				
15 ft. (4.6 m), 5/64 in. (2.0 mm)	1040-1912	15 ft. (4.6 m), 5/64 in. (2.0 mm)	1040-1925				

1 = Dual Schedule  
2 = Knucklehead Conductor Tube – 1640-1113

## Tweco Velocity2 Classic No. 5 500 Amp MIG Gun

Suitable for Heavy Duty Fabrication



Standard Options Include:

- Dual Schedule On/Off Control, Locking Trigger & Rear Connector
- Standard Conductor Tube – (1660-1251) on all guns up to 15 ft. (4.6 m), (1660-1252) on all guns over 15 ft. (4.6 m)
- Conduit Liner – 45 Series

Specifications					
Rated Output	Gas	Wire Size	Cooled	Process	Application Usage
500 A @ 60% duty cycle	CO <sub>2</sub>	up to 3/32 in. (2.4 mm)	Air	GMAW, AI, FCAW	heavy-duty fabrication

Ordering Information			
Tweco Style Rear Connector		Miller Style Rear Connector	
12 ft. (3.6 m), .045 in. (1.2 mm)	1050-1084	15 ft. (4.6 m), 1/16 in. (1.6 mm)	1050-1091
15 ft. (4.6 m), .045 in. (1.2 mm)	1050-1085	15 ft. (4.6 m), 3/32 in. (2.4 mm)	1050-1092
15 ft. (4.6 m), 1/16 in. (1.6 mm)	1050-1086	<b>Lincoln Style Rear Connector</b>	
25 ft. (4.6 m), 1/16 in. (1.6 mm)	1050-1087	15 ft. (4.6 m), 1/16 in. (1.6 mm)	1050-1094
10 ft. (3 m), 3/32 in. (2.4 mm)	1050-1088	<b>Euro-Kwik Style Rear Connector</b>	
15 ft. (4.6 m), 3/32 in. (2.4 mm)	1050-1089	15 ft. (4.6 m), 1/16 in. (1.6 mm)	1050-1096

## Tweco Fusion 180 Amp MIG Gun

Suitable for Light Duty Fabrication



Standard Options Include:

- High Performance Velocity Consumables and Rear Connector
- Conduit Liner – WS42 Series

Specifications					
Rated Output	Gas	Wire Size	Cooled	Process	Application Usage
180 A @ 40% duty cycle	CO <sub>2</sub>	up to .035 in. (0.9 mm)	Air	GMAW, AI	light-duty fabrication
Ordering Information					
Tweco Style (4 Pin) Rear Connector			Miller Style Rear Connector		
12 ft. (3.6 m), .035 in. (0.9 mm)	1017-1331		12 ft. (3.6 m), .035 in. (0.9 mm)	1017-1330	
Tweco Style (8 Pin) Rear Connector			Euro-Kwik Style Rear Connector		
10 ft. (3 m), .035 in. (0.9 mm)	1017-1338		10 ft. (3 m), .035 in. (0.9 mm)	1017-1335	
12 ft. (3.6 m), .035 in. (0.9 mm)	1017-1332		Lincoln Style Rear Connector		
			12 ft. (3.6 m), .035 in. (0.9 mm)	1017-1329	

*Note: Gun length is measured from the front case to the rear case +/-3".*

## Tweco Compact Eliminator 250 Amp MIG Gun

Suitable for Light/Medium Duty Fabrication



Standard Options Include:

- Rear Connector
- Standard Conductor Tube – (1630-1136)
- Conduit Liner – 44 Series

Specifications					
Rated Output	Gas	Wire Size	Cooled	Process	Application Usage
250 A @ 60% duty cycle	CO <sub>2</sub>	up to .045 in. (1.2 mm)	Air	GMAW, AI, FCAW	light/medium-duty fabrication
Ordering Information					
Tweco Style Rear Connector			Miller Style Rear Connector		
12 ft. (3.6 m), .045 in. (1.2 mm)	1028-1108		12 ft. (3.6 m), .045 in. (1.2 mm)	1028-1158	
15 ft. (4.6 m), .045 in. (1.2 mm)	1028-1112		15 ft. (4.6 m), .045 in. (1.2 mm)	1028-1162	
Lincoln Style Rear Connector			25 ft. (7.6 m), .045 in. (1.2 mm)	1028-1170	
15 ft. (4.6 m), .045 in. (1.2 mm)	1028-1186				

MIG GUNS & TIG TORCHES

## Tweco Compact Eliminator 450 Amp MIG Gun

Suitable for Light/Medium Duty Fabrication



Standard Options Include:

- Rear Connector
- Standard Conductor Tube – (1640-1137)
- Conduit Liner – 44 Series

Specifications					
Rated Output	Gas	Wire Size	Cooled	Process	Application Usage
450 A @ 60% duty cycle	CO <sub>2</sub>	up to 1/16 in. (1.6 mm)	Air	GMAW, AI, FCAW	heavy-duty fabrication

Ordering Information					
Tweco® Style Rear Connector		Miller Style Rear Connector		Lincoln Style Rear Connector	
15 ft. (4.6 m), .045 in. (1.2 mm)	1048-1210	10 ft. (3 m), .045 in. (1.2 mm)	1048-1250	15 ft. (4.6 m), .045 in. (1.2 mm)	1048-1285
15 ft. (4.6 m), 1/16 in. (1.6 mm)	1048-1211	12 ft. (3.6 m), .045 in. (1.2 mm)	1048-1255	15 ft. (4.6 m), 1/16 in. (1.6 mm)	1048-1286
20 ft. (6.1 m), 1/16 in. (1.6 mm)	1048-1216	15 ft. (4.6 m), .045 in. (1.2 mm)	1048-1260	Euro-Kwik Style Rear Connector	
25 ft. (7.6 m), 1/16 in. (1.6 mm)	1048-1221	15 ft. (4.6 m), 1/16 in. (1.6 mm)	1048-1261	12 ft. (3.6 m), .045 in. (1.2 mm)	1048-1230
		25 ft. (7.6 m), 1/16 in. (1.6 mm)	1048-1271	15 ft. (4.6 m), .045 in. (1.2 mm)	1048-1235

## Tweco Supra XT SEHD 400 Amp MIG Gun

Suitable for Medium/Heavy Duty Fabrication



Standard Options Include:

- Rear Connector
- Available with Heavy Duty Front End Consumables
- Standard Conductor Tube – (1640-1347) on all guns up to 15 ft. (4.6 m)
- Conduit Liner – 44 Series

Specifications					
Rated Output	Gas	Wire Size	Cooled	Process	Application Usage
400 A @ 60% duty cycle	CO <sub>2</sub>	up to 1/16 in. (1.6 mm)	Air	GMAW, AI, FCAW	medium/heavy-duty fabrication

Ordering Information					
Tweco Style Rear Connector			Euro-Kwik Style Rear Connector		
15 ft. (4.6 m), 1/16 in. (1.6 mm)		1040-1332	15 ft. (4.6 m), 1/16 in. (1.6 mm)		1040-1442
Miller Style Rear Connector			Lincoln Style Rear Connector		
15 ft. (4.6 m), 1/16 in. (1.6 mm)		1040-1342	15 ft. (4.6 m), 1/16 in. (1.6 mm)		1040-1432

## Tweco Velocity2 Supra XT VSEHD 400 Amp MIG Gun

Suitable for Medium/Heavy Duty Fabrication



Standard Options Include:

- Rear connector
- Heavy-duty VELOCITY2 front end consumables
- Standard conductor tubes (1640-1160) on all guns up to 15 ft. (4.6 m), (1640-1161) on all guns over 15 ft. (4.6 m)
- “LM” long reach conductor tubes are available

### Specifications

Rated Output	Gas	Wire Size	Cooled	Process	Application Usage
400 A @ 60% duty cycle	CO <sub>2</sub>	up to .035 in. (0.9 mm)	Air	GMAW, AI, FCAW	medium/heavy-duty fabrication

### Ordering Information

Tweco Style Rear Connector		Lincoln Style Rear Connector	
15 ft. (4.6 m), 1/16 in. (1.6 mm)	1040-1880	15 ft. (4.6 m), 1/16 in. (1.6 mm)	1040-1888
25 ft. (7.6 m), 1/16 in. (1.6 mm)	1040-1881	25 ft. (7.6 m), 1/16 in. (1.6 mm)	1040-1889
15 ft. (4.6 m), 1/16 in. (1.6 mm)	1040-1882*	15 ft. (4.6 m), 1/16 in. (1.6 mm)	1040-1890*
25 ft. (7.6 m), 1/16 in. (1.6 mm)	1040-1883*	25 ft. (7.6 m), 1/16 in. (1.6 mm)	1040-1891*
Euro-Kwik Style Rear Connector		Miller Style Rear Connector	
15 ft. (4.6 m), 1/16 in. (1.6 mm)	1040-1892	15 ft. (4.6 m), 1/16 in. (1.6 mm)	1040-1884
25 ft. (7.6 m), 1/16 in. (1.6 mm)	1040-1893	25 ft. (7.6 m), 1/16 in. (1.6 mm)	1040-1885
15 ft. (4.6 m), 1/16 in. (1.6 mm)	1040-1894*	15 ft. (4.6 m), 1/16 in. (1.6 mm)	1040-1886*
25 ft. (7.6 m), 1/16 in. (1.6 mm)	1040-1895*	25 ft. (7.6 m), 1/16 in. (1.6 mm)	1040-1887*

\*LM - long reach conductor tube.

## Tweco Flux-Cored SEFC 450 Amp MIG Gun

Suitable for Heavy Duty Fabrication



Standard Options Include:

- Rear Connector
- Standard Conductor Tube – (1641-1127) on all guns up to 15 ft. (4.6 m)
- Conduit Liner – 44 Series

### Specifications

Rated Output	Gas	Wire Size	Cooled	Process	Application Usage
450 A @ 60% duty cycle	CO <sub>2</sub>	up to 1/8 in. (3.2 mm)	Air	GMAW, FCAW	heavy-duty fabrication

### Ordering Information

Tweco Style Rear Connector		Miller Style Rear Connector		Lincoln Style Rear Connector	
15 ft. (4.6 m), 3/32 in. (2.5 mm)	1041-1120	15 ft. (4.6 m), 3/32 in. (2.5 mm)	1041-1139	15 ft. (4.6 m), 3/32 in. (2.5 mm)	1041-1113



# TWECO® VELOCITY2™ – LESS DOWNTIME, MORE WELD TIME.

Introducing VELOCITY2, the longest-lasting MIG consumables on the market. These groundbreaking consumables deliver superior welding performance and a better operator experience.



## SPEED AND EFFICIENCY.

The threadless contact tip design eliminates problems with threads, so tip changes take seconds and require no tools.



Updated VELOCITY2 consumables feature a simpler, more robust design. The large copper-to-copper contact surface promotes superior thermal and electrical efficiency. As a result, consumables stay cooler, last longer and produce a smoother arc with reduced spatter. A silicone sleeve over the copper conductor tube minimizes radiant heat and improves impact resistance.

## INNOVATION.

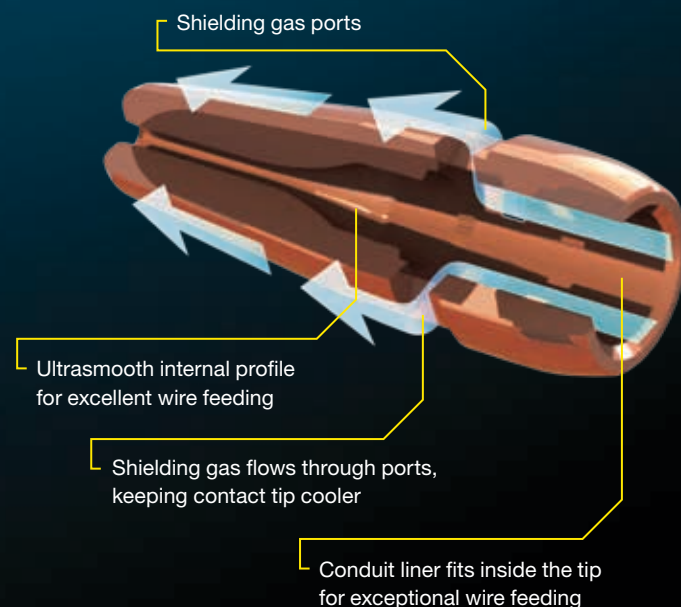
**VELOCITY2**

Learn more at [esab.com](http://esab.com)

## Fusion Pro™ 7W & 9W Water-Cooled MIG Gun

Lightweight Guns for High-Heat Applications



- Lightweight and excellent for high-heat welding applications
- Comfortable, easy to grip, ergonomic handle design
- Adapts with most competitive wire feeders
- Reduced heat increases life of consumables
- Better wire feedability
- Consistent wire feeding even with soft wires
- Thick conductor tube reduces risks of accidental drops

Specifications						
Fusion Pro 7W Rated Output	Fusion Pro 9W Rated Output	Gas	Wire Size	Cooled	Process	Application Usage
450 A @ 100% duty cycle 500 A @ 100% duty cycle	500 A @ 100% duty cycle 550 A @ 100% duty cycle	Mixed Gas CO <sub>2</sub>	.035 - 1/16 in. (1.0 - 1.6 mm )	Water	GMAW, AI	Heavy-Duty Fabrication

Ordering Information		
Description	Part Number	Model Number
7W Water Cooled MIG Gun – 10 ft (3 m) - TWECO	1044-1122	FPW7410116
7W Water Cooled MIG Gun – 12 ft (4 m) - TWECO	1044-1123	FPW7412116
7W Water Cooled MIG Gun – 15 ft (5 m) - TWECO	1044-1124	FPW7415116
9W Water Cooled MIG Gun – 10 ft (3 m) - TWECO	1044-1125	FPW9510116
9W Water Cooled MIG Gun – 12 ft (4 m) - TWECO	1044-1126	FPW9512116
9W Water Cooled MIG Gun – 15 ft (5 m) - TWECO	1044-1127	FPW9515116
7W Water Cooled MIG Gun – 10 ft (3 m) - MILLER	1044-1128	FPW7410M116
7W Water Cooled MIG Gun – 12 ft (4 m) - MILLER	1044-1129	FPW7412M116
7W Water Cooled MIG Gun – 15 ft (5 m) - MILLER	1044-1130	FPW7415M116
9W Water Cooled MIG Gun – 10 ft (3 m) - MILLER	1044-1131	FPW9510M116
9W Water Cooled MIG Gun – 12 ft (4 m) - MILLER	1044-1132	FPW9512M116
9W Water Cooled MIG Gun – 15 ft (5 m) - MILLER	1044-1133	FPW9515M116
7W Water Cooled MIG Gun – 10 ft (3 m) - EURO	1044-1134	FPW7410X116
7W Water Cooled MIG Gun – 12 ft (4 m) - EURO	1044-1135	FPW7412X116
7W Water Cooled MIG Gun – 15 ft (5 m) - EURO	1044-1136	FPW7415X116
9W Water Cooled MIG Gun – 10 ft (3 m) - EURO	1044-1137	FPW9510X116
9W Water Cooled MIG Gun – 12 ft (4 m) - EURO	1044-1138	FPW9512X116
9W Water Cooled MIG Gun – 15 ft (5 m) - EURO	1044-1139	FPW9515X116

MIG GUNS & TIG TORCHES

# PullMaster2™ Air-Cooled MIG Gun

## Push-Pull MIG Gun



- Push-Pull (PP) system is designed to ensure optimal ergonomics for various applications
- Welding torches come with remote capability to set programs and parameter adjustments
- Easy to repair and maintain, durable, tougher material to withstand a heavy industrial environment
- Comfortable easy to grip ergonomic handle design and improved ball & socket style strain relief
- Tweco 16 APS standard and Velocity front end wears
- Comes standard with 30 degree conductor tube, optional 180 degree and flexible knucklehead conductor tubes

### Specifications

Rated Output	Gas	Wire Size (Aluminum)	Cooled	Process	Application Usage
300 A @ 60% duty cycle	Mixed Gas	035 – .052 in. (0.8 – 1.3 mm )	Air	GMAW	Heavy-Duty Fabrication

### Ordering Information

Description	Part Number	Model Number
PullMaster2 Smart PP MIG Gun Assembly 33 ft (10 m)	1027-1417	PMS3333545
PullMaster2 Smart PP MIG Gun Assembly 20 ft (6 m)	1027-1418	PMS3203545
PullMaster2 Standard PP MIG Gun Assembly 33 ft (10 m)	1027-1419	PM3333545
PullMaster2 Standard PP MIG Gun Assembly 20 ft (6 m)	1027-1420	PM3203545

### Ordering Information

Description	Model Number	Part Number	Description	Model Number	Part Number
Teflon Jump Liner f/Flex Tube	PM44FLX116	1644-1091	Contact Tip 1.04 mm (.041 in.) for wire size 0.9 mm (.035 in.)	16PS-35	1160-1535
Teflon Jump Liner f/Rigid Tube 30 deg and 180 deg	PM44PTF116	1644-1092	Contact Tip 1.30 mm (.051 in) for wire size 1.2 mm (.045 in.)	16PS-45	1160-1537
Bronze Jump Liner f/Rigid Tube (for Steel Wires)	PM44116	1644-1093	Contact Tip 1.63 mm (.064 in.) for wire size 1.2 mm (.047 in.)	16APS-364	1160-1538
10 m/33 ft Conduit Liner Assy. for 1.2 – 1.6 mm (3/64 - 1/16 in.) wire	PM11633	1441-1144	Contact Tip 1.50 mm (.058 in.) for wire size 1.3 mm (.052 in.)	16PS-52	1160-1541
6 m /20 ft Conduit Liner Assy. for 1.2 – 1.6 mm (3/64 - 1/16 in.) wire	PM11620	1441-1145	Nozzle, Straight, Thread-On, Flush, 12.7 mm (1/2 in.)	PMA24-50F	1260-1710
Knurled Drive Roll	EPG103212SKS	2031-2097	Nozzle, Straight, Thread-On, Recessed, 12.7 mm (1/2 in.)	PMA24-50	1260-1711
Cablehoz. assembly 10 m (33 ft)	PM30033	2060-2764	Nozzle, Straight, Thread-On, Flush, 15.9 mm (5/8 in.)	PMA24-62F	1260-1712
Cablehoz. assembly 6 m (20 ft)	PM30020	2060-2765	Nozzle, Straight, Thread-On, Recessed, 15.9 mm (5/8 in.)	PMA24-62	1260-1713
Conductor Tube 30 degree	PMP64EL-30	1642-1141	Nozzle, Straight, Thread-On, Recessed HD, 15.9 mm (5/8 in.)	PMA24H-62	1260-1720
Conductor Tube 180 degree	PMP64EL-180	1642-1140	Nozzle, Straight, Thread-On, Flush, 19.5 mm (3/4 in.)	PMA24-75F	1260-1714
Conductor Tube, Flex Knucklehead™	PMP64SFLX-360	1642-1142	Nozzle, Straight, Thread-On, Recessed, 19.5 mm (3/4 in.)	PMA24-75	1260-1715
Diffuser	PMA54-16S	1543-1106	Nozzle, Straight, Thread-On, Recessed HD, 19.5 mm (3/4 in.)	PMA24H-75	1260-1721

## MXH 315 PP Air-Cooled MIG Gun

Push-Pull System with great feeding performance



- Designed to ensure optimal ergonomics for various applications
- MXH Push-Pull (PP) welding torches quickly change between straight conductor tube 0° or 45° rotatable conductor tube
- Compatible with most competitive power source/feeder systems, in combination with the Syntronic 3 synchronization device
- Easy wear part system – same rolls for most applications (only AISi wires require wear part change)
- Plug'n'play with Robust Feed U6 (see connection kit section for more details) and 3004 feeder systems using MXH adapters
- Well balanced easy to grip handle to avoid fatigue during hours of use in wide fields of applications
- Stable arc due to the consistent wire feeding even of soft wires

Specifications					
Welding Output*	Gas	Wire Size	Cooled	Process	Application Usage
270 A @ 60% duty cycle 310 A @ 60% duty cycle	Mixed Gas CO <sub>2</sub>	.035 - 1/16 in. (0.8 - 1.6 mm )	Air	GMAW	Heavy-Duty Fabrication

\*The maximum welding current depends on the torch version used, please refer to the type plate on the machine side connector of the torch for applicable data.

Ordering Information		
Description	Part Number	Model Number
Push Pull Air-Cooled MIG Gun – 20 ft (6 m) - EURO	1027-1421	PPMXH315X203545
Push Pull Air-Cooled MIG Gun – 20 ft (6 m) - TWECO	1027-1422	PPMXH315203545
Push Pull Air-Cooled MIG Gun – 20 ft (6 m) - MILLER	1027-1423	PPMXH315M203545
Push Pull Air-Cooled MIG Gun – 33 ft (10 m) - EURO	1027-1424	PPMXH315X333545
Push Pull Air-Cooled MIG Gun – 33 ft (10 m) - TWECO	1027-1425	PPMXH315333545
Push Pull Air-Cooled MIG Gun – 33 ft (10 m) - MILLER	1027-1426	PPMXH315M333545

## MXH 420W PP Water-Cooled MIG Gun

Push-Pull System with great feeding performance



- Designed to ensure optimal ergonomics for various applications and is robust enough for high duty cycle weld applications
- MXH Push-Pull (PP) welding torches quickly change between straight conductor tube 180° or 45° rotatable conductor tube
- Developed with focus on consistent wire feeding – particularly for challenging welding needs with soft and smaller diameter wires
- Easy wear part system – same rolls for most applications (only AISi wires require wear part change)
- Plug'n'play with Robust Feed U6 (see connection kit section for more details) and 3004 feeder systems using MXH adapters
- Well balanced easy to grip handle to avoid fatigue during hours of use in wide fields of applications

Specifications					
Welding Output*	Gas	Wire Size	Cooled	Process	Application Usage
270 A @ 60% duty cycle 310 A @ 60% duty cycle	Mixed Gas CO <sub>2</sub>	.035 - 1/16 in. (0.8 - 1.6 mm )	Air	GMAW	Heavy-Duty Fabrication

\*The maximum welding current depends on the torch version used, please refer to the type plate on the machine side connector of the torch for applicable data.

Ordering Information		
Description	Part Number	Model Number
Push Pull Water-Cooled MIG Gun – 20 ft (6 m) - EURO	1044-1141	PPMXH420WX203545
Push Pull Water-Cooled MIG Gun – 20 ft (6 m) - TWECO	1044-1142	PPMXH420W203545
Push Pull Water-Cooled MIG Gun – 20 ft (6 m) - MILLER	1044-1143	PPMHX420WM203545
Push Pull Water-Cooled MIG Gun – 33 ft (10 m) - EURO	1044-1144	PPMXH4420WX333545
Push Pull Water-Cooled MIG Gun – 33 ft (10 m) - TWECO	1044-1145	PPMXH420W333545
Push Pull Water-Cooled MIG Gun – 33 ft (10 m) - MILLER	1044-1146	PPMXH420WM333545

## Tweco Standard 600 Amp Water-Cooled MIG Gun

Suitable for Heavy Duty Fabrication



Standard Options Include:

- Rear Connector
- Standard Conductor Tube – (1664-1106)
- Conduit Liner – 45 Series
- Ergonomic Handle
- Low Bench Weight for easy to handle gun
- Cooling benefits
- Large water lines, threaded water line connections and high water flow rates

### Specifications

Rated Output	Gas	Wire Size	Cooled	Process	Application Usage
600 A @ 100% duty cycle	CO <sub>2</sub>	up to 7/64 in. (2.8 mm)	Water	GMAW, AI	heavy-duty fabrication

### Ordering Information

Tweco Style Rear Connector - Smart			
10 ft. (3 m), 1/16 in. (1.6 mm)	1064-1114	15 ft. (4.6 m), 1/16 in. (1.6 mm)	1064-1116
15 ft. (4.6 m), .045 in. (1.2 mm)	1064-1106		

Adapter kits are available to fit Tweco rear connection to most wire feeders.

## ESAB ST Water-Cooled MIG Guns

Suitable for Medium/Heavy Duty Fabrication



- Rated at 600A with any shielding gas
- Handles flux cored wires to 7/64 in. (2.8 mm)
- ST-21M has an in-line body style designed for mechanized applications



### Specifications

	ST-16	ST-21	ST-21M
Gun capacity	600A @ 100% duty cycle	600A @ 100% duty cycle	600A @ 100% duty cycle
Dimensions, LxH	13-3/4 x 4-1/4 in. (350 x 110 mm)	12-1/2x7-1/16 (315x180)	10.25 (260) (length only)
Handle diameter)	1-3/8 in. (35 mm)	1-3/8 in. (35 mm)	1-3/8 (35)
Gun angle	55°	180°	180°
Weight, (less service lines)	28 oz. (794 g)	38 oz. (1077 g)	28 (794)
Cooling requirements	1.6 qt/min (1.5 L/min) minimum	1.6 qt/min (1.5 L/min) minimum	1.6 qt/min (1.5 L/min) minimum
Wires accommodated:			
Hard	.030-3/32 in. (0.8-2.4 mm)	.030-3/32 in. (0.8-2.4 mm)	.030-3/32 in. (0.8-2.4 mm)
Soft	.035-3/32 in. (0.9-2.4 mm)	.035-3/32 in. (0.9-2.4 mm)	.035-3/32 in. (0.9-2.4 mm)
Cored	.030-7/64 in. (0.8-2.8 mm)	.030-7/64 in. (0.8-2.8 mm)	.030-7/64 in. (0.8-2.8 mm)

### Ordering Information

ST-16, 10 ft. (3 m)	997498
ST-21, 12 ft. (3.6 m)	995950
ST-21M, 2 ft. (0.6 m)	690509

Does not include liner/conduits, contact tips/tubes or nozzles.

## Tweco Spool Guns

Suitable for Light/Medium Duty Fabrication



Standard Options Include:

- 8-pin Amphenol Style Connector
- Standard Straight (180°) Conductor Tube
- Holds standard 4" (102 mm) diameter spools
- Optional 30° Rigid Conductor Tube or Knucklehead Flexible Conductor Tube
- Use for aluminum, stainless steel and mild steel applications
- Comfortable pistol-grip handle design
- Three-layer conductor tube construction
- 3-turn potentiometer

Specifications - Light-Duty 160 Amp					
Rated Output	Gas	Wire Size	Cooled	Process	Application Usage
180 A @ 20% duty cycle	Mixed	up to .035 in. (0.9 mm)	Air	GMAW, AI	light-duty fabrication

Specifications - Medium-Duty 200 Amp					
Rated Output	Gas	Wire Size	Cooled	Process	Application Usage
200 A @ 60% duty cycle	Mixed	up to .045 in. (1.2 mm)	Air	GMAW, AI	medium-duty fabrication

Ordering Information					
Tweco Style Rear Connector					
160 Amp - 12 ft. (3.6 m), .035 in. (0.9 mm) (Thermal Arc)	1027-1390	160 Amp - 12 ft. (3.6 m), .035 in. (0.9 mm) (Rebel)	1027-1397		
200 Amp - 12 ft. (3.6 m), .045 in. (1.2 mm)	1027-1398	200 Amp - 25 ft. (7.6 m), .045 in. (1.2 mm) (standard offering with 4-pin)	1027-1392		
200 Amp - 25 ft. (7.6 m), .045 in. (1.2 mm) (Rebel)	1027-1399	200 Amp - 25 ft. (7.6 m), .045 in. (1.2 mm) (Thermal Arc)	1027-1391		

## ESAB ST-23A Spool Gun

Suitable for Medium/Heavy Duty Fabrication



- Service lines enter the rear of gun instead of handle for improved balance and accessibility
- Inching push button mounted on bottom of handle
- 30 ft. (9 m) service lines
- Uses durable contact tips and nozzles
- Powerful gear motor in handle pulls welding wire from 4 in. (101.5 mm) diameter spool in the molded gun case
- Partial depression of the torch trigger controls gas pre- and post-flow operations - full depression provides wire feeding as well as gas flow
- Wire feed control mounted on gun provides precise adjustment of wire feed rate at torch

Specifications					
Rated Output	Gas	Wire Size	Cooled	Process	Application Usage
250 A @ 100% duty cycle	Mixed	up to 1/16 in. (1.6 mm)	Air	GMAW, AI	medium/heavy-duty fabrication

Ordering Information	
ST-23A Spool Gun	19164

Includes: one 3/64 in. (1.2 mm) contact tip, drive roll, liner, control cable, gas hose and #10 nozzle and 30 ft. (9 m) service lines.

## Tweco® Centrovac Fume Extraction MIG Guns

Air- & Water-Cooled Fume Extraction MIG Guns



- Designed to extract a large volume of fumes at the weld source for light-, medium- and heavy-duty applications
- Removes the smoke cloud to minimize downtime and maximize production uptime by increasing the welder's visibility and efficiency
- Improves work conditions and provides a healthier environment for the welder and coworkers
- Back end design available in multiple connections and adapts to most competitive wire feeders, preventing fumes from reaching the power connection and resulting in less maintenance
- Over 95% of fumes can be removed when using the correct extraction system for the weld application
- Vacuum vent located at the front of the handle allows user to easily adjust extraction rates and help eliminate the possibility of extracting too much shielding gas in tight areas
- Light, well-balanced and ergonomic handle design makes it very comfortable to grip with exceptional articulate motion using a knuckle joint configuration

Specifications	Tweco 260C	Tweco 415C	Tweco 420Cw
<b>Cooling</b>	Air-Cooled	Air-Cooled	Water-Cooled*
<b>Welding Output CO<sub>2</sub>**</b>	250 A at 60% duty cycle	380 A at 60% duty cycle	430 A at 100% duty cycle
<b>Welding Output Mixed Gas***</b>	225 A at 60% duty cycle	325 A at 60% duty cycle	430 A at 100% duty cycle
<b>Recommended Gas Flow</b>	8-12 l/min (17-25 cfh)	10-18 l/min (22-38 cfh)	10-20 l/min (22-42 cfh)
<b>Wire Diameter</b>	.024 in.-.039 in. (0.6-1.0 mm)	.035 in.-1/16 in. (0.8-1.6 mm)	.039 in.-1/16 in. (1.0-1.6 mm)
<b>Certification Mark (Standards)</b>	IEC/EN 60974-7		
<b>Operating Temperature</b>	-10 °C to 40 °C (14 °F -104 °F)		
<b>Cable Length</b>	10 ft (3 m), 15 ft (5 m)***		

\*When using liquid cooled torches in freezing conditions, use an adequate cooling liquid.

\*\*Rated using power source with VDE standard volt/amp characteristic ( $U=14+0.05xI$ ). When pulse welding, reduce rating by 35%.

\*\*\*Upon a special request, a 12ft. long Tweco Fume MIG Gun can be ordered.

### Ordering Information

Description	Cooling	10 ft (3 m)		15 ft (5 m)	
		Model Number	Part Number	Model Number	Part Number
Tweco 260C - TWECO	Gas	S260C104045	1026-1108	S260C154045	1026-1110
Tweco 260C - MILLER		S260CM104045	1026-1111	S260CM154045	1026-1113
Tweco 260C - EURO		S260CX104045	1026-1114	S260CX154045	1026-1116
Tweco 415C - TWECO	Gas	S415C104045	1026-1117	S415C154045	1026-1119
Tweco 415C - MILLER		S415CM104045	1026-1120	S415CM154045	1026-1122
Tweco 415C - EURO		S415CX104045	1026-1128	S415CX154045	1026-1130
Tweco 420Cw - TWECO	Water	S420W104045	1026-1133	S420W154045	1026-1135
Tweco 420Cw - MILLER		S420WM104045	1026-1136	S420WM154045	1026-1138
Tweco 420Cw - EURO		S420WX104045	1026-1139	S420WX154045	1026-1141

For wear & spare parts please see separate fact sheet or instruction manual.



## SR-B Family

### Multi-Functional and Ergonomic TIG Welding Torches



- SR-B torches are dedicated to quality and designed to provide convenience and versatility.
- Choose between air-cooled or water-cooled, with or without gas-valve and with optional flexible head to suit your individual application
- Ergonomically formed handle with toggle switch
- Cable assembly with swivel cable support on the handle

Specifications								
	SR-B 9	SR-B 17	SR-B 18	SR-B 20	SR-B 21	SR-B 26	SR-B 26 HD	SR-B 400
<b>Welding Output (10 min)</b>	60% 80 A AC 110 A DC	60% 100 A AC 140 A DC	100% 225 A AC 320 A DC	100% 160 A AC 220 A DC	100% 240 A AC 340 A DC	60% 140 A AC 200 A DC	60% 160 A AC 230 A DC	100% 315 A AC 450 A DC
<b>Electrode Ø</b>	0.5-1.6 mm	0.5-2.4 mm	0.5-4.0 mm	0.5-3.2 mm	0.5-3.2 mm	0.5-4.0 mm	0.5-4.0 mm	1.0-4.8 mm
<b>Cooling</b>	Air-Cooled	Air-Cooled	Water-Cooled	Water-Cooled	Water-Cooled	Air-Cooled	Air-Cooled	Water-Cooled

Specifications							
Torch	Cooling	OKC 25		OKC 50, 2-pin amphenol plug			
		4 m	8 m	4 m	8 m	12 m	16 m
SR-B 9	Gas-Cooled			0700025500	0700025501		
SR-B 9-R	Gas-Cooled			0700025559			
SR-B 9FX	Gas-Cooled			0700025506	0700025507		
SR-B 9FX-R	Gas-Cooled				0700025562		
SR-B 9V	Gas-Cooled	0700025504	0700025505				
SR-B 17	Gas-Cooled			0700025508	0700025509	0700025510	0700025511
SR-B 17-R	Gas-Cooled			0700025563	0700025564		
SR-B 17FX	Gas-Cooled			0700025516	0700025517		
SR-B 17V	Gas-Cooled	0700025512	0700025513	0700025514	0700025515		
SR-B 26	Gas-Cooled			0700025518	0700025519	0700025520	0700025521
SR-B 26-R	Gas-Cooled			0700025567	0700025568		
SR-B 26FX	Gas-Cooled			0700025524	0700025525		
SR-B 26FX-R	Gas-Cooled			0700025569	0700025570		
SR-B 26HD	Gas-Cooled			0700025526	0700025527		
SR-B 26V	Gas-Cooled			0700025522	0700025523		
SR-B 26V HD	Gas-Cooled			0700025530	0700025531		
SR-B 26 FX HD	Gas-Cooled			0700025532	0700025533		
SR-B 18	Water-Cooled			0700025550	0700025551		
SR-B 18FX	Water-Cooled			0700025554	0700025555		
SR-B 20	Water-Cooled			0700025534	0700025535		
SR-B 20FX	Water-Cooled			0700025536	0700025537		
SR-B 21	Water-Cooled			0700025544	0700025545	0700025546	0700025547
SR-B 21-R	Water-Cooled			0700025571	0700025572		
SR-B 21FX	Water-Cooled			0700025548	0700025549		0700025558
SR-B 21FX-R	Water-Cooled			0700025573	0700025574		
SR-B 400	Water-Cooled			0700025538	0700025539		
SR-B 400 R	Water-Cooled			0700025575	0700025576		

FX = Flexible head, V = Valve, HD = Heavy Duty, R = Remote

## Remote Controls



### MTA1 CAN

- CAN based remote control for control panels A2, A4, T4, T6, M2, MA4, MA6, U6, and Aristo U8<sub>2</sub> Plus

Ordering Information	
MTA1 CAN	0459491880



### M1

- Analogue standard MIG for control panels M10, M12, M13, M13i, M14 and Warrior Feed
- Stick/TIG: Wire feed and voltage control

Ordering Information	
M1	0459491895



### M1 10Prog CAN

- CAN based Synergic MIG for control panels MA6, U6 and AristoPendant U8<sub>2</sub> Plus
- Stick/TIG: Memory 1-10 and voltage trim =/-

Ordering Information	
M1 10Prog CAN	0459491882



### AT1 Coarse

- Analogue standard Stick and TIG for power sources with remote outlet – Warrior 400i MV/500i
- Stick/TIG: Current control

Ordering Information	
AT1 Coarse	0459491896



### AT1 CAN

- CAN based standard Stick and TIG for control panels A2, A4, T4, T6, U6, U8<sub>2</sub> Plus
- Stick/TIG: Current control

Ordering Information	
AT1 CAN	0459491883



### AT1 Coarse/Fine

- Analogue standard Stick and TIG for power sources with remote outlet – Warrior 400i MV/500i
- Stick/TIG: Current control, coarse/fine

Ordering Information	
AT1 Coarse/Fine	0459491897



### AT1 Coarse/Fine CAN

- CAN based standard Stick and TIG for control panels A2, A4, T4, T6, U6, U8<sub>2</sub> Plus
- Stick/TIG: Current control, coarse/fine

Ordering Information	
AT1 Coarse/Fine CAN	0459491884



### Remote Adapters for CAN Based Systems

- For analog Stick and TIG remote controls. For analog MIG remote controls and 3-step program switch RS3

Ordering Information	
RA 12 for Stick and TIG	0459491910
RA T1 TIG remote torch 12 pole <sup>1</sup>	0459491912
RA T1 TIG remote torch 10 pole <sup>1</sup>	0459491913

<sup>1</sup>Includes holder and cable.

## Remote Controls



### Foot Control - GTAW

- Complete with 16.5 ft (5 m) rubber cable and equipped with 12-pole Burndy

#### Ordering Information

FS003-B analog remote 25 ft. (7.6 m)	0558008905
--------------------------------------	------------



### Remote Control MMA1

- MMA 1 is equipped with 1 potentiometers for current setting
- Includes 33 ft. (10 m) rubber cable equipped with a 12-pole Burndy and a metal hook

#### Ordering Information

MMA1	0349501024
------	------------

#### Ordering Information

##### Additional Remote Controls

HC-3B hand pendant control (cc-Amps/cv-Volts)	33838
TC-2B torch control	33839
FC-5C foot control	0558004234
FC-5B EHD foot control	33841

## Twist Lock Connectors

#### Ordering Information

##### OKC50 Connectors [2 in. (50 mm)]

Male for 1/0 to 4/0 cable	13792513
Female for 1/0 to 4/0 cable	13735631
Male for #2 AWG to 1/0 cable	13733936
Female for #2 AWG to 1/0 cable	13735632
Quick connector with 1/2 in. threaded stud	13735501
Tee connector (1 male, 2 female)	13792804

## Interconnection Cables

#### Ordering Information

##### 10 Pole

0.8 ft. (0.25 m)	0459960883
16.4 ft. (5 m)	0459960880
33 ft. (10 m)	0459960881
82 ft. (25 m)	0459960882
16.4 ft. (5 m) HD	0459960880
33 ft. (10 m) HD	0459960881
82 ft. (25 m) HD	0459960882

##### 12 Pole

0.8 ft. (0.25 m) CAN	0459554884
16.4 ft. (5 m) CAN	0459554880
33 ft. (10 m)	0459554881
49 ft. (15 m) CAN	0459554882
66 ft. (20 m) CAN	0459554883
16.4 ft. (5 m) ANALOG 23 p	0459553880
16.4 ft. (5 m) ANALOG 12 p	0459552880
33 ft. (10 m) ANALOG 12 p	0459552881
49 ft. (15 m) ANALOG 12 p	0459552882
82 ft. (25 m) ANALOG 12 p	0459552883

## Electrode Holders



A-316

A-732

A-14

### TwecoTong A-Series

- TwecoTong Electrode Holders are designed to mechanically hold a welding electrode in position
- Reversible Top & Bottom Insulators are easy to replace
- Efficient 6-Position Jaw Patterns
- Ball Point Cable Connections
- Fully Insulated & Protected Springs
- Heavy Duty Copper Alloy

### Ordering Information

Amperage	Body Alloy	Electrode	Cable	Length	Stock No.
200	Copper Alloy	5/32" (4.0 mm)	2/0 (67.4 mm)	8-1/2" (216 mm)	9110-1101
200	Copper Alloy	5/32" (4.0 mm)	2/0 (67.4 mm)	8-1/2" (216 mm)	9110-1109
250	Copper Alloy	3/16" (4.8 mm)	2/0 (67.4 mm)	9-1/4" (235 mm)	9110-1102
250	Copper Alloy	3/16" (4.8 mm)	2/0 (67.4 mm)	9-1/4" (235 mm)	9110-1110
300	Copper Alloy	7/32" (5.6 mm)	2/0 (67.4 mm)	10" (254 mm)	9110-1103
300	Copper Alloy	7/32" (5.6 mm)	2/0 (67.4 mm)	10" (254 mm)	9110-1111
350	Copper Alloy	1/4" (6.4 mm)	4/0 (107 mm)	11" (279 mm)	9110-1104
400	Copper Alloy	1/4" (6.4 mm)	4/0 (107 mm)	12" (305 mm)	9110-1105
500	Copper Alloy	3/8" (9.5 mm)	4/0 (107 mm)	13-1/4" (336 mm)	9110-1106

\* Clamshell packaging. Sold individually or master packed in quantities of 12 each.

\*\* Sold in Master Pack Boxed Quantities of 24.



T-532

T-316

T-732

### TwecoTong T-Series

- Ergonomic Handle has 12-degree angle
- Efficient 6-Position Jaw Patterns to hold the welding electrode in position
- Double Ball Point Cable Connections accept up to 2/0 welding cable
- Rugged & Reliable Design with operator appeal
- Designed to meet IEC 60974-11
- Fully Insulated & Protected Springs

### Ordering Information

Amperage	Body Alloy	Electrode	Cable	Length	Stock No.
200	Copper Alloy	5/32" (4.0 mm)	2/0 (67.4 mm)	9-1/2" (241 mm)	9110-1122
200	Copper Alloy	5/32" (4.0 mm)	2/0 (67.4 mm)	9-1/2" (241 mm)	9110-1131
250	Copper Alloy	3/16" (4.8 mm)	2/0 (67.4 mm)	9-1/2" (241 mm)	9110-1123
250	Copper Alloy	3/16" (4.8 mm)	2/0 (67.4 mm)	9-1/2" (241 mm)	9110-1132
300	Copper Alloy	7/32" (5.6 mm)	2/0 (67.4 mm)	10" (254 mm)	9110-1124
300	Copper Alloy	7/32" (5.6 mm)	2/0 (67.4 mm)	10" (254 mm)	9110-1133

\* Sold in Master Pack Boxed Quantities of 24. \*\* Sold Individually.



4TT

### TwecoTite

- Tweco-Tite Electrode Holders with Fully Insulated Body designed for effortless installation of electrodes
- 45 Degree Angled Head holds the welding electrode in place

### Ordering Information

Amperage	Electrode	Cable	Stock No.
400	1/4" (6.4 mm)	4/0 (107 mm)	9110-1105

# Ground Clamps

EASY FIND GUIDE											
	Application	Amperage Range								Recommended Model	
		200	300	400	500	600	700	800	1500		2000
Ground Clamps	Plate										FGC 200
											FGC 300
											FGC 500
											SGC 300
											SGC 500
	Pipe										GC 200
											GC 300
											GC 500
											SMGC 200
											SMGC 300
	Rotary										SMGC 600
											GCRG 140
											RG 140
											RG 230
											RG 240
										RG 440	
										RG 640	

Model	Output			Cable Connection	Process			Application			
	Current (Amps)	Jaw Opening	No. of Heads		Plate	Pipe	Rotary	Light Duty Fab	Med. Duty Fab	Heavy Duty Fab	Extra Heavy Duty Fab
FGC 200	200	2" (50.8 mm)	--	Ball-Point thru 1/0	■			■			
FGC 300	300	3-1/2" (88.9 mm)	--	Ball-Point thru 3/0	■			■	■		
FGC 500	500	3-3/4" (95.3 mm)	--	Ball-Point thru 4/0	■				■	■	
SGC 300	300	2" (50.8 mm)	--	1/2" Stud	■			■	■		
SGC 500	500	2" (50.8 mm)	--	1/2" Stud	■				■	■	
GC 200	200	3" (76.2 mm)	--	Ball-Point thru 1/0		■		■			
GC 300	300	4" (101.0 mm)	--	Ball-Point thru 3/0		■		■	■		
GC 500	500	5-1/4" (133.0 mm)	--	Ball-Point thru 4/0		■			■	■	
SMGC 200	200	--	--	Ball-Point thru 1/0		■		■			
SMGC 300	300	--	--	Ball-Point thru 3/0		■		■	■		
SMGC 600	600	--	--	Ball-Point thru 4/0		■				■	
GCRG 140	400	--	1	1 thru 4/0			■		■	■	
RG 140	400	--	1	1 thru 4/0			■		■	■	
RG 230	600	--	1	2 thru 3/0			■			■	
RG 240	800	--	1	2 thru 4/0			■			■	■
RG 440	1500	--	2	4 thru 4/0			■				■
RG 640	2000	--	3	6 thru 4/0			■				■

ARC  
ACCESSORIES

## Ground Clamps

Ideal for most Light to Medium Duty fabrication needs

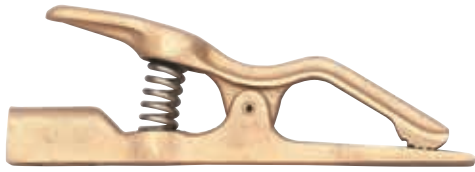

Flat Jaw Copper Ground Clamps

- Ideal for plate grounding

### Ordering Information

Amperage	Jaw Opening	Cable	Length	Stock No.
200	5/8" - Depth 2" (15.9 mm - 50.8 mm)	Ball-Point thru 1/0	5" (127 mm)	9205-1320
300	1" - Depth 3-1/2" (25.4 mm - 88.9 mm)	Ball-Point thru 3/0	7-14" (184 mm)	9205-1330
500	1-1/4" - Depth 3-3/4" (31.8 mm - 95.3 mm)	Ball-Point thru 4/0	9-1/4" (234 mm)	9205-1350



Steel Ground Clamps

- Ideal for plate grounding and lower amperage needs

### Ordering Information

Amperage	Jaw Opening	Cable	Length	Stock No.
300	2" - Depth 1-3/4" (50.8 mm - 44.4 mm)	1/2" Stud Connection	9" (228 mm)	9205-1230
500	2" - Depth 1-3/4" (50.8 mm - 44.4 mm)	1/2" Stud Connection	9" (228 mm)	9205-1250



Copper Ground Clamps

- Ideal for pipe grounding

### Ordering Information

Amperage	Jaw Opening	Cable	Length	Stock No.
200	1" - Depth 3" (25.4 mm - 76.2 mm)	Ball-Point thru 1/0	6" (157 mm)	9205-1120
300	1-1/2" - Depth 4" (38.1 mm - 101.0 mm)	Ball-Point thru 3/0	8-1/2" (216 mm)	9205-1130
300	2" - Depth 1-3/4" (50.8 mm - 44.4 mm)	Ball-Point thru 3/0	8-1/2" (216 mm)	9205-1131
500	2" - Depth 1-3/4" (50.8 mm - 44.4 mm)	Ball-Point thru 4/0	10" (254 mm)	9205-1150

## Ground Clamps

Ideal for most heavy-duty fabrication needs

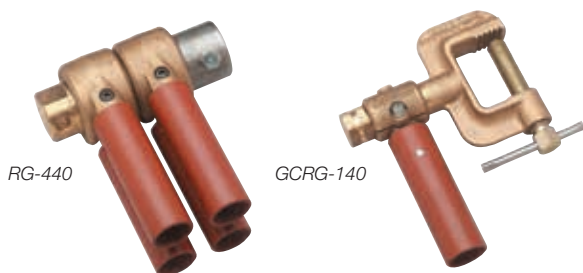

### Tweco Roto-Ground Clamps

- Ideal for high amperage grounding
- Highly efficient device for grounding weldments while being rotated on turning rolls or positioners
- The 2" shaft shoulders up to a steel nut which the user welds to the rotating work or fixture
- Tweco Roto-Grounds have no brushes, springs or mercury
- A simple tension adjusting bolt provides maximum efficiency

Ordering Information					
Amperage	Cable	Number of Heads	Shaft Stud	Length	Stock No.
400	1 - 4/0	1	3/4" NC	--	9210-1314
400	1 - 4/0	1	3/4" NC	8" (203 mm)	9250-1114
600	2 - 3/0	1	1-1/8" NC	10-1/4" (260 mm)	9250-1123
800	2 - 4/0	1	1-3/8" NC	10-5/8" (270 mm)	9250-1124
1500	4 - 4/0	2	1-3/8" NC	10-5/8" (270 mm)	9250-1144
2000	6 - 4/0	3	1-3/8" NC	10-5/8" (270 mm)	9250-1164

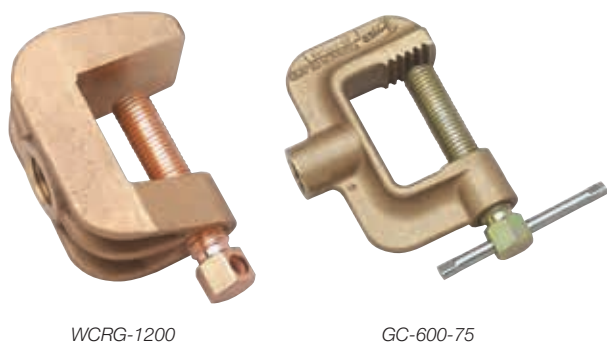

### Tweco Roto-Work Clamps

- Tweco Roto-Work Ground Clamps are designed primarily to work in conjunction with the Tweco Roto-Ground Device, however they may also be used for other high amperage grounding applications
- The Roto-Ground shaft screws into the tapped back of the Roto-Work Clamp
- The clamp is quickly attached or moved from one rotation weldment or fixture to the other without removing the Roto-Ground from it, saving on welding down time
- Roto-Work Clamps are made from a copper alloy
- They come in 600, 1200 and 2000 ampere capacity
- Number WCRG-2000 has two tightening screws
- Number WCRG-600 works only with No. RG-230 due to its smaller shaft size
- Large tightening screws and ample contact surface area provide cool, efficient operation

Ordering Information - Tweco Roto-Work Ground Clamps								
Amperage	Fits Roto-Ground	Clamp Contact	Throat Height	Throat Depth	Overall Height	Overall Width	Tapped For	Stock No.
600	RG-230	6-1/4 sq in	2-1/2" (63.5 mm)	2-1/2" (63.5 mm)	5-3/4" (146.0 mm)	2-1/2" (63.5 mm)	1-1/8" NC	9255-1106
1200	RG-240/440	9 sq in	3" (76.2 mm)	3" (76.2 mm)	6-3/4" (171.0 mm)	3" (76.2 mm)	1-3/8" NC	9255-1112
2000	RG-440/640	12 sq in	3" (76.2 mm)	3" (76.2 mm)	6-3/4" (171.0 mm)	4" (102.0 mm)	1-3/8" NC	9255-1120

Ordering Information - Tweco Ground Clamps with Cap Screws			
Amperage	Jaw Opening	Cable	Stock No.
500	2-1/2" - Depth 1-3/8" (63.5 mm - 34.9 mm)	1/2" Cap Screw	9210-1150
600	2-1/2" - Depth 1-3/8" (63.5 mm - 34.9 mm)	3/4" Cap Screw	9255-1075
600	2-1/2" - Depth 1-3/8" (63.5 mm - 34.9 mm)	Double Ball-Point	9210-1201
600	2-1/2" - Depth 1-3/8" (63.5 mm - 34.9 mm)	Tweco Male Plug	9210-1202

## Ground Clamp Accessories



## Roto-Ground Accessories

Ordering Information	
Lubricating Cup	9922-2129
Ball-Point Cable Connection Screw	9910-2424
Special Shaft Lubricant	9900-1123
Fiber Cover Screw	9940-2125



## Tweco Shaft Lubricant

- An electrical conductive grease to be used as a lubricant for roto-grounds and may be used when making mechanical connections with copper or aluminum cables
- Effective as a lubricant on sliding or moving electrical contacts such as switches and rotating grounding devices
- Apply generously to contact area from 1 oz (29.6 mL) or 8 oz (237.0 mL) plastic bottles. Reduce electrical resistance by as much as 40 to 50%

Ordering Information	
1 oz (29.6 mL) Plastic Squeeze Bottle	9900-1123
8 oz (237.0 mL) Plastic Squeeze Bottle	9900-1124



## Work Clamp Adapter

Ordering Information	
Work Clamp Adapter W/ 1-1/8"-7 UNC 2A OD Thread & 5/8"-11 UNC-2A ID Thread - Fits WCRG-600 Roto-Work Clamp	9922-2018
Work Clamp Adapter W/ 1-3/8"-6 UNC 2A OD Thread & 5/8"-11 UNC-2A ID Thread - Fits WCRG-1200 & WCRG-2000 Roto-Work Clamps	9922-2038

## "C" Type Clamp Parts

Ordering Information	
Cap Screw - 1/2" x 3/4" NC	9920-2100
Fitting-No.2 Male Plug (threaded 1/2" NC)	9920-2102
Fitting-Double Ball-Point (threaded 1/2"NC)	9920-2103
Cover	9940-2124



## Switchable Magnetic Work Holding Products

### Switchable Magnetic Ground Clamps



Easy Connect & Easy Release On/Off Knob

9255-1060



Just Turn Off & Wipe Away Debris

9255-1061



Cuts Set Up Time

9255-1062

#### Ordering Information

Amperage	Height	Width	Length	Weight	Std. Pkg.	Stock No.
200	2.5" (63.5 mm)	1.58" (40.1 mm)	2.19" (55.6 mm)	0.38 lbs	10	9255-1060
300	2.26" (57.4 mm)	1.58" (40.1 mm)	2.7" (68.6 mm)	0.61 lbs	10	9255-1061
600	2.6" (66.0 mm)	2.83" (71.9 mm)	4.09" (103.9 mm)	2.0 lbs	5	9255-1062

### Switchable Magnetic Multi-Angle Clamps



9255-1064



9255-1063

- Work-holding switchable magnetic products
- Holds flat, round, odd shaped products
- Perfect for cutting, drilling, grinding, beveling

#### Ordering Information

Description	Capacity/Power	Stock No.
Switchable Magnetic Multi Angle 300	Magnetic Power 150 lbs	9255-1064
Switchable Magnetic Multi Angle 400	Holding Power 400 lbs	9255-1063

### Switchable Magnetic Pick & Pack Lifters & Hooks



9255-1065



9255-1066

- Products to pick, place, slide and reposition steel base metals
- Ideal for small steel handling, dragging sheet, picking and pulling parts out of burn table or handling scrap

#### Ordering Information

Description	Capacity/Power	Stock No.
Switchable Magnetic Lifter Manual 60	Recommended Lift Capacity 60 lbs	9255-1065
Switchable Magnetic Lifter Hook 600	Lift Capacity 200 lbs	9255-1066

### Switchable Magnetic Right-Angle (90°) Clamp



9255-1067

- Holds base plate – flat or round – at 90-degree angles for perfect positioning for code work and precision welding or cutting
- Ideal for automated tables used in plasma cutting

#### Ordering Information

Description	Capacity/Power	Stock No.
Switchable Magnetic Right Angle 400	Holding Power 400 lbs	9255-1067

## Cable Lugs

EASY FIND GUIDE							
Style	Amperage Range						Recommended
	50	75	150	225	250	325	
Crimp Lugs for Welding Cable	[Yellow bar from 50 to 150]						T-62
	[Yellow bar from 50 to 225]						T-120
	[Yellow bar from 50 to 325]						T-3040
	[Yellow bar from 50 to 325]						T-40HD
Crimp Lugs for Power Cable	[Light blue bar from 50 to 75]						T-810
	[Light blue bar from 50 to 75]						T-68
	[Light blue bar from 50 to 75]						T-46
Ball-Point Lugs without Insulated Cover	[Black bar from 50 to 150]						10-45
	[Black bar from 50 to 150]						10-180
	[Black bar from 50 to 325]						40-45
	[Black bar from 50 to 325]						40-180
Ball-Point Lugs with Insulated Cover	[Yellow bar from 50 to 150]						10-45C
	[Yellow bar from 50 to 150]						10-180C
	[Yellow bar from 50 to 325]						40-45C
	[Yellow bar from 50 to 325]						40-180C
Heavy Duty Lugs	[Grey bar from 50 to 325]						140-HD-180
	[Grey bar from 50 to 325]						140-HD-180C
	[Grey bar from 50 to 325]						240-HD-180

Crimp Lugs



Ball-Point Lugs



Heavy Duty Lugs



## Cable Lugs

TwecoLugs - Crimp or Solder Type Lugs (Use Tweco "Lug-Set")



TwecoLugs (Crimp Lugs) for Welding Cable

Ordering Information					
Cable	Amp Rating	Stud Hole	I.D. Solder Socket	Std Pkg	Stock No.
6 thru 2	150	17/32" (13.5 mm)	.461" (11.7 mm)	50	9520-1115
6 thru 2	150	17/32" (13.5 mm)	.461" (11.7 mm)	5	9520-1104
1 thru 2/0	225	17/32" (13.5 mm)	.559" (14.2 mm)	50	9520-1116
1 thru 2/0	225	17/32" (13.5 mm)	.559" (14.2 mm)	5	9520-1105
3/0 & 4/0	250	17/32" (13.5 mm)	.660" (16.7 mm)	25	9520-1117
3/0 & 4/0	250	17/32" (13.5 mm)	.660" (16.7 mm)	5	9520-1107
4/0 Heavy Duty	325	21/32" (17.7 mm)	.776" (19.7 mm)	25	9520-1118
4/0 Heavy Duty	325	21/32" (17.7 mm)	.776" (19.7 mm)	5	9520-1109



TwecoLugs (Crimp Lugs) for Power Cable

Ordering Information					
Cable	Amp Rating	Stud Hole	I.D. Solder Socket	Std Pkg	Stock No.
8 thru 10	50	13/64" (5.2 mm)	.238" (6.1 mm)	10	9520-1101
6 thru 8	70	21/64" (8.3 mm)	.289" (7.3 mm)	10	9520-1102
4 thru 6	90	21/64" (8.3 mm)	.347" (8.8 mm)	10	9520-1103



Ball-Point Lugs without Insulated Cover

Ordering Information					
Description	Cable	Amp Rating	Stud Hole	Std Pkg	Stock No.
45° Angle	thru 1/0	150	17/32" (13.5 mm)	1	9515-1100
180° Offset	thru 1/0	150	17/32" (13.5 mm)	1	9515-1102
45° Angle	thru 4/0	325	17/32" (13.5 mm)	1	9515-1110
180° Offset	thru 4/0	325	17/32" (13.5 mm)	1	9515-1112



Ball-Point Lugs with Insulated Cover

Ordering Information					
Description	Cable	Amp Rating	Stud Hole	Std Pkg	Stock No.
45° Angle	thru 1/0	150	17/32" (13.5 mm)	1	9515-1101
180° Offset	thru 1/0	150	17/32" (13.5 mm)	1	9515-1103
45° Angle	thru 4/0	325	17/32" (13.5 mm)	1	9515-1111
180° Offset	thru 4/0	325	17/32" (13.5 mm)	1	9515-1113



Heavy Duty Mechanical Ball-Point Lugs

Ordering Information					
Description	Cable	Amp Rating	Stud Hole	Length	Stock No.
180° Offset	3/0 & 4/0	325	21/32" (16.7 mm)	4-3/8" (111 mm)	9515-1120
With Insulated Cover - 180° Offset	3/0 & 4/0	325	21/32" (16.7 mm)	5-1/2" (140 mm)	9515-1121
180° Offset	3/0 & 4/0	325	21/32" (16.7 mm)	4-5/8" (131 mm)	9515-1122

## Cable Connectors



### MPC Connectors

- Tweco MPC connectors provide a positive cam action, which optimizes interface between connector halves
- Equipped with heat and oil resistant covers
- Furnished with zinc plated cover and ball-point cable screws
- Interchangeable with older Tweco MBP Connectors
- The Whip Cable Connector is used when down sizing cable to an electrode holder
- It is a No. 2 male connector with cable hole sized to fit 4, 2, 1 or 1/0 cable
- The 2-1-MPC will fit any No. 2 or No. 4 female connector

### MPC Series

Positive-CAM Mechanical Connection - zinc plated type cable & cover screws

Ordering Information				
Description	Type Cable Connection	Cable Capacity	Standard Package	Stock No.
Complete Connection	Single Ball-Point	4, 2, 1	Pkg. 1 ea. Male & Female	9425-1100
Male Half	Single Ball-Point	4, 2, 1	Pkg. 2 ea. Male Only	9425-1110
Female Half	Single Ball-Point	4, 2, 1	Pkg. 2 ea. Female Only	9425-1120
Complete Connection	Single Ball-Point	1/0, 2/0, 3/0	Pkg. 1 ea. Male & Female	9425-1200
Complete Connection	Single Ball-Point	1/0, 2/0, 3/0	Pkg. 1 ea. Male & Female	9425-1201
Male Half	Single Ball-Point	1/0, 2/0, 3/0	Pkg. 2 ea. Male Only	9425-1210
Male Half	Single Ball-Point	1/0, 2/0, 3/0	Pkg. 2 ea. Male Only	9425-1211
Female Half	Single Ball-Point	1/0, 2/0, 3/0	Pkg. 2 ea. Female Only	9425-1220
Female Half	Single Ball-Point	1/0, 2/0, 3/0	Pkg. 2 ea. Female Only	9425-1221
Complete Connection	Double Ball-Point	3/0 or 4/0	Pkg. 1 ea. Male & Female	9425-1400
Complete Connection	Double Ball-Point	3/0 or 4/0	Pkg. 1 ea. Male & Female	9425-1401
Male Half	Double Ball-Point	3/0 or 4/0	Pkg. 2 ea. Male Only	9425-1410
Male Half	Double Ball-Point	3/0 or 4/0	Pkg. 2 ea. Male Only	9425-1411
Female Half	Double Ball-Point	3/0 or 4/0	Pkg. 2 ea. Female Only	9425-1420
Female Half	Double Ball-Point	3/0 or 4/0	Pkg. 2 ea. Female Only	9425-1422
Whip Connection	Single Ball-Point	4, 2, 1, 1/0	Pkg. 2 ea.	9425-1140

\*Sold in Master Pack Boxed Quantities of 48.

\*\*Sold in Master Pack Quantities of 24.

† Clamshell packaging. Sold individually or master packed in quantities of 24 each.

‡ Clamshell packaging. Sold individually or master packed in quantities of 12 each.

### Replacement Tapered Machine Plugs Ball-Point Connection



9505-1800

Ordering Information			
Taper Length	Taper Dimensions	Cable	Stock No.
1-1/8" (28.6 mm)	21/64" to 23/64" (8.3 mm x 9.1 mm)	4 thru 1	9505-1800
1-1/8" (28.6 mm)	21.64" to 23/64" (8.3 mm x 9.1 mm)	1/0 thru 3/0	9505-1801

### Cable Connector Replacement Parts

MPC Series Positive-CAM - Zinc plated type cable & cover screws

Ordering Information	
Description	Stock No.
Insulating Cover Only, All 1-MPC	9940-2103
Insulating Cover Only, All 2 & 4 MPC	9940-2124
Cable Connection Screw, Zinc Plated, All 2-MPC	9910-2124
Cable Connection Screw, Zinc Plated, All 4-MPC	9910-2424
Cover Screw, Zinc Plated, All MPC Connectors	9940-2125



9580-1102



9580-1103

### Panel Receptacles

For use with MPC Connectors

Ordering Information				
Cable Fitting Type	Fits Tweco Connector	For Cable Size	Cable Attachment	Stock No.
Ball-Point	No. 1	4, 2, 1	5/16" Ball-Point (7.9 mm)	9580-1100
Threaded	No. 1	4, 2, 1, 1/0	5/16" Thread. Stud (7.9 mm)	9580-1101
Threaded	No. 2, 4	1/0, 2/0, 3/0	3/8" Thread. Stud (9.5 mm)	9580-1102
Ball-Point	No. 2, 4	1/0, 2/0, 3/0	9/16" Ball-Point (14.3 mm)	9580-1103
Threaded	No. 2, 4	1/0, 2/0, 3/0	1/2" - 20 Thread. Stud (12.7 mm)	9580-1104

## Splicers, Terminals and Accessories

### Copper Cable Splicers



9610-1103

Ordering Information				
Cable	Amp Rating	Tube I.D.	Standard Package	Stock No.
6 thru 2	150	.461" (11.7 mm)	50	9610-1105
6 thru 2	150	.461" (11.7 mm)	5	9610-1101
1 thru 2/0	225	.599" (15.2 mm)	5	9610-1102
3/0 thru 4/0	250	.660" (16.8 mm)	5	9610-1103
4/0 Heavy Duty	325	.776" (19.7 mm)	5	9610-1104

### Ball-Point Cable Splicers



9605-1103

Ordering Information				
Cable	Amp Rating	Cable Fitting Type	Standard Package	Stock No.
4 thru 1/0		Ball-Point	1	9605-1101
1/0 thru 3/0		Ball-Point	1	9605-1103
2/0 thru 4/0		Double Ball-Point	1	9605-1105

### Tweco Terminals

9505-1152



9505-1811



### Tweco Terminals and TwecoLugs

Tweco Screw-On Terminals Fits Terminal Size 1/2" (12.7 mm) NC

Ordering Information	
Accepts Tweco Connector Number	Stock No.
No. 2 & No. 4 Male Half	9505-1152

### Receptacle Conversion Adapters

Ordering Information		
Fits Cam Locking Machine Receptacle	Fits Tweco Male Plug Ends	Stock No.
Large - 11/16" I.D. (17.5 mm)	No. 2-MPC, 4-MPC	9505-1811

### Tweco Female Terminals

Stud Hole Size 17/32" (13.5 mm)



9510-1100



9510-1101

Ordering Information			
Description	Accepts Male Ends	Standard Package	Stock No.
45° Angle	1-MPC	1	9510-1100
180° Offset	1-MPC	1	9510-1101
45° Angle	2-MPC, 4-MPC	1	9510-1110
180° Offset	2-MPC, 4-MPC	1	9510-1111

### Accessories

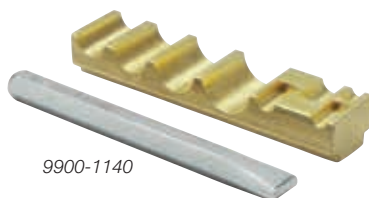

9900-1140

### Tweco "Lug-Set"

#### Block & Punch

For use with TwecoLugs

Ordering Information	
Description	Stock No.
Block & Punch	9900-1140



9900-1190

### Jacket Stripping Cable

#### Cutting Hand Tool

For use with lugs with an insulated cover

Ordering Information	
Description	Stock No.
Tweco Cable Cutting Hand Tool	9900-1190

# // GAS EQUIPMENT

ONLY ONE BRAND  
**CAN LEAD YOU  
TO VICTORY.**



# VICTOR

AN ESAB® BRAND



## CONTENTS

### GAS OUTFITS

Journeyman® EDGE 2.0 .....	99
Contender® EDGE 2.0 .....	99
Journeyman® II EDGE 2.0 .....	99
Performer® EDGE 2.0 .....	99
Journeyman® 450 .....	100
Medalist® 350 Classic.....	100
Journeyman® 350.....	100
Medalist® 250 Classic.....	100
Journeyman® Select EDGE 2.0 .....	101
Cutter™ Select ST 900FC EDGE 2.0.....	101
Cutter™ Select ST 2600FC EDGE 2.0.....	101
G150 Portable Tote .....	101
Fire-Stick Torch Kit .....	102
Powder Spray Torch Kit.....	102

### GAS CONTROL

Model Numbering Explanation.....	103
How to Read the Flow Data Charts:.....	104
Pressure Drop Reference Charts.....	105
Regulator Selection Guide - By Gas Service .....	106
EDGE Series Color Coding by Gas Type.....	107
Single Stage Regulators.....	113
Two Stage Regulators .....	113
EDGE™ Series.....	114
EDGE 2.0 Series Regulators.....	114
ESS42 EDGE 2.0 .....	115
ESS32 EDGE 2.0 .....	115
ESS32-PFH-800.....	116
SR 450.....	116
SR 350.....	117
SR 250.....	117
G350 .....	118
G250 .....	118
GF250.....	119
G150.....	119
ESS7 .....	119
VTS 700.....	120
VTS 250 .....	120
ETS4 Series .....	121
EHP Series .....	122
GT350.....	123
SR 4.....	123
ELC4.....	124
ESL4 .....	124
EST4 .....	125
SR 310/311/312 .....	125
Flowmeter .....	126

HRF 2400 PRO.....	127
DFM 150.....	127
HSR & HVTS.....	128
GRF 400 .....	129
TPR 250 Purging Regulator .....	129
MECO High Pressure .....	129

### HANDLES & CUTTING ATTACHMENTS

300 Series HD 310C Torch Handle.....	131
300 Series WH 315FC+ Torch Handle.....	131
100 Series 100FC Torch Handle.....	131
J Series - J-28 & J-40 Torch Handles.....	132
CA 2460+ Cutting Attachment .....	132
CA 1350 Cutting Attachment .....	132
CA 1260 Cutting Attachment .....	133
WH370 / WH270 Torch Handle .....	133
CA 370-V / CA 270-V Cutting Attachments .....	133
400 Series WH 411C Torch Handle.....	133
CA 411-1 Cutting Attachment .....	133
CA 411-3 Cutting Attachment .....	133

### NOZZLES

Type 55/55-1 Multi-Flame Heating Nozzles .....	135
Type 55 Components .....	135
MFN/MFN-1 Heating Nozzles .....	136
MFA/MFA-1 Heating Nozzles .....	136
Series 1 Heating Tips .....	137
CHT Adaptor .....	137
Welding Nozzles .....	137
Elbow Tips.....	138
UM Series Universal Mixers .....	138
RTE Series Replaceable Tip Ends.....	138
RTEN Series .....	138
FE Series Flexible Elbow .....	139
UN Series Universal Nozzle.....	139
DFE Series Dual Flexible Elbows .....	139
Replaceable Tip Ends.....	139

### GAS TORCHES

Victor “Universal Torches” .....	140
HC 1500C.....	140
Regulators .....	140
HC 1200C Series.....	142
Bulldog™ – HC 1100C.....	143
ST 2600FC Series .....	144
ST 1000FC Series .....	144
ST 900FC Series .....	145
ST 400C Series.....	145



ST 300FC Series .....	145
Victor Machine Torches .....	146
MT 300 Series .....	147
Pre-Drilled 1.38" (35.1 mm) Diameter Barrels .....	147
MT 5 .....	147
MT 200 Series .....	147
MT 1065.....	147
Gear Racks.....	147

## CUTTING TIPS

Series 1 – Acetylene Cutting Tips .....	149
Victor Series 1 Type 101.....	150
G-Series Series 1 Type 101 .....	150
Victor Series 1 Type 101 30° .....	151
Victor Series 1 Type 101-L .....	151
Victor Series 1 Type 108.....	151
G-Series Series 1 Type 108.....	151
Victor Series 1 Type 112.....	152
Victor Series 1 Type 118 Round) .....	152
G-Series Series 1 Type 118 (Round) .....	152
Victor Series 1 Type 118 (Sides Cutaway).....	152
G-Series Series 1 Type 118 (Sides Cutaway).....	152
Series 1 – Propylene Cutting Tips .....	153
Victor Series 1 Type GPP .....	154
G-Series Series 1 Type GPP .....	154
G-Series Series 1 Type GPP-P (Plated) .....	155
Victor Series 1 Type HPP .....	155
G-Series Series 1 Type HPP .....	155
Victor Series 1 Type MTHP .....	156
G-Series Series 1 Type MTHP.....	156
Victor Series 1 Type 303MP .....	157
G-Series Series 1 Type 303MP .....	157
Victor Series 1 Type BTMP .....	157
Victor Series 1 Type GTB .....	158
Victor Series 1 Type 318MP .....	158
G-Series Series 1 Type 318MP .....	158
Series 1 – LP Cutting Tips.....	159
Victor Series 1 Type 200 .....	160
Victor Series 1 Type 207 .....	160
Victor Series 1 Type 244 .....	160
Victor Series 1 Type MCN .....	160
Victor Series 1 Type GPN.....	161
G-Series Series 1 Type GPN .....	161
G-Series Series 1 Type GPN (Plated).....	162
Victor Series 1 Type MTHN .....	162
G-Series Series 1 Type MTHN.....	163
Victor Series 1 Type HPN .....	163

G-Series Series 1 Type HPN .....	164
Victor Series 1 Type BTN.....	164
Victor Series 1 Type CSN .....	164
Series 3 – Cutting Tips .....	165
Series 3 – Acetylene Cutting Tips .....	165
Victor Series 3 Type 101.....	165
G-Series Series 3 Type 101 .....	166
Victor Series 3 Type 118 (Round) .....	166
G-Series Series 3 Type 118 (Round) .....	166
Series 3 – Propylene Cutting Tips .....	166
Victor Series 3 Type GPP .....	166
G-Series Series 3 Type GPP .....	166
G-Series Series 3 Type 318MP .....	167
Series 3 – LP (Propane / Natural Gas) Cutting Tips .....	167
Victor Series 3 Type GPN .....	167
G-Series Series 3 Type GPN .....	167

## SAFETY ACCESSORIES

Flashback Arrestors and Check Valves.....	168
FlameBuster™ High Flow .....	169
FlameBuster™ .....	169
FlameBuster™ Plus .....	170
Flashback Arrestor with Kwik-Connect Coupling Components FBP-1 ...	170
Flashback Arrestors.....	170
Reverse Flow Check Valves .....	170
Built-in Flash Arrestor .....	170
Vanguard™ Flashback Arrestor .....	170
Kwik-Connect .....	170

## PORTABLE CUTTING MACHINES

VCM 200/201 Cutting Machines .....	171
------------------------------------	-----

## ACCESSORIES

Welding Accessory Tools .....	172
L1-Single Flint Striker .....	172
Triple Flint Striker .....	172
Flint Refills .....	172
TK Tank Key .....	172
Tip Cleaner .....	172



**1913**

The history of Victor begins in 1913 in San Francisco. The founder of Victor, Mr L.W. Stettner suffered a serious injury. A welder by trade, Stettner lost an eye during a welding accident, and following recovery, he was determined to design safer welding equipment and accessories – the birth of the Victor Torch.



**1941–1945**

Victor torches are integral to the war effort in World War II.

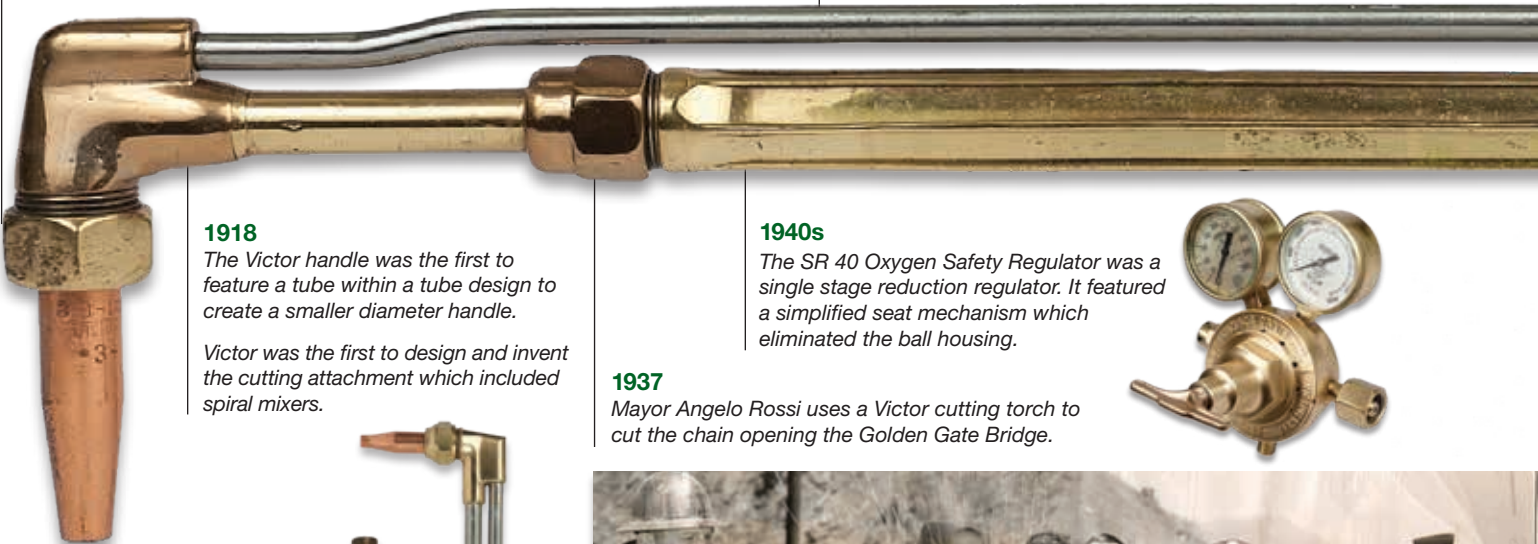

**1918**

The Victor handle was the first to feature a tube within a tube design to create a smaller diameter handle.

Victor was the first to design and invent the cutting attachment which included spiral mixers.

**1940s**

The SR 40 Oxygen Safety Regulator was a single stage reduction regulator. It featured a simplified seat mechanism which eliminated the ball housing.



**1937**

Mayor Angelo Rossi uses a Victor cutting torch to cut the chain opening the Golden Gate Bridge.



VICTOR



BY  
LUDWIG W. STETTNER  
INVENTOR

# EVOLUTION. INNOVATION. INSPIRATION.

**1980**

Victor began to manufacture the 315 welding handle with built-in check valves.



**1995**

Victor patents built-in flashback arrestors into their torches for added operator safety.



**2013**

Victor 400 series cutting torches with ergonomic handle and G Series regulators released.



**1966**

Victor Equipment Company moved to Denton, Texas.



**2009**

Victor introduced the EDGE™ regulator changing the landscape of gas regulation.



Victor manufacturing team worked overtime to produce over 5,000 pieces of equipment including special 15 and 20 foot length cutting torches to help with 9/11 clean-up efforts.



**2012**

The Golden Gate Bridge has its 75th Anniversary, Governor Schwarzenegger uses a Victor torch to recreate the original chain cutting ceremony.

**2014**

Victor becomes An ESAB Brand



## Journeyman® EDGE 2.0 Cutting, Heating and Welding Outfit

- Cuts up to 8 in. (203.2 mm), welds up to 3 in. (76.2 mm) with accessories
- Up to 1,118,000 BTUs/hour heating
- ESS42 Series regulators
- WH 315FC+ torch handle with built-in flash arrestors and check valves
- CA 2460+ cutting attachment
- Also includes cutting tip, tip cleaner, heating nozzle, striker, goggles, hose, welding nozzles and two EDGE 2.0 regulators



## Journeyman® II EDGE 2.0 Cutting and Welding Outfit

- Cuts up to 8 in. (203.2 mm), welds up to 3 in. (76.2 mm) with accessories
- ESS42 Series regulators
- WH 315FC+ torch handle with built-in flash arrestors and check valves
- CA 2460+ cutting attachment
- Also includes cutting tip, tip cleaner, heating nozzle, striker, goggles, hose, welding nozzles and two EDGE 2.0 regulators



### Ordering Information

Journeyman EDGE 2.0 540/300, 90° Plus Outfit	0384-2100
Journeyman EDGE 2.0 540/510, 90° Plus Outfit	0384-2101

### Ordering Information

Journeyman II EDGE 2.0 540/300, 90° Plus Outfit	0384-2110
Journeyman II EDGE 2.0 540/510, 90° Plus Outfit	0384-2111
Journeyman II AF EDGE 2.0 540/510LP, 90° Plus Outfit (propane)	0384-2112
Journeyman II AF EDGE 2.0 540/510LP, 90° Plus Outfit (propylene)	0384-2113

## Contender® EDGE 2.0 Cutting and Heating Outfit

- Cuts up to 8 in. (203.2 mm) and welds up to 3 in. (76.2 mm) with accessories
- ESS32 Series regulators
- WH 315FC+ torch handle with built-in flash arrestors and check valves
- CA 2460+ cutting attachment
- Also includes cutting tip, striker, hose, heating nozzle and two EDGE 2.0 regulators



## Performer® EDGE 2.0 Cutting, Heating and Welding Outfit

- Cuts up to 6 in. (152.4 mm) and welds up to 1/4 in. (6.4 mm) with accessories
- ESS32 Series regulators
- CA1350 cutting attachment
- WH100FC torch handle with built-in flashback arrestors and check valves
- Also includes cutting tip, tip cleaner, striker, goggles, hose, welding nozzle, heating nozzle and two EDGE 2.0 regulators



### Ordering Information

Contender 540/510 EDGE 2.0 Outfit	0384-2130
Contender 540/300 EDGE 2.0 Outfit	0384-2131
Contender AF 540/510LP EDGE 2.0 Outfit (propane & propylene tips)	0384-2132

### Ordering Information

Performer 540/510 EDGE 2.0 Outfit	0384-2125
Performer 540/300 EDGE 2.0 Outfit	0384-2126
Performer AF 540/510LP EDGE 2.0 Outfit (propane & propylene tips)	0384-2127

## Journeyman® 450

Heavy Duty Cutting and Welding Outfit

- Cuts up to 8 in. (203.2 mm) with optional tips
- Welds up to 3 in. (76.2 mm) with optional nozzles
- Heavy Duty Construction
- 315FC Torch handle with Flashback Arrestors and Built-in Check Valves
- SR 450 Series Regulators
- CA2460 Cutting Attachment
- Cutting Tips
- Welding Nozzle



Ordering Information	
Journeyman 450 540/510	0384-0807
Journeyman 450 540/300	0384-0808

## Journeyman® 350

Medium Duty Cutting and Welding Outfit

- Cuts up to 8 in. (203.2 mm) with optional tips
- Welds up to 3 in. (76.2 mm) with optional nozzles
- Medium Duty Construction
- Torch handle with Built-in Check Valves and Flashback Arrestors
- Series Regulators
- Cutting Attachment
- Cutting Tips
- Welding Nozzle



Ordering Information	
Journeyman 350 540/510	0384-0804
Journeyman 350 540/3000	0384-0805

GAS OUTFITS

## Medalist® 350 Classic

Heavy Duty Cutting and Welding Outfit

- Cuts up to 6 in. (152 mm) with optional tips
- Welds up to 3 in. (76 mm) with optional nozzles
- Heavy Duty Construction
- Torch handle has Built-in Check Valves and Flashback Arrestors
- One Cutting Attachment for all Fuel Gases (with proper tip)
- G350 Regulator features 2.5 in. (63 mm) Gauges



Ordering Information	
Medalist 350 Classic 540/510	0384-2698
Medalist 350 Classic 540/3000	0384-2699
Medalist 350LP Classic 540/510LP	0384-2710

## Medalist® 250 Classic

Medium Duty Cutting and Welding Outfit

- Cuts up to 5 in. (127.0 mm) with optional tips
- Welds up to 1.25 in. (31.8 mm) with optional nozzles
- Medium Duty Industrial Construction
- Torch handle has Built-in Check Valves and Flashback Arrestors
- One Cutting Attachment for all Fuel Gases (with proper tip)



Ordering Information	
Medalist 250 Classic 540/510	0384-2580
Medalist 250 Classic 540/300	0384-2581
Medalist 250LP Classic 540/510LP	0384-2584

## Journeyman® Select EDGE 2.0

### Heavy Duty Cutting Outfit

- Cuts up to 8 in. (203.2 mm) with optional tips
- WH 315FC torch handle with built-in flashback arrestors and check valves
- ESS42 Series regulators
- WH 315FC+ torch handle with built-in flash arrestors and check valves
- CA 2460+ cutting attachment



## Cutter™ Select ST 2600FC EDGE 2.0

### Heavy Duty Cutting Outfit

- Cuts up to 8 in. (203.2 mm) with accessories
- ST 2600FC cutting torch with built-in flashback arrestors and check valves
- ESS42 Series regulators
- Available with 90° head angle



#### Ordering Information

Journeyman Select EDGE 2.0 540/510, 90° Plus Outfit	0384-2081
Journeyman Select EDGE 2.0 540/510, 75° Plus Outfit	0384-2082
Journeyman Select EDGE 2.0 540/300, 90° Plus Outfit	0384-2083
Journeyman Select AF EDGE 2.0 540/510LP, 90° Plus Outfit	0384-2088

#### Ordering Information

Cutter EDGE 2.0 ST 2600FC 540/510, 90° Outfit	0384-2120
Cutter EDGE 2.0 ST 2600FC 540/300, 90° Outfit	0384-2121
Cutter AF EDGE 2.0 ST 2600FC 540/510LP, 90° Outfit	0384-2122

## Cutter™ Select ST900FC EDGE 2.0

### Heavy Duty Cutting Outfit

- Cuts up to 8 in. (203.2 mm) and welding up to 1/4 in. (6.4 mm) with accessories
- ESS32 Series regulators
- ST900FC Straight Cutting Torch with built-in flashback arrestors



## G150 Portable Tote

### Light Duty Portable Outfit

- Designed with a patented, molded, plastic carrying case
- Ergonomic handle
- Patented balance design with small footprint
- Built-in storage compartments
- Includes G-150 regulators



#### Ordering Information

Cutter 540/300 ST900FC EDGE 2.0 Outfit	0384-2140
Cutter 540/510 ST900FC EDGE 2.0 Outfit	0384-2141
Cutter AF 540/510LP ST900FC EDGE 2.0 Outfit	0384-2142

#### Ordering Information

G150-100-CP Tote w/o tanks	0384-0943
G150-100-CPT Tote w/ tanks	0384-0944
G150-J-P Tote w/o tanks	0384-0945
G150-J-PT Tote w/ tanks	0384-0946
G150-J-CP Tote w/o tanks	0384-0947
G150-J-CPT Tote w/ tanks	0384-0948
G150-J-AFP Tote w/o tanks	0384-0954
G150-J-AP Tote w/o tanks	0384-0955
G150-J-APT Tote w/ tanks	0384-0956
G150-J-ACP Tote w/o tanks	0384-0957
G150-J-ACPT Tote w/ tanks	0384-0958

## Fire-Stick Torch Kit

### Torch Kit

- This heating system can deliver up to 500,000 BTU's avg./hr.
- Two models available – with or without regulator
- For propane – (hose approved for LP)



#### Ordering Information

HT-500 Torch Kit, Fire-Stick, 500,000 BTU's	0384-1261
HS 101 Torch Kit, Fire-Stick, 350,000 BTU's	0384-1251

## Powder Spray Torch Kit

### Medium Duty Torch Kit

- The Victor VPT-100 provides powder feed into the gas mixture
- Deposit thickness is controlled by the powder flow rate of the torch
- 100 FC Torch Handle
- TE tips: size 3, 4
- TEMF tip: size 6
- 1 lb of Tungsten Carbide #600
- 1 lb of Nickel base #22
- Elbow assembly
- Hopper assembly



GAS OUTFITS

#### Ordering Information

VPT-100 Kit, 100FC Torch Handle, VPT Powder Torch, (3) Tips	0384-1265
---	-----------

## Model Numbering Explanation

Single or Two Stage model designations as well as those identifying delivery range are common to all regulators unless otherwise noted on individual ordering charts. When ordering be certain to specify delivery range, CGA inlet connections, and regulator part number.

### Regulator Ordering Matrix

XX  
↓

XXX  
↓

X  
↓

XXX  
↓

Single Stage Model		Series		Delivery Range		CGA Connection*			
SR	Single Stage	150	Light Duty	A	2-15 psig	CGA 200	Acetylene (MC)	CGA 580	Nitrogen, Argon, Helium
HSR	Single Stage with Flowmeter	250	Medium Duty	B	2-40 psig	CGA 300	Acetylene (Commercial)	CGA 590	Air (Industrial)
VTS	Two Stage Design	350	Heavy Duty	C	4-80 psig	CGA 320	Carbon Dioxide	CGA 660	Corrosive
HVTS	Two Stage with Flowmeter	450	Extra Heavy Duty	D	5-125 psig	CGA 326	Nitrous Oxide	CGA 677	Nitrogen, Argon & Helium
AR	Air Relieving			E	10-200 psig	CGA 346	Air (Formerly 1340)	CGA 680	Nitrogen, Argon
S	Station			F	50-750 psig	CGA 347	Air	CGA 701	Oxygen
L	Line			G	100-1500 psig	CGA 350	Fuel Gas, Hydrogen	CGA 992	British Oxygen & Inert Gas
HRF	Single Stage w/ Internal Flowmeter			J	200-3000 psig	CGA 500	Medical Mixtures	CGA 993	British Fuel Gas
AF	Argon Flow Gauge			K	300-4500 psig	CGA 510	Acetylene (POL)	CGA 996	Manifold Oxygen & Inert Gas
CF	CO2 Flow Gauge					CGA 510LP	Propane, Natural Gas, Propylene	CGA 997	Manifold Fuel Gas
DL	Dome Loaded					CGA 520	Acetylene (B)	CGA 024	Station Oxygen
BSL	Bulk System Line					CGA 540	Oxygen	CGA 025	Station Fuel Gas
DFM	Dual Flowmeter					CGA 555	Propane, Butane	CGA 034	Station Inert Gas
						CGA 577	Oxygen		

**Ordering Example: SR-250-D-540**

Single Stage, 250 Series, with 5-125 Delivery Range, for Oxygen Service CGA 540 Inlet

### Edge Series Regulator Ordering Matrix

X  
↓

XX  
↓

X  
↓

XXX  
↓

XXX  
↓

XX  
↓

Series	Type		Capacity		Max Delivery Pressure	CGA Connection*	Suffix		
E	EDGE Series	SS	Single Stage, Side Inlet	7	High Flow	15, 40, 80, 125, 200, 750, 1500, 3000, 4500	*Same as above Chart	R	Rear Entry
		LC	Liquid Cylinder	4	High Capacity			A	Acetylene
		ST	Station	3	Medium Capacity			F	Fuel Gas
		SL	Line					X	Oxygen
		TS	Two Stage					LP	Liquified Petroleum

**Ordering Example: ESS4-125-510LP**

Edge Series Single Stage, High Capacity w/ up to 125 Delivery Range, for Liquid Petroleum Service CGA 510 Inlet

### Regulator Delivery Ranges

A	2-15 psig	F	50-750 psig
B	2-40 psig	G	100-1500 psig
C	4-80 psig	J	200-3000 psig
D	5-125 psig	K	300-4500 psig
E	10-200 psig		

Outlet pressure delivery ranges are not minimum or maximum outlet pressure limits. Regulators can be adjusted to zero psig outlet pressure and generally, to pressures in excess of those specified. The use of these regulators to control pressures outside of the specified ranges is not recommended.

### Regulator Gauges

A Range	2-30 psig	F Range	50-1000 psig
B Range	2-60 psig	G Range	100-2000 psig
C Range	4-100 psig	J Range	200-4000 psig
D Range	5-200 psig	K Range	200-6000 psig
E Range	10-400 psig		

When ordering regulators, specify part numbers. Regulators should not be used as a shut-off valve nor should they be used to protect downstream equipment. Unless otherwise noted, high pressure gauges for all oxygen, inert gas, CO<sub>2</sub> and N<sub>2</sub>O, and hydrogen models are graduated 200-4000 psig. High pressure gauges for fuel gas models are graduated 10-400 psig. Low pressure or outlet gauge ranges are determined by the regulator delivery range selected.

GAS CONTROL



## How to Read the Flow Data Charts:

The regulator flow data is provided to assist in determining the proper regulator for the required application. The data is given for reference purposes only. If additional information is necessary contact your local distributor or the Customer Service Department at 1-800-426-1888

The regulator flow data was established by connecting a valve to the regulator outlet. The valve was opened and the flow rates measured. The amount of pressure drop is shown on the curves as the flow increases.

### Example

An SR 450D with an inlet of 2000 psig and an internal pressure setting of 125 psig (no flow) will flow 1000 SCFH, but the delivery pressure will drop to 115 lb. As the flow increased to 2000 SCFH, the pressure will drop to 108 psig.

With an inlet pressure of 200 psig and an initial setting of 125 psig, the regulator will flow 1000 SCFH with a pressure drop to 98 psig. At 2000 SCFH flow, the pressure will drop to 78 psig. If a delivery pressure other than the ones shown on the flow charts is required, use an average curve rate between the upper and lower pressures shown.

### Flow (SCFH)

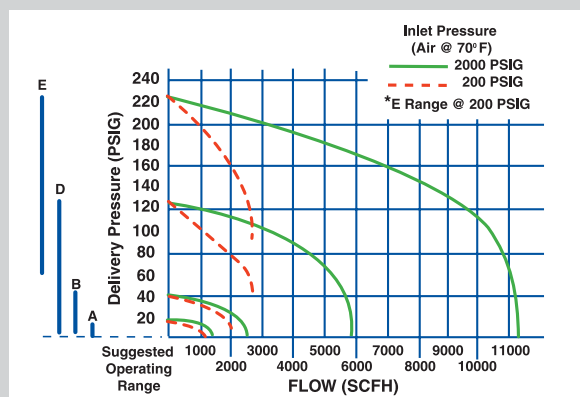

GAS CONTROL

### Delivery Pressure Rise

Single stage regulators have an increase in delivery pressure as the cylinder pressure decreases. Listed below is the amount of pressure increase per 100 psig decrease in cylinder (inlet) pressure.

ESS7-125	.95 psig
ESS7-200	1.54 psig
ESS3-125-540	.53 psig
SR 4 Series	J & K Range 4.8 psig
SR 5 Series	1.0 psig
SR 250 Series	0.5 psig
SR 350 Series	0.8 psig
SR 450 Series	0.6 psig
SR 700 Series	1.2 psig

The change in delivery pressure of a Two Stage regulator from full to empty Cylinder (inlet pressure) is negligible.

### For Conversion to Other Gases

All flow capacity information is given in SCFH of free air (1.00). For conversion to other gases multiply the air flow by the correction factor listed below.

- Acetylene..... 1.05
- Argon ..... 0.85
- Carbon Dioxide ..... 0.81
- Helium..... 2.69
- Hydrogen..... 3.79
- MAP-Pro™ ..... 0.82
- Natural Gas..... 1.28
- Nitrogen..... 1.02
- Oxygen ..... 0.95
- Propane ..... 0.80

## Pressure Drop Reference Charts

### Oxygen Hose

Delivery Pressure Pounds Per Square Inch	Oxygen Flow SCFH	Pressure Drop Pound Per Square Inch															
		Hose Length in Feet															
		3/16" Hose				1/4" Hose				5/16" Hose				3/8" Hose			
		12.5	25	50	100	12.5	25	50	100	12.5	25	50	100	12.5	25	50	100
10	100	5.0	6.3							*	*	*	2.3	*	*	*	2.0
	250					9.4	2.0	3.8	6.0	2.7	4.1	5.9		*	*	3.3	6.4
25	100	3.6	5.7	8.2	13.4	*	*	2.9	4.3	*	*	*	*	*	*	*	*
	250	13.2	18.3			6.3	7.9	11.7	16.8	*	2.4	3.2	6.7	*	*	*	3.7
	500					21.5				6.3	8.7	12.1	19.9	2.7	4.6	6.9	11.9
50	100	2.0	3.4	5.9	9.3	*	*	2.0	2.7	*	*	*	*	*	*	*	*
	250	8.0	12.6	19.4		2.7	5.0	7.9	11.0	*	*	2.2	3.9	*	*	*	2.6
	500					14.1	18.2			3.4	5.9	7.7	13.3	*	2.9	4.7	8.0
	750									8.8	12.3	17.8		3.8	6.0	9.8	10.9
75	100	*	2.6	3.8	7.1	*	*	*	2.8	*	*	*	*	*	*	*	*
	250	6.0	9.4	13.3	23.1	3.0	3.8	6.0	8.2	*	*	*	2.8	*	*	*	2.0
	500	19.7				10.7	13.8	19.8		2.5	3.9	6.3	9.4		2.0	3.4	5.9
	750					22.5				6.6	8.8	13.7	18.8	2.7	4.1	7.0	12.2
	1000									11.8	14.7	22.6		4.9	6.9	12.0	20.3
1000	100	*	*	2.7	4	*	*	*	*	*	*	*	*	*	*	*	*
	250	4.7	6.7	10.3	16.9	2.2	2.8	4.3	6.0	*	*	*	2.2	*	*	*	*
	500	14.1	21.0			8.1	10.8	15.0	21.2	2.0	2.9	4.4	7.1	*	*	2.1	4.6
	750					17.7	23.0	32.3	42.8	4.7	6.9	10.3	15.4	*	2.9	4.9	8.7
	1000					31.0	37.0	53.0	68.5	8.6	11.8	17.4		3.1	5.2	8.8	14.4
	1500					65.5	82.0			19.1				7.7	11.8	19.4	

GAS CONTROL

### Acetylene Hose

Delivery Pressure Pounds Per Square Inch	Acetylene Flow SCFH	Pressure Drop Pound Per Square Inch															
		Hose Length in Feet															
		3/16" Hose				1/4" Hose				5/16" Hose				3/8" Hose			
		12.5	25	50	100	12.5	25	50	100	12.5	25	50	100	12.5	25	50	100
5	25	0.3	0.5	1.0	1.8	**	**	0.5	0.8	**	**	**	0.3	**	**	**	**
	50	1.2	2.0	3.2		0.5	0.9	1.3	2.4	**	0.3	0.4	0.7	**	**	0.3	0.4
	75	2.6	3.9			1.2	1.8	2.6	4.5	0.4	0.5	0.8	1.4	**	0.3	0.5	0.8
	100	4.3				1.9	2.8	4.4		0.5	0.8	1.3	2.4	0.3	0.4	0.7	1.1
	150					4.0				1.2	1.7	2.7	4.8	0.5	0.8	1.2	2.2
10	25	0.3	0.5	0.8	1.4	**	**	0.3	0.7	**	**	**	**	**	**	**	**
	50	0.9	1.6	2.5	4.9	0.5	0.7	1.1	2.0	**	**	0.3	0.6	**	**	**	0.3
	75	2.0	3.1	6.3		0.9	1.4	2.2	3.7	0.3	0.4	0.5	0.6	**	**	0.3	0.6
	100	4.5	5.4			1.6	2.0	3.6	6.0	0.4	0.6	0.9	2.2	**	0.3	0.5	1.9
	150	7.0				3.2	4.5	7.3		0.9	1.3	2.1	3.9	0.4	0.6	1.0	2.5
	250					8.1				2.3	3.5	5.2	9.8	0.9	1.4	2.5	4.4
14	25	**	0.4		1.3	**	**	0.3	0.6	**	**	**	**	**	**	**	**
	50	0.8	1.4		4.6	0.4	0.6	0.9	1.6	**	**	**	0.4	**	**	**	0.3
	75	1.9	2.9		10.0	0.8	1.2	1.9	3.0	**	0.3	0.5	1.0	**	**	0.3	0.5
	100	3.5	5.1			1.4	2.0	3.0	4.7	0.3	0.6	0.7	1.7	**	0.3	0.4	0.8
	150	7.9				2.9	4.0	6.0	8.7	0.8	1.2	1.7	3.4	0.3	0.5	0.9	1.6
	250					7.4	9.5			2.0	3.1	4.5	8.1	0.7	1.2	2.3	3.8
	500									8.7	10.5	13.7		2.9	4.0	8.1	11.5

\*Indicates pressure drop of less than 2.0 per sq. in.

\*\*Indicates pressure drop of less than 0.2 per sq. in.

To obtain the recommended inlet pressure at the equipment, add the pressure drop figure (shown above) to the delivery pressure at the regulator. Do not exceed 15 psig for acetylene.

## Regulator Selection Guide – By Gas Service

### Oxygen

Description	Model	Part Number	Delivery Range (psig)	Gauge Range Inlet	Gauge Range Outlet	CGA Inlet Connection	Outlet Connection	Max Inlet Pressure (psig)
ESS7 High Capacity Single Stage	ESS7-125-540	0781-5181	5-125	4000	200	540	7/8" – 14 M RH	3000
ESS7 High Capacity Single Stage	ESS7-200-540	0781-5183	10-200	4000	400	540	7/8" – 14 M RH	3000
ESS42 EDGE 2.0 High Capacity Single Stage	ESS42-60-540	0781-3600	2-60	4000	60	540	9/16" – 18 M RH	3000
ESS42 EDGE 2.0 High Capacity Single Stage	ESS42-150-540	0781-3601	5-150	4000	200	540	9/16" – 18 M RH	3000
ESS32 EDGE 2.0 Medium Capacity Single Stage	ESS32-60-540	0781-3627	0-60	4000	200	540	9/16" – 18 M RH	3000
ESS32 EDGE 2.0 Medium Capacity Single Stage	ESS32-150-540	0781-3626	0-150	4000	200	540	9/16" – 18 M RH	3000
SR 450 Heavy Duty Single Stage	SR-450D-540	0781-0527	5-125	4000	200	540	9/16" – 18 M RH	3000
SR 350 Heavy/Medium Single Stage	SR-350D-540	0781-2341	5-125	4000	200	540	9/16" – 18 M RH	3000
VTS 700 Extra Heavy Duty Two Stage	VTS700E-540	0780-0939	10-200	4000	400	540	9/16" – 18 M RH	3000
ETS4 High Capacity Two Stage	ETS4-40-540	0781-5217	2-40	4000	60	540	9/16" – 18 M RH	3000
ETS4 High Capacity Two Stage	ETS4-125-540	0781-5218	5-125	4000	200	540	9/16" – 18 M RH	3000
ETS4 High Capacity Two Stage	ETS4-200-540	0781-5219	10-200	4000	400	540	9/16" – 18 M RH	3000
VTS 250 Medium Duty Two Stage	VTS250A-540	0781-3503	2-15	4000	30	540	9/16" – 18 M RH	3000
VTS 250 Medium Duty Two Stage	VTS250B-540	0781-3504	2-40	4000	60	540	9/16" – 18 M RH	3000
VTS 250 Medium Duty Two Stage	VTS250C-540	0781-3505	4-80	4000	100	540	9/16" – 18 M RH	3000
VTS 250 Medium Duty Two Stage	VTS250D-540	0781-3506	5-125	4000	200	540	9/16" – 18 M RH	3000
SR 4 High Pressure	SR4F-540	0781-1405	30-750	4000	1000	540	1/4" Swaglok®	3000
SR 4 High Pressure	SR4G-540	0781-1425	100-1500	4000	2000	540	1/4" Swaglok®	3000
SR 4 High Pressure	SR4J-540	0781-1445	200-3000	4000	4000	540	1/4" Swaglok®	3000
ELC4 High Capacity Liquid Cylinder	ELC4-125-540R	0781-5199	5-125	--	200	540	9/16" – 18 M RH	3000
ESL4 High Capacity Line	ESL4-125-250	0781-5190	5-125	--	200	1/4" NPT	1/4" NPT F	3000
EST4 High Capacity Station	EST4-40-024	0781-5191	2-40	--	60	024	9/16" – 18 M RH	200
EST4 High Capacity Station	EST4-40-024R	0781-5204	2-40	--	60	024	9/16" – 18 M RH	200
EST4 High Capacity Station	EST4-80-024	0781-5192	4-80	--	100	024	9/16" – 18 M RH	200
EST4 High Capacity Station	EST4-80-024R	0781-5205	4-80	--	100	024	9/16" – 18 M RH	200
EST4 High Capacity Station	EST4-125-024	0781-5193	5-125	--	200	024	9/16" – 18 M RH	200
EST4 High Capacity Station	EST4-125-024R	0781-5206	5-125	--	200	024	9/16" – 18 M RH	200
L700 High Flow Line	L700C-500	0780-1229	4-80	--	100	1/2" NPT F	1/2" NPT F	350
L700 High Flow Line	L700C-750	0780-1220	4-80	--	100	3/4" NPT F	3/4" NPT F	350
L700 High Flow Line	L700D-500	0780-1207	5-125	--	200	1/2" NPT F	1/2" NPT F	350
L700 High Flow Line	L700D-500PMT	0780-1236	5-125	--	200	1/2" NPT F	1/2" NPT F	350
L700 High Flow Line	L700D-750	0780-1209	5-125	--	200	3/4" NPT F	3/4" NPT F	350
L700 High Flow Line	L700E-500	0780-1221	10-200	--	400	1/2" NPT F	1/2" NPT F	350
L700 High Flow Line	L700E-750	0780-1222	10-200	--	400	3/4" NPT F	3/4" NPT F	350
DL700 Dome Load	DL700	0780-1188	5-125	--	--	1/2" NPT F	1/2" NPT F	500
BSL Bulk System Line	BSL700	0780-1200	10-200	--	400	1/2" NPT F	1/2" NPT F	350

GAS CONTROL

## Regulator Selection Guide – By Gas Service

### Acetylene

GAS CONTROL

Description	Model	Part Number	Delivery Range (psig)	Gauge Range Inlet	Gauge Range Outlet	CGA Inlet Connection	Outlet Connection	Max Inlet Pressure (psig)
ESS7 High Capacity Single Stage	ESS7-15-510	0781-5187	2-15	400	30	510	7/8" – 14 LH	3000
ESS7 High Capacity Single Stage	ESS7-200-350	0781-5186	10-200	4000	400	350	7/8" – 14 M LH	3000
ESS42 EDGE 2.0 High Capacity Single Stage	ESS42-15-510	0781-3602	2-15	400	30	510	9/16" – 18 M LH	3000
ESS42 EDGE 2.0 High Capacity Single Stage	ESS42-15-300	0781-3603	2-15	400	30	300	9/16" – 18 M LH	3000
ESS42 EDGE 2.0 High Capacity Single Stage	ESS42-15-993	0781-3604	2-15	400	30	993	9/16" – 18 M LH	3000
ESS42 EDGE 2.0 High Capacity Single Stage	ESS42-15-410	0781-3605	2-15	400	30	410	9/16" – 18 M LH	3000
ESS32 EDGE 2.0 Medium Capacity Single Stage	ESS32-15-510	0781-3628	0-15	400	30	510	9/16" – 18 M LH	3000
ESS32 EDGE 2.0 Medium Capacity Single Stage	ESS32-15-300	0781-3629	0-15	400	30	300	9/16" – 18 M LH	3000
SR 450 Heavy Duty Single Stage	SR460A-300	0781-0583	2-15	400	30	300	9/16" – 18 M LH	3000
SR 450 Heavy Duty Single Stage	SR460A-510	0781-0584	2-15	400	30	510	9/16" – 18 M LH	3000
SR 350 Heavy/Medium Single Stage	SR360A-300	0781-2400	2-15	400	30	300	9/16" – 18 M LH	3000
SR 350 Heavy/Medium Single Stage	SR360A-510	0781-2401	2-15	400	30	510	9/16" – 18 M LH	3000
SR 250 Medium Duty Single Stage	SR260A-300	0781-0085	2-15	400	30	300	9/16" – 18 M LH	3000
SR 250 Medium Duty Single Stage	SR260A-510	0781-0087	2-15	400	30	510	9/16" – 18 M LH	3000
VTS 700 Extra Heavy Duty Two Stage	VTS710A-510	0780-0984	2-15	400	30	510	7/8" – 14 M LH	3000
ETS4 High Capacity Two Stage	ETS4-15-300	0781-5229	2-15	400	30	300	9/16" – 18 M LH	3000
ETS4 High Capacity Two Stage	ETS4-15-510	0781-5230	2-15	400	30	510	9/16" – 18 M LH	3000
ETS4 High Capacity Two Stage	ETS4-15-993	07815-2122	2-15	400	30	993	9/16" – 18 M LH	3000
VTS 250 Medium Duty Two Stage	VTS260A-300	0781-3583	2-15	400	30	300	9/16" – 18 M LH	3000
VTS 250 Medium Duty Two Stage	VTS260A-510	0781-3484	2-15	400	30	300	9/16" – 18 M LH	3000
ESL4 High Capacity Line	ESL4-15-250A	0781-5208	2-15	--	30	1/4" NPT F	1/4" NPT F	350
EST4 High Capacity Station	EST4-15-025	0781-5194	2-15	--	30	025	9/16" – 18 M LH	200
EST4 High Capacity Station	EST4-15-025R	0781-5209	2-15	--	30	025	9/16" – 18 M LH	200
L700 High Flow Line	L710A-500	0780-1233	2-15	--	30	1/2" NPT F	1/2" NPT F	350
L700 High Flow Line	L710A-750	0780-1201	2-15	--	30	3/4" NPT F	3/4" NPT F	350

### EDGE Series Color Coding by Gas Type



<b>YELLOW</b>	<b>RED</b>	<b>GREEN</b>	<b>BLACK</b>	<b>GRAY</b>	<b>ORANGE</b>
<b>Air</b>	<b>Acetylene</b>	<b>Oxygen</b>	<b>Inert Gas</b>	<b>Carbon Dioxide</b>	<b>LPG</b>

## Regulator Selection Guide – By Gas Service

### Air

Description	Model	Part Number	Delivery Range (psig)	Gauge Range Inlet	Gauge Range Outlet	CGA Inlet Connection	Outlet Connection	Max Inlet Pressure (psig)
ESS42 EDGE 2.0 High Capacity Single Stage	ESS42-150-346	0781-3613	5-150	4000	200	346	5/8" – 18 F LH	3000
ESS42 EDGE 2.0 High Capacity Single Stage	ESS42-150-590	0781-3614	5-150	4000	400	590	5/8" – 18 F LH	3000
ESS32 EDGE 2.0 Medium Capacity Single Stage	ESS32-150-346	0781-3637	0-150	4000	200	346	5/8" – 18 F LH	3000
SR 450 Heavy Duty Single Stage	SR450D-346	0781-0532	5-125	4000	200	346	5/8" – 18 F LH	3000
ETS4 High Capacity Two Stage	ETS4-125-346	0781-5231	5-125	4000	200	346	5/8" – 18 F LH	3000
ETS4 High Capacity Two Stage	ETS4-200-346	0781-5232	10-200	4000	400	346	5/8" – 18 F LH	3000
ETS4 High Capacity Two Stage	ETS4-125-590	0781-5224	5-125	4000	200	346	5/8" – 18 F LH	3000
VTS 250 Medium Duty Two Stage	VTS250C-346	0781-3510	4-80	4000	100	346	5/8" – 18 F LH	3000
VTS 250 Medium Duty Two Stage	VTS250D-346	0781-3512	5-125	4000	200	346	5/8" – 18 F LH	3000
SR 4 High Pressure	SR4F-347	0781-1403	50-750	6000	1000	347	1/4" Swagelok®	5500
SR 4 High Pressure	SR4G-346	0781-1422	100-1500	4000	2000	346	1/4" Swagelok	3000
SR 4 High Pressure	SR4J-346	0781-1442	200-3000	4000	4000	346	1/4" Swagelok	3000
SR 4 High Pressure	SR4K-347	0781-1463	300-4500	6000	6000	347	1/4" Swagelok	5500
ESL4 High Capacity Line	ELS4-125-250	0781-5190	5-125	--	200	1/4" NPT F	1/4" NPT F	3000
L700 High Flow Line	L700C-500	0780-1229	4-80	--	100	1/2" NPT F	1/2" NPT F	350
L700 High Flow Line	L700C-750	0780-1220	4-80	--	100	3/4" NPT F	3/4" NPT F	350
L700 High Flow Line	L700D-500	0780-1207	5-125	--	200	1/2" NPT F	1/2" NPT F	350
L700 High Flow Line	L700D-500PMT	0780-1236	5-125	--	200	1/2" NPT F	1/2" NPT F	350
L700 High Flow Line	L700D-750	0780-1209	5-125	--	200	3/4" NPT F	3/4" NPT F	350
L700 High Flow Line	L700E-500	0780-1221	10-200	--	400	1/2" NPT F	1/2" NPT F	350
L700 High Flow Line	L700E-750	0780-1222	10-200	--	400	3/4" NPT F	3/4" NPT F	350
DL700 Dome Load	DL700	0780-1188	5-125	--	--	1/2" NPT F	1/2" NPT F	500

**Regulator Selection Guide – By Gas Service**

**Inert Gas – Nitrogen, Argon, Helium**

**GAS CONTROL**

Description	Model	Part Number	Delivery Range (psig)	Gauge Range Inlet	Gauge Range Outlet	CGA Inlet Connection	Outlet Connection	Max Inlet Pressure (psig)
ESS7 High Capacity Single Stage	ESS7-125-580	0781-5182	5-125	4000	200	580	7/8" – 14 M RH	3000
ESS7 High Capacity Single Stage	ESS7-200-580	0781-5185	10-200	4000	400	580	7/8" – 14 M RH	3000
ESS42 EDGE 2.0 High Capacity Single Stage	ESS42-150-580	0781-3609	5-150	4000	200	580	5/8" – 15 F RH	3000
ESS32 EDGE 2.0 Medium Capacity Single Stage	ESS32-60-580	0781-3633	0-60	4000	60	580	5/8" – 15 F RH	3000
ESS32 EDGE 2.0 Medium Capacity Single Stage	ESS32-150-580	0781-3634	0-150	4000	200	580	5/8" – 15 F RH	3000
SR 450 Heavy Duty Single Stage	SR450D-580	0781-0528	5-125	4000	200	580	5/8" – 18 F RH	3000
SR 450 Heavy Duty Single Stage	SR450E-580	0781-0543	10-200	4000	400	580	5/8" – 18 F RH	3000
VTS Extra Heavy Duty Two Stage	VTS700D-580	0780-0928	5-125	4000	200	580	7/8" – 14 M RH	3000
VTS Extra Heavy Duty Two Stage	VTS700E-580	0780-0943	10-200	4000	400	580	7/8" – 14 M RH	3000
ETS4 High Capacity Two Stage	ETS4-40-580	0781-5221	2-40	4000	60	580	5/8" – 18 F RH	3000
ETS4 High Capacity Two Stage	ETS4-125-580	0781-5222	5-125	4000	200	580	5/8" – 18 F RH	3000
ETS4 High Capacity Two Stage	ETS4-200-580	0781-5223	10-200	4000	400	580	5/8" – 18 F RH	3000
VTS 250 Medium Duty Two Stage	VTS250A-580	0781-3507	2-15	4000	30	580	5/8" – 18 F RH	3000
VTS 250 Medium Duty Two Stage	VTS250B-580	0781-3508	2-40	4000	60	580	5/8" – 18 F RH	3000
VTS 250 Medium Duty Two Stage	VTS250C-580	0781-3509	4-80	4000	100	580	5/8" – 18 F RH	3000
VTS 250 Medium Duty Two Stage	VTS250D-580	0781-3513	5-125	4000	200	580	5/8" – 18 F RH	3000
SR 4 High Pressure	SR4F-580	0781-1408	50-750	4000	1000	580	1/4" Swagelok®	3000
SR 4 High Pressure	SR4F-680	0781-1410	50-750	6000	1000	680	1/4" Swagelok	5500
SR 4 High Pressure	SR4G-580	0781-1428	100-1500	4000	2000	580	1/4" Swagelok	3000
SR 4 High Pressure	SR4G-680	0781-1430	100-1500	6000	2000	680	1/4" Swagelok	5500
SR 4 High Pressure	SR4J-580	0781-1448	200-3000	4000	4000	580	1/4" Swagelok	3000
SR 4 High Pressure	SR4J-680	0781-1450	200-3000	6000	4000	680	1/4" Swagelok	5500
SR 4 High Pressure	SR4J-677	0781-1453	200-3000	7500	4000	677	1/4" Swagelok	7500
SR 4 High Pressure	SR4K-680	0781-1470	300-4500	6000	6000	680	1/4" Swagelok	5500
SR 4 High Pressure	SR4K-677	0781-1473	300-4500	7500	6000	677	1/4" Swagelok	7500
ELC4 High Capacity Liquid Cylinder	ELC4-125-580R	0781-5200	5-125	–	200	580	CGA 032 5/8" – 18 UNF	3000
ELC4 High Capacity Liquid Cylinder	ELC4-325-580R	0781-5202	5-325	–	400	580	CGA 032 5/8" – 18 UNF	3000
EST4 High Capacity Station	EST4-125-034	0781-5189	5-125	–	200	034	CGA 032 5/8" – 18 UNF	200
EST4 High Capacity Station	EST4-125-034R	0781-5207	5-125	–	200	034	CGA 032 5/8" – 18 UNF	200
L700 High Flow Line	L700C-500	0780-1229	4-80	–	100	1/2" NPT F	1/2" NPT F	350
L700 High Flow Line	L700C-750	0780-1220	4-80	–	100	3/4" NPT F	3/4" NPT F	350
L700 High Flow Line	L700D-500	0780-1207	5-125	–	200	1/2" NPT F	1/2" NPT F	350
L700 High Flow Line	L700D-500PMT	0780-1236	5-125	–	200	1/2" NPT F	1/2" NPT F	350
L700 High Flow Line	L700D-750	0780-1209		–	200	3/4" NPT F	3/4" NPT F	350
L700 High Flow Line	L700E-500	0780-1221	10-200	–	400	1/2" NPT F	1/2" NPT F	350
L700 High Flow Line	L700E-750	0780-1222	10-200	–	400	3/4" NPT F	3/4" NPT F	350
DL700 Dome Load	DL700	0780-1188	5-125	–	–	1/2" NPT F	1/2" NPT F	500
BSL Bulk System Line	BSL700	0780-1200	10-200	–	–	1/2" NPT F	1/2" NPT F	350

## Regulator Selection Guide – By Gas Service

### Inert Gas – Nitrogen, Argon, Helium (continued)

Description	Model	Part Number	Delivery Range (psig)	Gauge Range Inlet	Gauge Range Outlet	CGA Inlet Connection	Outlet Connection	Max Inlet Pressure (psig)
ESS3-FG Flow Gauge	ESS3-FG-580	0781-5120	0-40 psig	4000	50 CFH	580	CGA 032 5/8" – 18 UNF	3000
SLR 100 Surge Limiting Regulator	SLR100	0781-1197		--	--	030		200
FM150 Flowmeter Heavy Duty	FM150	1000-0268	10-60 Air* 10-30 Nit*	--	--	1/4" NPT M	5/8"-18 RH F	25
FM135 Flowmeter Heavy Duty	FM135	1000-0255	4-18 Argon* 10-50 Helium*	--	--	9/16"-18 RH F	5/8"-18 RH F	25
FM145 Flowmeter Heavy Duty	FM145	1000-0256	4-18 Argon* 10-50 Helium*	--	--	5/8" RH M	5/8"-18 RH F	25
FM155 Flowmeter Heavy Duty	FM155	1000-0257	4-18 Argon* 10-50 Helium*	--	--	5/8" NPT M	5/8"-18 RH F	25
FM137 Flowmeter Heavy Duty	FM137	1000-0261	15-65 Argon* 40-200 Helium*	--	--	9/16"-18 RH F	5/8"-18 RH F	25
FM147 Flowmeter Heavy Duty	FM147	1000-0262	15-70 Argon* 40-200 Helium*	--	--	5/8"-18 RH M	5/8"-18 RH F	25
FM157 Flowmeter Heavy Duty	FM157	1000-0263	15-65 Argon* 40-200 Helium*	--	--	1/4" NPT M	5/8"-18 RH F	25
FM370 Flowmeter Heavy Duty	FM370	1000-0258	5-50 Argon* 20-150 Helium*	--	--	9/16"-18 RH F	5/8"-18 RH F	25
FM371 Flowmeter Heavy Duty	FM371	1000-0259	5-50 Argon* 20-150 Helium*	--	--	5/8"-18 RH M	5/8"-18 RH F	25
FM372 Flowmeter Heavy Duty	FM372	1000-0182	5-50 Argon* 20-150 Helium*	--	--	1/4" NPT M	5/8"-18 RH F	25
HRF 2425 Medium Duty Flowmeter Regulator	HRF2425	0781-2731	10-50 Argon* 20-150 Helium*	--	--	580	5/8"-18 RH F	3000
HRF2480 Medium Duty Flowmeter Regulator	HRF2480	0781-2728	7.5-37.5 Argon*	--	--	580	5/8"-18 RH F	3000
DFM 150 Medium Duty Flowmeter Regulator	DFM150-580	0781-1153	5-50 Argon* 20-150 Helium*	--	--	580	5/8"-18 RH F	3000
HSR Medium Duty Flowmeter Regulator Single Stage	HSR2530	0781-3819	10-60 Nitrogen*	--	--	580	5/8"-18 RH F	3000
HSR Medium Duty Flowmeter Regulator Single Stage	HSR2535	0781-3867	4-18 Argon* 10-50 Helium*	--	--	580	5/8"-18 RH F	3000
HVTS Medium Duty Flowmeter Regulator Two Stage	HVTS2535	0781-3775	4-18 Argon* 10-50 Helium*	--	--	580	5/8"-18 RH F	3000
HSR Medium Duty Flowmeter Regulator Single Stage	HSR2537	0781-3871	15-65 Argon* 40-200 Helium*	--	--	580	5/8"-18 RH F	3000
HVTS Medium Duty Flowmeter Regulator Two Stage	HVTS2537	0781-3772	15-65 Argon* 40-200 Helium*	--	--	580	5/8"-18 RH F	3000
HSR Medium Duty Flowmeter Regulator Single Stage	HSR2570	0781-3873	5-50*	--	--	580	5/8"-18 RH F	3000
HSR Medium Duty Flowmeter Regulator Single Stage	HSR2570	0781-3869	4-40*	--	--	580	5/8"-18 RH F	3000
HVTS Medium Duty Flowmeter Regulator Two Stage	HVTS2570	0781-3774	20-150*	--	--	580	5/8"-18 RH F	3000

\*Delivery range measured in CFH

GAS CONTROL

## Regulator Selection Guide – By Gas Service

### British Oxygen

Description	Model	Part Number	Delivery Range (psig)	Gauge Range Inlet	Gauge Range Outlet	CGA Inlet Connection	Outlet Connection	Max Inlet Pressure (psig)
ESS4 High Capacity Single Stage	ESS4-125-992	0781-5128	5-125	4000	200	992	9/16" – 18 M RH	3000
ETS4 High Capacity Two Stage	ETS4-125-992	0785-2120	5-125	4000	200	992	9/16" – 18 M RH	3000
ETS4 High Capacity Two Stage	ETS4-200-992	0785-2121	10-200	4000	400	992	9/16" – 18 M RH	3000
DL700 Dome Load	DL700	0780-1188	5-125	–	–	1/2" NPT F	1/2" NPT F	500

### Methane/Hydrogen

Description	Model	Part Number	Delivery Range (psig)	Gauge Range Inlet	Gauge Range Outlet	CGA Inlet Connection	Outlet Connection	Max Inlet Pressure (psig)
ESS7 High Capacity Single Stage	ESS7-200-350	0781-5186	10-200	4000	400	350	7/8" – 14 M RH	3000
ESS42 EDGE 2.0 High Capacity Single Stage	ESS42-150-350	0781-3612	5-150	4000	200	350	1/4" – 18 F	3000
ETS4 High Capacity Two Stage	ETS4-40-350	0781-5225	2-40	4000	60	350	9/16" – 18 M LH	3000
VTS 250 Medium Duty Two Stage	VTS252A-350	0781-3558	2-15	4000	30	350	9/16" – 18 M LH	3000
VTS 250 Medium Duty Two Stage	VTS252B-350	0781-3559	2-40	4000	60	350	9/16" – 18 M LH	3000
VTS 250 Medium Duty Two Stage	VTS252C-350	0781-3563	4-80	4000	100	350	9/16" – 18 M LH	3000
VTS 250 Medium Duty Two Stage	VTS252D-350	0781-3564	5-125	4000	200	350	9/16" – 18 M LH	3000
SR 4 High Pressure Manifold	SR4F-350	0781-1404	50-750	4000	1000	350	1/4" Swagelok®	3000
SR 4 High Pressure Manifold	SR4G-350	0781-1424	100-1500	4000	2000	350	1/4" Swagelok	3000
SR 4 High Pressure Manifold	SR4J-350	0781-1444	200-3000	4000	4000	350	1/4" Swagelok	3000
ESL4 High Capacity Line	ESL4-80-250F	0781-5210	4-80	–	100	1/4" NPT F	1/4" NPT F	3000
ESL4 High Capacity Line	ESL4-125-250F	0781-5211	5-125	–	200	1/4" NPT F	1/4" NPT F	3000
EST4 High Capacity Station	EST4-80-025	0781-5195	4-80	–	100	025	9/16" – 18 M LH	200
EST4 High Capacity Station	EST4-80-025R	0781-5212	4-80	–	100	025	9/16" – 18 M LH	200
EST4 High Capacity Station	EST4-125-025	0781-5196	5-125	–	200	025	9/16" – 18 M LH	200
EST4 High Capacity Station	EST4-125-025R	0781-5213	5-125	–	200	025	9/16" – 18 M LH	200
L700 High Flow Line	L711D-500	0780-1199	5-125	–	200	1/2" NPT F	1/2" NPT F	350
HSR Medium Duty Flowmeter Regulator Single Stage	HSR2533	0781-3825	5-40*	–	–	350	9/16" – 18 M LH	3000

### Nitrous Oxide

Description	Model	Part Number	Delivery Range (psig)	Gauge Range Inlet	Gauge Range Outlet	CGA Inlet Connection	Outlet Connection	Max Inlet Pressure (psig)
ESL4 High Capacity Line	ESL4-125-250	0781-5190	5-125	–	200	1/4" NPT F	1/4" NPT F	3000
DL700 Dome Load	DL700	0780-1188	5-125	–	–	1/2" NPT F	1/2" NPT F	500



# Regulator Selection Guide – By Gas Service

## Carbon Dioxide

Description	Model	Part Number	Delivery Range (psig)	Gauge Range Inlet	Gauge Range Outlet	CGA Inlet Connection	Outlet Connection	Max Inlet Pressure (psig)
ESS42 EDGE 2.0 High Capacity Single Stage	ESS42-150-320	0781-3615	5-150	4000	400	320	CGA 032 5/8" – 15 F RH	3000
ESS32 EDGE 2.0 Medium Capacity Single Stage	ESS32-150-320	0781-3638	0-150	4000	200	320	CGA 032 5/8" – 15 F RH	3000
ETS4 High Capacity Two Stage	ETS4-125-320	0781-5228	5-125	4000	200	320	CGA 032 5/8" – 18 UNF	3000
VTS 250 Medium Duty Two Stage	VTS253A-320	0781-3569	2-15	4000	30	320	CGA 032 5/8" – 18 UNF	3000
VTS 250 Medium Duty Two Stage	VTS253B-320	0781-3573	2-40	4000	60	320	CGA 032 5/8" – 18 UNF	3000
VTS 250 Medium Duty Two Stage	VTS253C-320	0781-3574	4-80	4000	100	320	CGA 032 5/8" – 18 UNF	3000
VTS 250 Medium Duty Two Stage	VTS253D-320	0781-3575	5-125	4000	200	320	CGA 032 5/8" – 18 UNF	3000
SR 4 High Pressure Manifold	SR4F-320	0781-1401	50-750	4000	1000	320	CGA 032 5/8" – 18 UNF	3000
ELC4 High Capacity Liquid Cylinder	ELC4-125-320R	0781-5201	5-125	–	200	320	CGA 032 5/8" – 18 UNF	3000
ESL4 High Capacity Line	ESL4-125-250	0781-5190	5-125	–	200	1/4" NPT F	1/4" NPT F	3000
DL700 Dome Load	DL700	0780-1188	5-125	–	–	1/2" NPT F	1/2" NPT F	500
ESS3-FG Flow Gauge	ESS3-FG-320	0781-5119	0-40*	4000	50 CFH	320	CGA 032 5/8" – 18 UNF	3000
SR310 Regulator Adjustable Pressure	SR310	0781-0355	10-150*	1500	200	320	CGA 032 5/8" – 18 UNF	1500
SR311 Flowmeter	SR311	0781-0353	25-100*	1500	–	320	CGA 032 5/8" – 18 UNF	1500
SR312 Flow Gauge	SR312	0781-0354	0-100*	–	–	320	CGA 032 5/8" – 18 UNF	1500
FM200 Heavy Duty Flowmeter	FM200	1000-0264	30-100*	–	–	1/4" NPT M	5/8"-18RH M	30
FM370 Flowmeter Heavy Duty	FM370	1000-0258	5-40*	–	–	9/16"-18 RH F	5/8"-18 RH F	25
FM371 Flowmeter Heavy Duty	FM371	1000-0259	5-40*	–	–	5/8"-18 RH M	5/8"-18 RH F	25
FM372 Flowmeter Heavy Duty	FM372	1000-0182	5-40*	–	–	1/4" NPT M	5/8"-18 RH F	25
HRF2480 Medium Duty Flowmeter Regulator	HRF2480	0781-2727	10-38*	–	–	320	5/8"-18 RH F	3000
HRF2480 Medium Duty Flowmeter Regulator	HRF2480	0781-2728	7.5-37.5*	–	–	320	5/8"-18 RH F	3000
DMF150 Medium Duty Flowmeter Regulator	DFM150S	0781-1206	5-40*	–	–	1/4" NPT M	5/8"-18 RH F	3000
HSR Medium Duty Flowmeter Regulator	HSR2530	0781-3819	10-60*	–	–	580	5/8"-18 RH F	3000

\*Delivery Range measured in CFH

## L.P. Gas

Description	Model	Part Number	Delivery Range (psig)	Gauge Range Inlet	Gauge Range Outlet	CGA Inlet Connection	Outlet Connection	Max Inlet Pressure (psig)
ESS7 High Capacity Single Stage	ESS7-125-510LP	0781-5188	5-125	400	200	510	7/8" – 14 M LH	350
ESS42 EDGE 2.0 High Capacity Single Stage	ESS42-60-510LP	0781-3606	2-60	510	60	510	9/16" – 18 M LH	350
ESS42 EDGE 2.0 High Capacity Single Stage	ESS42-150-510LP	0781-3607	2-150	510	200	510	9/16" – 18 M LH	350
ESS32 EDGE 2.0 Medium Capacity Single Stage	ESS32-60-510LP	0781-3631	0-60	510	60	510	9/16" – 18 M LH	350
SR450 Heavy Duty Single Stage	SR461B-510	0781-0589	2-40	400	60	510	9/16" – 18 M LH	350
SR450 Heavy Duty Single Stage	SR461D-510	0781-0595	5-125	400	200	510	9/16" – 18 M LH	350
SR 250 Medium Duty Single Stage	SR261B-510	0781-0095	2-40	400	60	510	9/16" – 18 M LH	350
SR 250 Medium Duty Single Stage	SR261C-510	0781-0098	4-80	400	100	510	9/16" – 18 M LH	350
VTS 250 Medium Duty Two Stage	VTS261B-510	0781-3594	2-40	400	60	510	9/16" – 18 M LH	350
VTS 250 Medium Duty Two Stage	VTS250BL-555	0781-3525	2-40	400	60	510	9/16" – 18 M LH	350
ESL4 High Capacity Line	ESL4-80-250F	0781-5210	4-80	–	100	1/4" NPT F	1/4" NPT F	3000
ESL4 High Capacity Line	ESL4-125-250F	0781-5211	5-125	–	200	1/4" NPT F	1/4" NPT F	3000
EST4 High Capacity Station	EST4-80-025	0781-5195	4-80	–	100	025	9/16" – 18 M LH	200
EST4 High Capacity Station	EST4-80-025R	0781-5212	4-80	–	100	025	9/16" – 18 M LH	200
EST4 High Capacity Station	EST4-125-025	0781-5196	5-125	–	20	025	9/16" – 18 M LH	200
EST4 High Capacity Station	EST4-125-025R	0781-5213	5-125	–	200	025	9/16" – 18 M LH	200
L700 High Flow Line	L711D-500	0780-1199	5-125	–	200	1/2" NPT F	1/2" NPT F	350

GAS CONTROL

## Single Stage Regulators

Recommended for applications where slight delivery pressure increases (due to decreasing cylinder pressures) would not affect the performance characteristics of the work or test results.

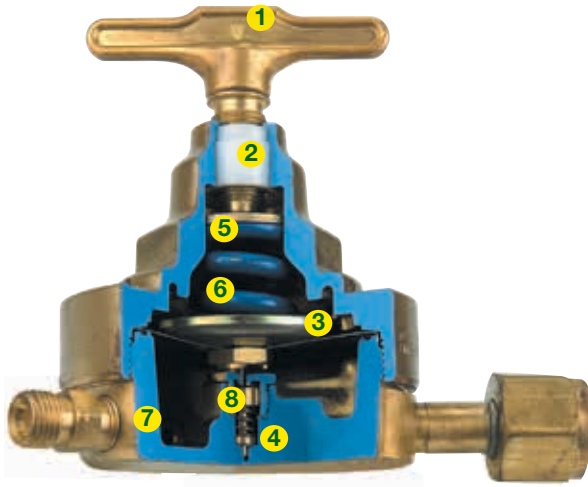

Typical Single Stage Design SR 450 Series Shown  
2.5 in. (63.5 mm) Brass Gauges External Relief Valve System

- 1 Brass Adjusting Screw with forged T-handle (SR 450 only)
- 2 Delrin Insert Bushing for durability, easier adjusting
- 3 Stainless Steel Diaphragm gives accurate long lasting service
- 4 Stem-Type Seat Mechanism inlet pressure aids in sealing
- 5 Stainless Ball in Key for easy adjustment
- 6 Adjusting Spring pretested for quality assurance
- 7 Die-Forged Brass Body for extra strength
- 8 Precision Machined Nozzle for optimum flow control

### Additional Features

- External self reseating relief valve. Not designed to protect downstream equipment (no relief valve is needed on low pressure fuel gas models)
- Sintered inlet filter, electroless nickel plated bronze
- Regulators will deliver at least the stated upper range and in some cases may exceed the stated upper range

## Two Stage Regulators

Recommended for applications that require a constant delivery pressure over a range of decreasing inlet pressures. This precise two stage regulator provides superior operating characteristics for applications where change in delivery pressure would affect performance characteristics of work or test results.



Typical Two Stage Design  
VTS 450 Series Shown  
2.5" (63.5 mm) Brass Gauges  
External Relief Valve System

### Additional Features

- 1 Brass Adjusting Screw with forged T-handle (VTS 700 only)
- 2 Delrin Insert Bushing for durability, easier adjusting
- 3 Die-Forged Brass Spring Housing Cap provides greater strength and durability
- 4 Stainless Steel Diaphragm gives accurate long lasting service
- 5 Stem-Type Seat Mechanism inlet pressure aids in sealing
- 6 Stainless Ball in Key for easy adjustment
- 7 Adjusting Spring pretested for quality assurance
- 8 Die-Forged Brass Body for extra strength
- 9 Precision Machined Nozzle for optimum flow control
- 10 Adjusting Spring designed for precise preset

### Additional Features

- External self reseating relief valve. Not designed to protect downstream equipment (no relief valve is needed on low pressure fuel gas models)
- Sintered inlet filter, electroless nickel plated bronze
- Regulators will deliver at least the stated upper range and in some cases may exceed the stated upper range

## EDGE™ Series

Innovative EDGE Series Regulators Offer Safety and Advanced Design

Victor has been the leader in gas equipment for one hundred years, and its tradition of unparalleled safety remains a cornerstone of the brand today. With the Victor Professional EDGE Series Regulators, Victor continues to offer the safest, most reliable and highest quality gas control technology, giving you more value for your purchase. In addition, standardized designs and components throughout the EDGE family greatly simplify regulator service and repair.

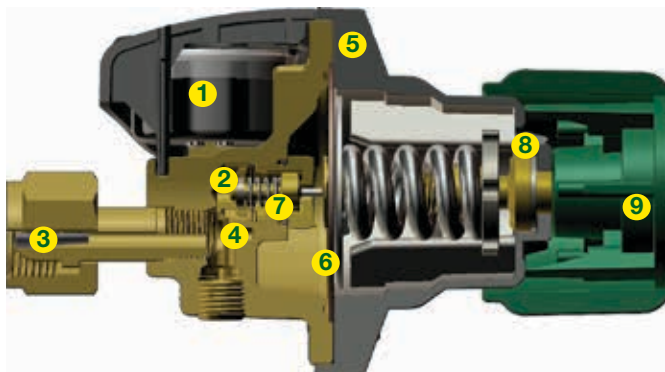

- 1 Gauges are recessed into the body for the highest level of safety and protection possible
- 2 More efficient internal flow paths translate to improved flow consistency from full to empty cylinder
- 3 Same sintered inlet filter used in all Victor industrial regulators
- 4 Innovative design elements enable the regulator to meet or exceed oxygen-related safety standards CGA E-4, UL 252, and the stringent ASTM G-175 Promoted Ignition Test
- 5 Housing cap is made from high strength zinc-aluminum alloy that has nearly twice the yield strength of forged brass
- 6 Time-tested fabric reinforced neoprene diaphragm provides superior sensitivity and control
- 7 Seat assembly and friction damper are the same tried and true components used for decades in SR 350 and SR 450
- 8 Internals remain protected from weather elements through an internal vent system protected under the knob, which is channeled to promote water run-off
- 9 SLAM™ Knob designed with multi-stage crumple zones which absorb impact energy in the event the cylinder falls over. Helps protect pressure integrity of both regulator and cylinder valve.



**Single Impact Point**

### 3-Stage Crumple Zone

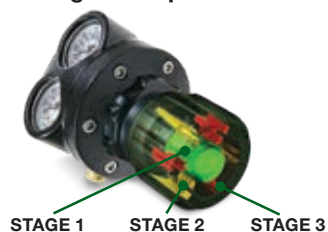

**Shock Absorbing Knob**

## EDGE 2.0 Series Regulators

High and Medium Capacity, Single Stage Regulators

Victor EDGE™ Series 2.0 patented regulators are second generation, heavy duty, high capacity single stage cylinder regulators that reset the standard for industrial regulators.

New and improved gauge designs incorporate larger faced delivery gauge (low pressure) with high contrasted colored face for easy setting. Enhanced color-coded knob designs provide more comfortable operations.

Air, Oxygen, Inert Gas, Methane, Hydrogen, Carbon Dioxide, Acetylene and LP Gas (see ordering information).

- Forged brass body
- External self reseating relief valve. Not designed to protect downstream equipment (no relief valve is needed on low pressure fuel gas models).
- Fully enclosed, highly visible modular gauges for more clarity with robust metal gauge guard
- Extra large 2 1/2 in. (63.5 mm) delivery gauge and stainless steel diaphragm
- Robust seat gives optimum performance
- Consistent pressure and flow delivery
- High resistance to oxygen related fires and SLAM knob absorbs impact in the event of a cylinder fall



## ESS42 EDGE 2.0

High Capacity, Single Stage

### Design/Construction

- Fully enclosed, highly visible modular gauges for more clarity with robust metal gauge guard
- Extra large 2 1/2 in. (63.5 mm) delivery gauge and stainless steel diaphragm
- Robust seat gives optimum performance
- Consistent pressure and flow delivery
- High resistance to oxygen related fires and SLAM knob absorbs impact in the event of a cylinder fall



## ESS32 EDGE 2.0

Medium Capacity, Single Stage

### Design/Construction

- Fully enclosed, highly visible modular gauges for more clarity with robust metal gauge guard
- Large 2 in. (50.8 mm) delivery gauge
- Robust seat gives optimum performance
- Consistent pressure and flow delivery
- High resistance to oxygen related fires and SLAM knob absorbs impact in the event of cylinder fall



GAS CONTROL

### ESS42 Flow Data

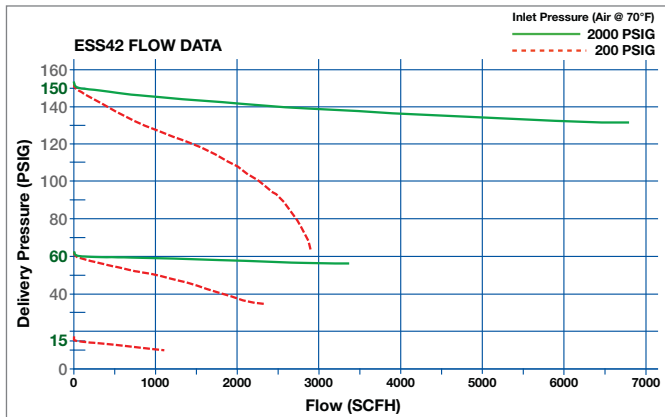

### ESS32 Flow Data

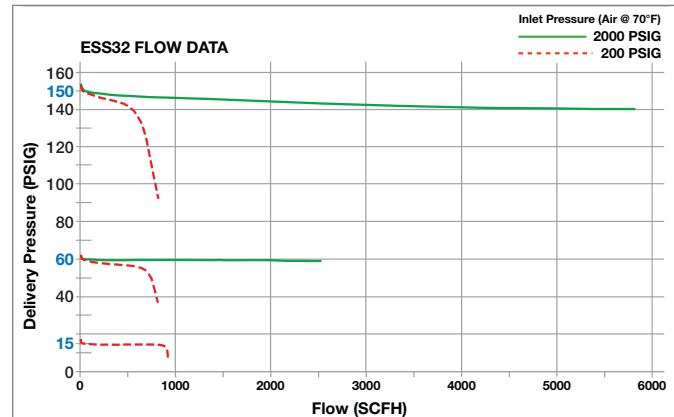

### Specifications

Dimensions L x W x H	Weight
4 x 6 x 4 in. (101.6 x 152.4 x 101.6 mm)	4.0 lbs (1.81kg)

### Specifications

Dimensions L x W x H	Weight
4 x 6 x 4 in. (101.6 x 152.4 x 101.6 mm)	4.0 lbs (1.81kg)

### Ordering Information

Gas Service	Part No.	Model No.	Delivery Range (psig)
Air, Oxygen, Inert Gas	0781-3600	ESS42-60-540 Oxygen	2-60
	0781-3601	ESS42-150-540 Oxygen	5-150
	0781-3613	ESS42-150-346 Air	5-150
	0781-3614	ESS42-150-590 Air	5-150
	0781-3609	ESS42-150-580 Inert Gas	5-150
Methane/Hydrogen	0781-3612	ESS42-150-350	5-150
Acetylene	0781-3602	ESS42-15-510	2-15
	0781-3603	ESS42-15-300	2-15
	0781-3604	ESS42-15-993	2-15
	0781-3605	ESS42-15-410	2-15
L.P. Gas	0781-3606	ESS42-60-510LP	2-60
	0781-3607	ESS42-150-510LP	2-150
Carbon Dioxide	0781-3615	ESS42-150-320	5-150

### Ordering Information

Gas Service	Part No.	Model No.	Delivery Range
Air, Oxygen, Inert Gas	0781-3627	ESS32-60-540 S/S Oxygen	0-60 psig
	0781-3626	ESS32-150-540 S/S Oxygen	0-150 psig
	0781-3633	ESS32-60-580 Inert	0-60 psig
	0781-3634	ESS32-60-580 Inert	0-150 psig
	0781-3637	ESS32-150-346 S/S Air	0-150 psig
	Methane/Hydrogen	0781-3635	ESS32-60-350 S/S Hydrogen
Acetylene	0781-3636	ESS32-150-350 S/S Hydrogen	0-150 psig
	0781-3628	ESS32-15-510 S/S Acetylene	0-15 psig
	0781-3629	ESS32-15-300 S/S Acetylene	0-15 psig
L.P. Gas	0781-3631	ESS32-60-510LP S/S LP	0-60 psig
Carbon Dioxide	0781-3638	ESS32-150-320 S/S CO2	0-150 psig
Ar-CO2	0781-3641	ESS32-80CFH-580 Ar-CO2 Flowgauge	0-80 cfh
	0781-3642	ESS32-80CFH-320 Ar-CO2 Flowgauge	0-80 cfh

## ESS32-PFH-800

### Pressure/Flow Hybrid Regulator

#### Design/Construction

- Nitrogen CGA-580 tool-less connection
- Fully enclosed, highly visible modular gauges for optimum clarity with robust metal gauge guard for maximum protection
- SLAM™ (Shock Limitation and Absorption Mechanism) technology built into the adjusting knob, provides additional strength, safety and protection of the regulator
- Up to 800 psi testing pressure



#### Specifications

Maximum Inlet	Outlet Connection	Gas Service
3000 psig	1/4 in. SAE Flare	Nitrogen
<b>Controlled Pressure and Flow</b>		
3 – 6 CFH (BRAZE)		
20 – 50 CFH (PURGE)		
200 – 800 PSIG (PRESSURE TEST)		
<b>Operating Temperature</b>		
0° – 120° F (-17.9 – 48.9° C)		
<b>Storage Temperature</b>		
-20° – 140° F (-28.9 – 60° C)		

#### Ordering Information

ESS32-PFH-580 Pressure-Flow Hybrid Regulator	0781-3652
--	-----------

## SR 450

### Heavy Duty

#### Design/Construction

- 2.5 in. (63.5 mm) gauges – brass
- 3.25 in. (82.6 mm) diaphragm – stainless steel



The shape of the SR450 Series regulator is a registered trademark of Victor.

#### Flow (SCFH)

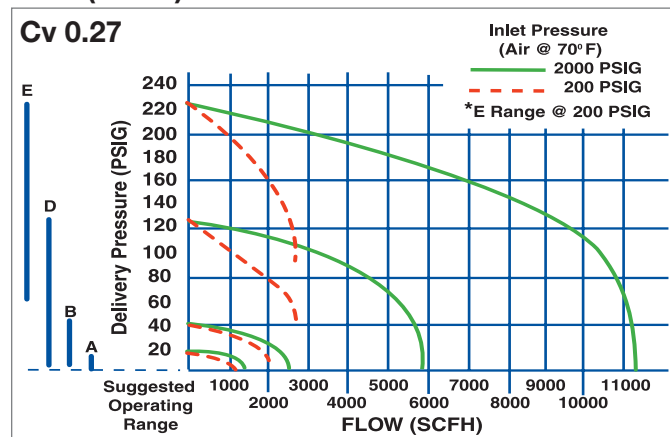

#### Specifications

Maximum Inlet	Dimensions L x W x H	Weight
3000 psig	5.13 x 7.25 x 7 in. (130.3 x 184.2 x 177.8 mm)	5 lbs 2 oz (2.32 kg)

#### Ordering Information

Gas Service	Part No.	Model No.	Delivery Range (psig)
Air, Oxygen, Inert Gas	0781-0532	SR 450D-346	5-125
	0781-0527	SR 450D-540	5-125
	0781-0528	SR 450D-580*	5-125
	0781-0543	SR 450E-580*	10-200
Acetylene	0781-0583	SR 460A-300	2-15
	0781-0584	SR 460A-510	2-15
L.P. Gas	0781-0589	SR 461B-510	2-40
	0781-0595	SR 461D-510	5-125

Outlet Connections: Cylinder Type – 9/16"-18 (M), \*9/16"-18 (F) RH

## SR 350

Heavy/Medium Duty

### Design/Construction

- High impact ABS gauge guard
- 1.5 in. (40 mm) gauges steel
- 2.7 in. (68.6 mm) diaphragm – fabric reinforced neoprene



## SR 250

Medium Duty

### Design/Construction

- 2 in. (50.8 mm) gauges – brass
- 1.75 in. (44.5 mm) diaphragm – fabric reinforced neoprene



GAS CONTROL

SR350 Flow Data - (Flowing Air at STD. Conditions)

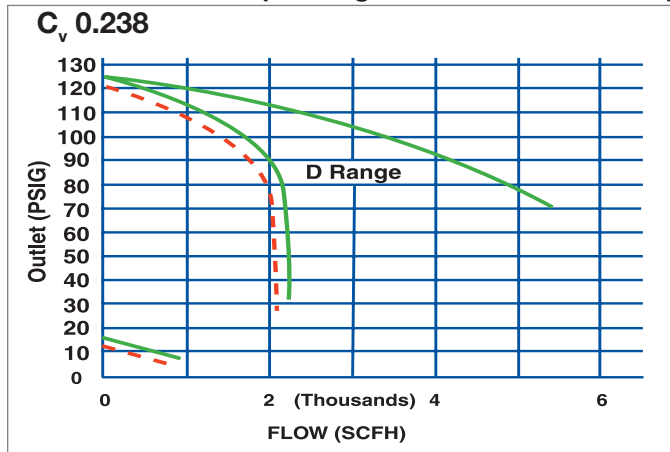

### Specifications

Maximum Inlet	Dimensions L x W x H	Weight
3000 psig	4.5 x 7.5 x 6.5 in. (114.3 x 190.5 x 165.1 mm)	4 lb (1.8 kg)

### Ordering Information

Gas Service	Part No.	Model No.	Delivery Range (psig)
Oxygen	0781-2341	SR 350D-540	5-125
Acetylene	0781-2400	SR 360A-300**	2-15
	0781-2401	SR 360A-510	2-15

Outlet Connections: Cylinder Type – 9/16"-18 (M), \*\*9/16"-18 (M) LH

SR250 Flow Data

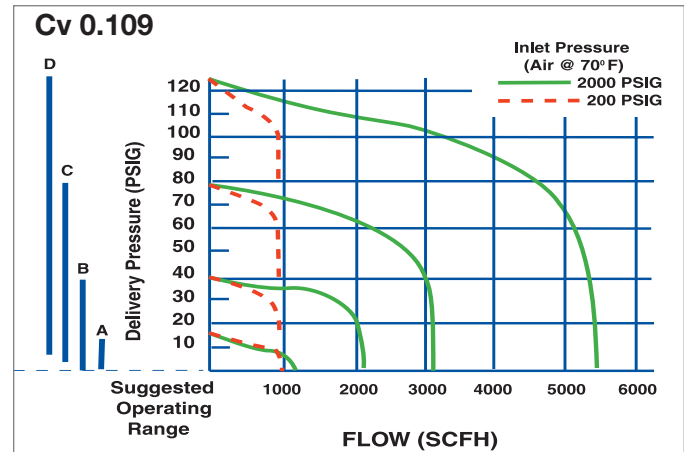

### Specifications

Maximum Inlet	Dimensions L x W x H	Weight
3000 psig	4.25 x 6.38 x 5.13 in. (108 x 162 x 130.3 mm)	2 lbs 15 oz (1.3 kg)

### Ordering Information

Gas Service	Part No.	Model No.	Delivery Range (psig)
Oxygen	0781-0027	SR 250C-540	4-80
	0781-0043	SR 250D-540	5-125
Acetylene	0781-0085	SR 260A-300	2-15
	0781-0087	SR 260A-510	2-15
	0387-0115	SR 260A-510 CS	2-15
L.P. Gas	0781-0095	SR 261B-510	2-40
	0781-0098	SR 261C-510	4-80

CS = Clamshell Packaging

Outlet Connections: Cylinder Type – 9/16"-18 (M)

## G350 Heavy Duty

### Design/Construction

- Larger regulator body for heavy duty applications
- Color coded knobs
- Forged brass body and Zinc Aluminum housing cap
- 2 1/2 in. (63 mm) high contrast gauges
- 9/16"-18 outlet connection
- Internal relief



## G250 Medium Duty

### Design/Construction

- Compact size for light to medium duty applications
- Acetylene, Oxygen and LP gas models
- Color coded knobs
- Single stage
- Forged brass body & Zinc Aluminum housing cap
- 2 in. (50.8 mm) gauges
- Delivery ranges vary based on model (see ordering information)
- 9/16"-18 outlet connection
- Internal relief



### G350 Flow Data

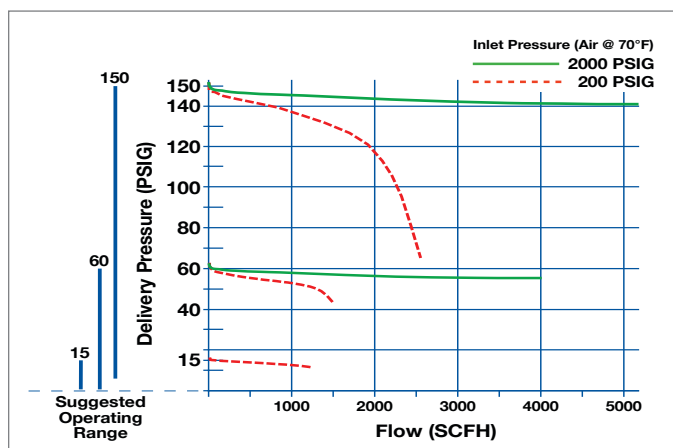

### Ordering Information

Gas Service	Part No.	Model No.	Delivery Range (psig)
Oxygen	0781-9433	G350-150-540	150
Acetylene	0781-9430	G350-15-510	15
	0781-9431	G350-15-300	15
	0781-9435 (WQ)	G350-15-510WQ	15
Inert	0781-0434	G350-150-580	150
LP	0781-9432	G350-60-510LP	60
Dual Packs	0781-3287	G350-150-540	150
		G350-15-510	15
	0781-3288	G350/300	60
		G350-15-300	15

### G250 Flow Data

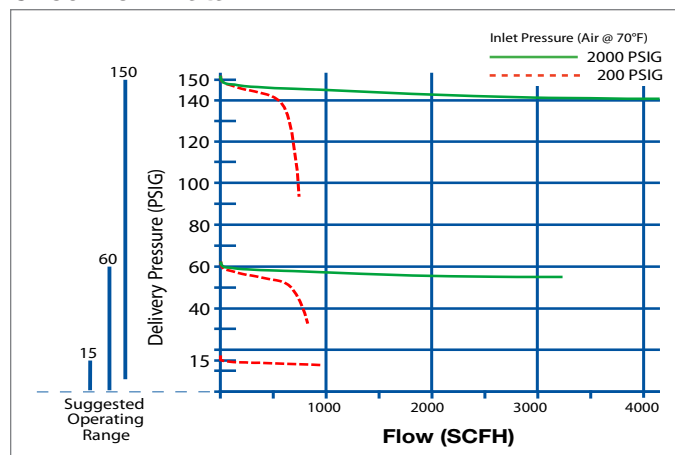

### Ordering Information

Gas Service	Part No.	Model No.	Delivery Range (psig)
Oxygen	0781-9400	G250-150-540	150
Acetylene	0781-9405	G250-15-510	15
	0781-9406	G250-15-300	15
LP	0781-9410	G250-60-510LP	60

GAS CONTROL

## GF250 Medium Duty

### Design/Construction

- Dual 2" gauges
- High strength alloy bonnet
- Single stage design
- Ergonomic adjusting knob
- For Argon or Argon/CO<sub>2</sub> mix shielding gases
- Color scale graphics with MIG and TIG ranges



### Specifications

Maximum Inlet	Weight
3000 psig	2.10 lbs (1.22 kg)

### Ordering Information

Part No.	Description
0781-9411	GF250-50-580
0781-9412	GF250-50-580 with 10 ft (3.1 m) hose

## G150 Light Duty, Single Stage, Cylinder Regulator

The G150 series, single stage, cylinder regulator is a compact, light weight regulator engineered for light duty applications.



### Design/Construction

- Ergonomic color-coded adjustment knob
- High contrast gauge face
- High strength alloy bonnet
- Compact design

### Ordering Information

G150-60-540	0781-4227
G150-60-540R	0781-4228
G150-60-540R 020 "A"	0781-4241
G150-15-510	0781-4233
G150-15-200	0781-4231
G150-15-200R	0781-4232
G150-15-200R 021 "A"	0781-4240
G150-15-520	0781-4235
G150-60-510LP	0781-4234
G150-60-580	0781-4229
G150-60-580 with hose	0781-4236
GF150-50-580 flowgauge	0781-4226
G150-60-320	0781-4230
GF150-50-320 with hose	0781-4237
GF150-50-320 flowgauge	0781-4225
SLR150 surge limiting	0781-1207

## ESS7 High Flow

### Design/Construction

- 2.5 in. (63.5 mm) gauges – brass
- 2.7 in. (68.6 mm) diaphragm – fabric reinforced neoprene



### ESS7 Flow Data - EDGE Series High-Flow

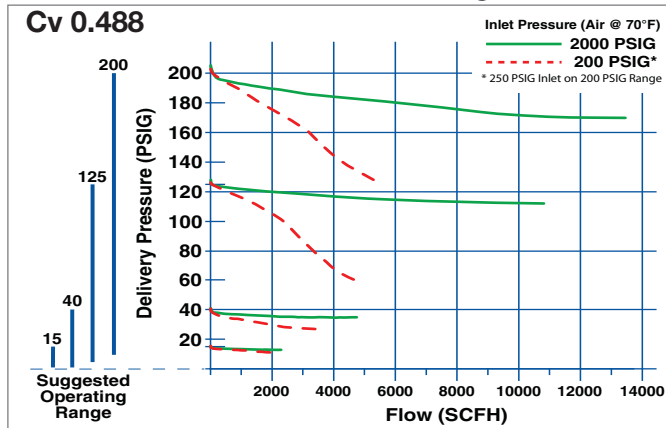

### Specifications

Dimensions L x W x H	Weight
5.4 x 6.8 x 6.9 in. (137.1 x 172.7 x 175.3 mm)	4.9 lbs (2.22 kg)

### Ordering Information

Gas Service	Part No.	Model No.	Delivery Range
Air, Oxygen, Inert Gas	0781-5184	ESS7-200-346	10-200
	0781-5181	ESS7-125-540	5-125
	0781-5183	ESS7-200-540	10-200
	0781-5220	ESS7-200-992	10-200
	0781-5182	ESS7-125-580	5-125
	0781-5185	ESS7-200-580	10-200
Methane/Hydrogen	0781-5186	ESS7-200-350	10-200
Acetylene	0781-5187	ESS7-15-510	2-15
L.P. Gas	0781-5188	ESS7-125-510LP	5-125

Outlet Connection 7/8"-14(M) like other regulators



### EDGE ADJUSTING LOCK

Ideal for setting pressures and avoiding tampering by others. Comes with three color decals - red, green, black.

Part No: 0750-0221 ● ● ●



## VTS 700

Extra Heavy Duty,  
Two Stage, High Flow

### Design/Construction

- 2.5 in. (63.5 mm) gauges – steel
- Diaphragms – 2 in. (50.8 mm) and 3.25 in. (82.6 mm) – stainless steel



### VTS 700 Flow Data

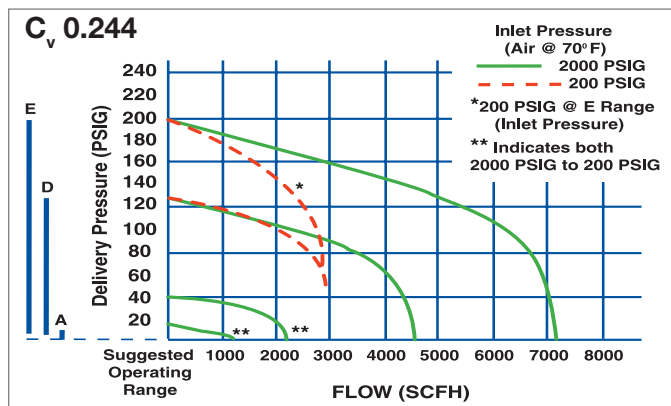

### Specifications

Maximum Inlet	Dimensions L x W x H	Weight
3000 psig	8.63 x 6.75 x 7.5 in. (219 x 171.5 x 190.5 mm)	8 lbs 8 oz (3.86 kg)

### Ordering Information

Gas Service	Part No.	Model No.	Delivery Range (psig)
Oxygen, Inert Gas	0780-0928	VTS 700D-580	5-125
	0780-0939	VTS 700E-540	10-200
	0780-0943	VTS 700E-580	10-200
Acetylene	0780-0984	VTS 710A-510	2-15

Outlet Connections: 7/8"-14(M)

## VTS 250

Medium Duty,  
Two Stage

### Design/Construction

- Delrin Insert Bushing for durability, easier adjusting
- Die-Forged Brass Spring Housing Cap provides greater strength and durability
- Fabric reinforced neoprene diaphragm gives long lasting service
- Stem-Type Seat Mechanism inlet pressure aides in sealing
- Stainless Ball in adjusting screw for easy adjustment
- Die-Forged Brass Body for extra strength
- Precision Machined Nozzle for optimum flow control
- Adjusting Spring designed for precise adjustment



### Additional Features

- External self reseating relief valve – Not designed to protect downstream equipment (no relief valve is needed on low pressure fuel gas models)
- Sintered inlet filter – electroless nickel plated bronze
- Regulators will deliver at least the stated upper range and in some cases may exceed the stated upper range

### Ordering Information

Gas Service	Part No.	Model No.	Delivery Range (psig)
Oxygen,	0781-3503	VTS250A-540	2-15
	0781-3504	VTS250B-540	2-40
	0781-3505	VTS250C-540	4-80
	0781-3506	VTS250D-540	5-125

Outlet Connections: 9/16"-18 (M RH)

## ETS4 Series

High Capacity,  
Two Stage Design

### Design/Construction

- Forged brass body
- Zinc-aluminum housing caps
- High impact ABS gauge guard
- 1.5 in. UL listed/recognized gauges – brass
- Stem type seat mechanism: urethane seat material – air, oxygen, inerts, CO<sub>2</sub>, N<sub>2</sub>O, other high pressure gases; neoprene seat material – low pressure fuel gases
- 2.7 in. fabric reinforced neoprene diaphragm in 2nd stage, 0.75 in. diameter brass piston in 1st stage
- External self reseating relief valve. Not designed to protect downstream equipment (no relief valve is needed on low pressure fuel gas models)
- Sintered inlet filter – nickel plated bronze
- SLAM impact absorbing safety knob
- Meets or exceeds CGA E-4, UL 252 and ASTM G-175 Promoted Ignition Test



GAS CONTROL

Specifications	
Dimensions L x W x H	Weight
4.72 x 6.85 x 4.4 in. (120 x 174 x 111.8 mm)	4 lbs 12 oz (2.15 kg)

Ordering Information			
Gas Service	Part No.	Model No.	Delivery Range (psig)
Air, Oxygen, Inert Gas	0781-5231	ETS4-125-346	5-125
	0781-5232	ETS4-200-346	10-200
	0781-5217	ETS4-40-540	2-40
	0781-5218	ETS4-125-540	5-125
	0781-5219	ETS4-200-540	10-200
	0781-5221	ETS4-40-580	20-40
	0781-5222	ETS4-125-580	5-125
Industrial Air	0781-5223	ETS4-200-580	10-200
	0781-5224	ETS4-125-590	5-125
British Oxygen/Fuel	0785-2120	ETS4-125-992	5-125
	0785-2121	ETS4-200-992	10-200
	0785-2122	ETS4-15-993	2-15
Hydrogen/Methane	0781-5225	ETS4-40-350	2-40
	0781-5226	ETS4-125-350	5-125
Carbon Dioxide	0781-5227	ETS4-200-350	10-200
	0781-5228	ETS4-125-320	5-125
Acetylene	0781-5229	ETS4-15-300	2-15
	0781-5230	ETS4-15-510	2-15

### ETS4 Flow Data

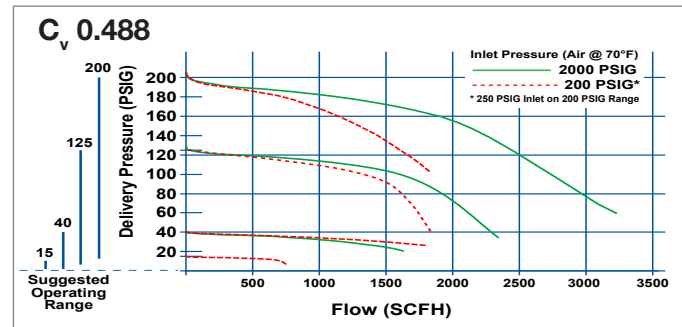

## EHP Series

### High Pressure

Developed specifically for applications which require higher deliver pressure (400 or 800 PSIG maximum) Provides even higher deliver capability than the SR 600 it's replacing.

#### Design/Construction

- Replaces SR 600 series
- Forged brass body
- High strength Zinc-Aluminum house cap
- High impact ABS gauge guard
- Color-coded SLAM impact absorbing safety knob



## GT350

### Heavy Duty, Two Stage Design

#### Design/Construction

- 2" (50.8 mm) gauges – steel
- Diaphragms –  
1.33" (33.8 mm) first stage  
2.69" (68.3 mm) second stage  
fabric reinforced neoprene

#### Dimensions

6.79" W x 5.31" H x 6.80" D  
(172.5 W x 134.9 H x 172.7 D mm)

#### Weight

3 lbs 12 oz (1.70 kg)

#### Performance

Maximum inlet – 3000 psig



Specifications		
Maximum Inlet	Dimensions L x W x H	Weight
3000 psig	6.25 x 6 x 6.5 in. (158.8 x 152.4 x 165 mm)	4 lbs (1.81 kg)

Ordering Information			
Gas Service	Part No.	Model No.	Delivery Range (psig)
Oxygen	0781-5170	EHP3-800-540	20-800
Inert Gas	0781-5168	EHP3-400-680	20-400
	0781-5171	EHP3-800-580	20-800
Air	0781-5169	EHP3-400-347	20-400

Inlet: \*1/4" NPT(F)

Outlet Fitting: 1/4" Swagelok type stainless steel.

+5/8"-20 UNF(M) inlet 1/8" NPT(F) outlet

## GT350 Two Stage Flow Data

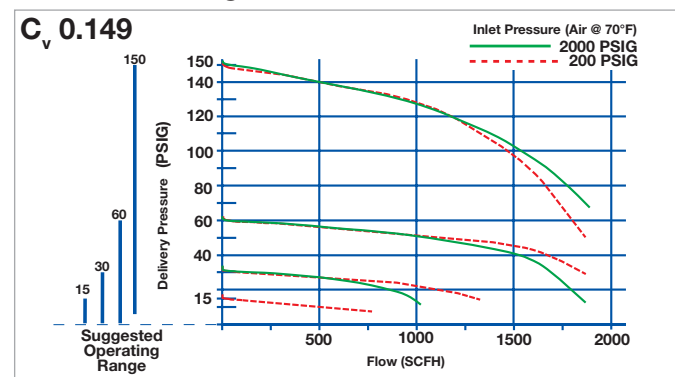

Ordering Information			
Gas Service	Part No.	Model No.	Delivery Range (psig)
Air, Oxygen, Inert Gas	0781-4255	GT350-150-346	5-150
	0781-4260	GT350-60-540	2-60
	0781-4261	GT350-150-540	5-150
	0781-4263	GT350-30-580	2-30
	0781-4264	GT350-60-580	2-60
British Oxygen/Fuel	0781-4265	GT350-150-580	5-150
	0781-4269	GT350-150-992	5-150
Hydrogen/Methane	0781-4270	GT350-15-993	2-15
	0781-4256	GT350-60-350	2-60
Carbon Dioxide	0781-4257	GT350-150-350	5-150
	0781-4253	GT350-60-320	2-60
Acetylene	0781-4254	GT350-150-320	5-150
	0781-4252	GT350-15-300	2-15
L.P. Gas	0781-4258	GT350-15-510	2-15
	0781-4259	GT350-60-510LP	2-60

## SR 4 High Pressure

Heavy duty, high pressure piston regulator. Ideally suited for pressure vessel and dead-end testing. Delivery pressures up to 4500 psig on some models.

### Design/Construction

- Machined brass body & housing cap
- 2.5 in. (63.5 mm) gauges – brass
- Cartridge type seat assembly with PCTFE seat
- Piston type actuation – brass
- Delrin cap bushing for smooth adjustments
- External adjustable relief valves on F and G range models
- Hydrogen models have ventable relief valves (J Series does not)
- Sintered inlet filter – bronze

### Panel Mounting Details

- All SR 4 Series regulator models may be panel mounted.
- 1.75 in. (44.5 mm) (hole required in panel for mounting).
- For a flush panel mount installation order one panel mount nut 1409-0093. For an adjustable panel mount installation order two panel mount nuts 1409-0093.



GAS CONTROL

Specifications		
Maximum Inlet	Dimensions L x W x H	Weight
7500 psig with CGA 677 6000 psig without inlet fitting 5500 psig with CGA 701, 680, 347 4000 psig with CGA 577 3000 psig with CGA 540, 580, 346, 350	6.25 x 6 x 6.5 in. (158.8 x 152.4 x 165.1 mm)	4 lbs (1.81 kg)

Ordering Information			
Gas Service	Part No.	Model No.	Delivery Range (psig)
Oxygen	0781-1405	SR 4F-540	50-750
	0781-1425	SR 4G-540	100-1500
	0781-1445	SR 4J-540	200-3000
Inert Gas	0781-1408	SR 4F-580	50-750
	0781-1410	SR 4F-680	50-750
	0781-1428	SR 4G-580	100-1500
	0781-1430	SR 4G-680	100-1500
	0781-1448	SR 4J-580	200-3000
	0781-1450	SR 4J-680	200-3000
	0781-1453	SR 4J-677	200-3000
	0781-1470	SR 4K-680	300-4500
	0781-1473	SR 4K-677	300-4500
	Air	0781-1403	SR 4F-347
0781-1422		SR 4G-346	100-1500
0781-1442		SR 4J-346	200-3000
0781-1463		SR 4K-347	300-4500
Methane, Hydrogen	0781-1404	SR 4F-350	50-750
	0781-1424	SR 4G-350	100-1500
CO <sub>2</sub>	0781-1444	SR 4J-350	200-3000
	0781-1401	SR 4F-320	50-750
Panel Mount 1/4" NPT Inlet	0781-1415	*SR 4PF-250	50-750
	0781-1420	*SR 4PG-250	100-1500
	0781-1455	*SR 4PJ-250	200-3000
	0781-1475	+SR 4PK-250	300-4500
	0781-1454	SR 4TJ-996	200-3000

Inlet: 1/4" NPT(F)  
 Outlet Fitting: 1/4" Swagelok type stainless steel.  
 +5/8"-20 UNF(M) inlet 1/8" NPT(F) outlet

### SR 4 FLOW DATA

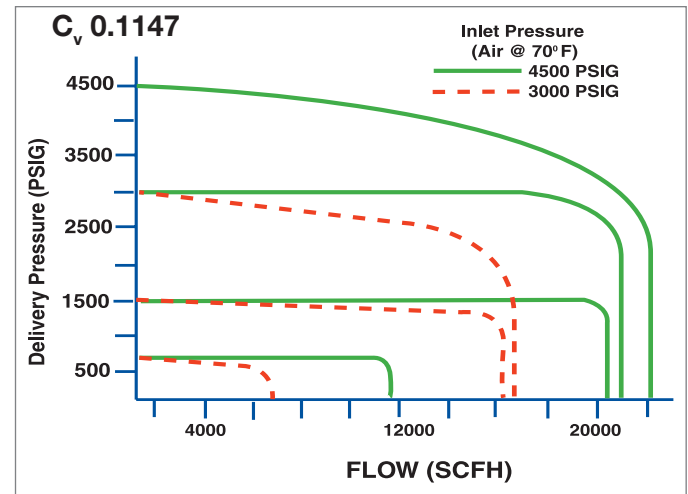

## ELC4 Liquid Cylinder

### Design/Construction

- Stainless diaphragm
- Rear entry design



## ESL4 Line Regulator

### Design/Construction

- Versatile – supports a variety of inlet pressures (up to 3000 psig)



GAS CONTROL

**ELC4 Flow Data - EDGE Series-Liquid Cylinder**

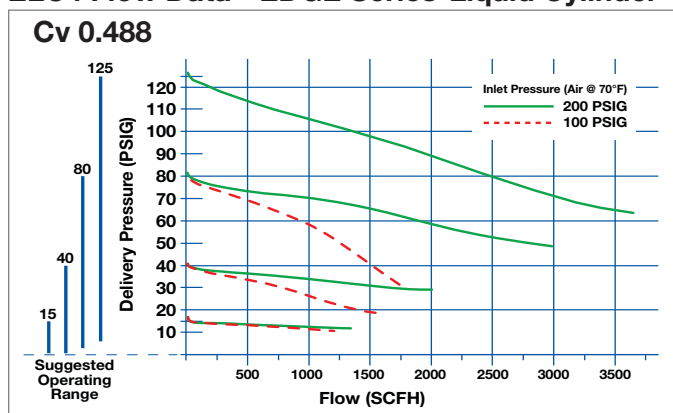

**ESL4 Flow Data - EDGE Series-Line**

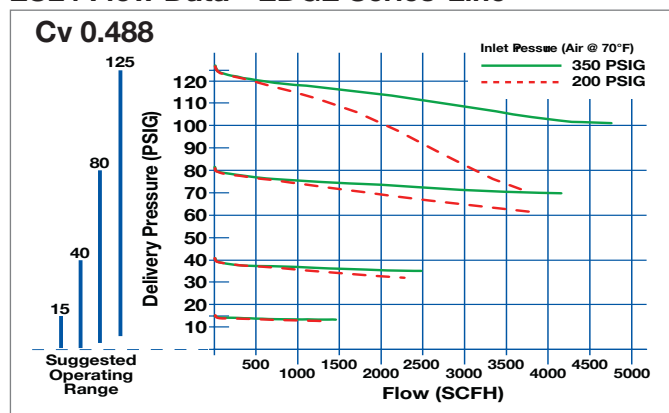

### Specifications

Maximum Inlet	Dimensions L x W x H	Weight
3000 psig	8.2 x 3.8 x 7 in. (208.3 x 96.5 x 180.3 mm)	4 lbs 5 oz (1.95 kg)

### Ordering Information

Gas Service	Part No.	Model No.	Delivery Range (psig)
Oxygen	0781-5199	ELC4-125-540R	5-125
Inert (Nitrogen, Argon, Helium)	0781-5200	ELC4-125-580R	5-125
	0781-5202	ELC4-325-580R	5-325
Carbon Dioxide	0781-5201	ELC4-125-320R	5-125

### Specifications

Maximum Inlet	Dimensions L x W x H	Weight
3000 psig	8.2 x 3.8 x 7 in. (208.3 x 96.5 x 180.3 mm)	4 lbs 5 oz (1.95 kg)

### Ordering Information

Gas Service	Part No.	Model No.	Delivery Range (psig)
Air, Inert Gas, Carbon Dioxide, Nitrous Oxide	0781-5190	ESL4-125-250	5-125
Oxygen	0781-5214	ESL4-125-250X	5-125
Hydrogen, Methane, Natural Gas, L.P. Gas	0781-5210	ESL4-80-250F	4-80
	0781-5211	ESL4-125-250F	5-125
Acetylene	0781-5208	ESL4-15-250A	2-15

## EST4 Station Regulator

### Design/Construction

- Side entry and rear entry inlet versions available



### EST4 Flow Data - EDGE Series-Station

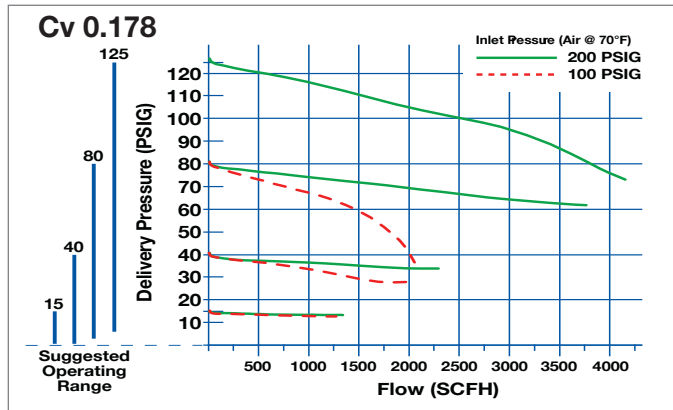

Specifications		
Maximum Inlet	Dimensions L x W x H	Weight
3000 psig	8.2 x 3.8 x 7 in. (208.3 x 96.5 x 180.3 mm)	4 lbs 5 oz (1.95 kg)

Ordering Information			
Gas Service	Part No.	Model No.	Delivery Range (psig)
Oxygen	0781-5191	EST4-40-024	2-40
	0781-5204	EST4-40-024R	2-40
	0781-5192	EST4-80-024	4-80
	0781-5205	EST4-80-024R	4-80
	0781-5193	EST4-125-024	5-125
	0781-5206	EST4-125-024R	5-125
Inert (Nitrogen, Argon, Helium)	0781-5189	EST4-125-034	5-125
	0781-5207	EST4-125-034R	5-125
Acetylene	0781-5194	EST4-15-025	2-15
	0781-5209	EST4-15-025R	2-15
Hydrogen, Methane, Natural Gas, L.P. Gas	0781-5195	EST4-80-025	4-80
	0781-5212	EST4-80-025R	4-80
	0781-5196	EST4-125-025	5-125
	0781-5213	EST4-125-025R	5-125

## SR 310/311/312 Flowmeter

### Design/Construction

- Designed for CO<sub>2</sub> application (non-siphoned tube cylinders)
- High flow CO<sub>2</sub> applications (SR 310 100 psig) with adequate supply or source
- Designed for core wire applications
- Machined aluminum body & housing cap
- 2 in. (50.8 mm) gauge
- Stem type seat mechanism
- 1.75 in. (44.5 mm) diaphragm – fabric reinforced neoprene
- Self reseating relief valve (not designed to protect downstream equipment)
- Sintered inlet filter – bronze



A regulator equipped with a flow gauge is not accurate when a back pressure in excess of 2 psig exists at the outlet. Back pressure is caused by a restriction in the equipment downstream of the flow gauge. Metering valves, kinked hoses or even very long hoses are restrictions that can cause back pressure. In applications where back pressure in excess of 2 psig can be expected, a regulator equipped with a flowmeter should be used.

Specifications	
Maximum Inlet	Delivery Range
1500 psig	100 SCFH
Dimensions L x W x H	Weight
2.5 x 8.38 x 7.25 in. (63.5 x 212.9 x 184.2 mm)	2 lbs 15 oz (1.33 kg)

Ordering Information		
Model	Diameter	Part No.
SR 310 Adjustable Pressure Gauge	2 in. (50.8 mm)	0781-0355
SR 311 (Preset @ 80 psig) Flowmeter	2 in. (50.8 mm)	0781-0353
SR 312 Flow Gauge	2 in. (50.8 mm)	0781-0354

**WARNING:** High gas withdrawal rates may cause regulator freeze up and will require cylinder manifold. Consult your gas supplier. See below for Gas Heater.

## Flowmeter

### Heavy Duty

#### Design/Construction

- Gas flow measurement in SCFH
- MIG / TIG applications
- Flowtube and outer tube are made of impact resistant lexan for severe applications
- Pressure compensated for low surge requirement
- Cover tube contains overpressure protection

All Victor flowmeters are back pressure compensated to ensure accurate readings at all times, even if line restrictions are present. All flowmeters are calibrated to operate at 25 psig inlet pressure to minimize surge, except the FM 200 which is calibrated to operate at 80 psig.

**WARNING:** Not designed for cylinder use.  
Do not exceed calibrated inlet pressure.



#### Ordering Information

Part No.	Model No.	Flow Range (SCFH)	Inlet Fitting	Outlet Fitting	Replacement Flow Tube	Inlet Pressure (psig)
<b>Units with single gas calibration</b>						
1000-0264	FM 200	30-100 CO <sub>2</sub>	1/4" NPT(M)	5/8"-18 RH(F)	1015-0066	80
<b>Units with 2 gas calibrations</b>						
1000-0268	FM 150	10-60 Air, 10-60 Nitrogen	1/4" NPT(M)	5/8"-18 RH(F)	1015-0060	25
1000-0255	FM 135	4-18 Argon , 10-50 Helium	9/16"-18 RH(F)	5/8"-18 RH(F)	1015-0063	25
1000-0256	FM 145	4-18 Argon, 10-50 Helium	5/8"-18 RH(M)	5/8"-18 RH(F)	1015-0063	25
1000-0257	FM 155	4-18 Argon, 10-50 Helium	1/4" NPT(M)	5/8"-18 RH(F)	1015-0063	25
1000-0261	FM 137	15-65 Argon, 40-200 Helium	9/16"-18 RH(F)	5/8"-18 RH(F)	1015-0064	25
1000-0262	FM 147	15-70 Argon, 40-200 Helium	5/8"-18 RH(M)	5/8"-18 RH(F)	1015-0064	25
1000-0263	FM 157	15-65 Argon, 40-200 Helium	1/4" NPT(M)	5/8"-18 RH(F)	1015-0064	25
<b>Units with 3 gas calibrations</b>						
1000-0258	FM 370	5-40 CO <sub>2</sub> , 5-50 Argon, 20-150 Helium	9/16"-18 RH(F)	5/8"-18 RH(F)	1015-0057	25
1000-0259	FM 371	5-40 CO <sub>2</sub> , 5-50 Argon, 20-150 Helium	5/8"-18 RH(M)	5/8"-18 RH(F)	1015-0057	25
1000-0182	FM 372	5-40 CO <sub>2</sub> , 5-50 Argon, 20-150 Helium	1/4" NPT(M)	5/8"-18 RH(F)	1015-0057	25

To ensure proper gas flow and to prevent tampering to your flowmeter use a Victor Locking Valve (Part No. 0662-0079).

## HRF 2400 PRO Medium Duty, Flowmeter

### Performance

- 70 CFH Flow Rate to support MIG / TIG and other high flow applications
- Ideal for all applications where superior dependability is needed
- Newly designed flow tube with improved scale visibility
- Superior CO2 performance for longer CO2 application run time
- Accurate, consistent flow delivery over the life of the cylinder

### Design

- Regulator / flowmeter combination in one compact unit
- Diaphragm style regulator with fabric reinforced neoprene diaphragm
- Back pressure compensated
- Precision needle valve, ensuring an accurate flow rate, even when exceeding 50 CFH
- External self-reseating pressure relief valve (not designed to protect downstream equipment)
- Safety overpressure burst mechanism built into flow tube for added safety
- Machined brass body & die cast housing cap
- Sintered inlet filter – bronze
- Third-party ETL listed to UL Standard 252



**WARNING:** High gas withdrawal rates on carbon dioxide may require cylinder manifolding. Consult your gas supplier.

Specifications	
Maximum Inlet	Outlet Pressure
3000 psig (CGA 580, CGA 320, 992 Models) 200 psig (CGA 032, CGA 034 Models)	Preset
Dimensions L x W x H	Weight
3 x 5.63 x 8.25 in. (76.2 x 143 x 209.6 mm)	2 lbs 8 oz (1.13 kg)

Ordering Information					
Gas Service	Part No.	Model No.	Flow Range (CFH)	Specify CGA Inlet Connection	Replacement Flow Tube
Argon, Argon/Carbon Dioxide Mix	0781-3656	HRF2435P-580	0-70 (Argon), 0-70 (CO <sub>2</sub> )	580	1015-0080
	0781-3657	HRF2435P-580 with 10 ft (3.1 m) hose			1015-0080
	0781-3658	HRF2435P-580 with hose barb			1015-0080
	0781-3661	HRF2480P-992			1015-0081
	0781-3662	HRF2435P-034 (Pipeline)			1015-0081
Carbon Dioxide, Carbon Dioxide Mix	0781-3663	HRF2435P-032 (Pipeline)	0-70 (CO <sub>2</sub> ), 0-70 (Argon)	032	1015-0081
	0781-3659	HRF2480P-320			1015-0080
Carbon Dioxide, Carbon Dioxide Mix	0781-3660	HRF2480P-320 with 10 ft (3.1 m) hose	0-70 (CO <sub>2</sub> ), 0-70 (Argon)	320	1015-0080
	0781-3664	HRF2435-580 HEL			1015-0064
Helium	0781-3664	HRF2435-580 HEL	0-200 (Helium)	580	1015-0064

Outlet Connections: 5/8"-18 RH(F), CGA 032

## DFM 150 Medium Duty

### Design/Construction

- Designed to monitor two separate processes or gas flows
- Ideal for applications where shielding gas and back purge requirements are needed
- Designed to offer convenience for the maintenance and fabrication industries
- Brass body
- Teflon seat mechanism
- Sintered inlet filter – bronze
- Music wire – spring
- Piston – brass
- Cover tube – lexan

Specifications	
Maximum Inlet	Outlet Pressure
3000 psig	25 psig (preset)
Dimensions L x W x H	Weight
5 x 5.5 x 6.5 in. (127 x 139.7 x 165.1 mm)	2 lbs 9 oz (1.16 kg)

Ordering Information							
Gas Service	Part No.	Model No.	Flow Range (SCFH)	CGA Inlet Connection	Max Inlet (psig)	HP Gauge	Replacement Flow Tube
Argon, Helium	0781-1153	DFM 150-580	5-50 (Argon), 20-150 (Helium)	580	3000	0-4000	1015-0057
Argon, Argon / Carbon Dioxide, Helium Low Pressure	0781-1206	DFM 150S	5-50 (Argon), 5-40 (Argon/CO <sub>2</sub> ) 20-150 (Helium)	1/4" NPT (F)	75	0-100	1015-0057

Outlet Connection: 5/8"-18 RH(F), CGA 032, Preset Pressure: 25 psig





## HSR & HVTS

Medium Duty, Flowmeter

### HSR Models (Single Stage)

#### Design/Construction

- Single or two stage design
- Compact in size
- Accurate regulator for gas flow
- MIG / TIG applications
- Two stage version provides extremely accurate flow rates as cylinder pressure declines
- Low surge rates – 25 psi preset

### HVTS Models (Two Stage)

#### Design/Construction

- Forged brass body and housing cap
- 2 in. (50.8 mm) high pressure gauge
- Stem type seat mechanism
- Fabric reinforced neoprene diaphragm
- External self reseating relief valve (not designed to protect downstream equipment)
- Sintered inlet filter – bronze



**WARNING:** High gas withdrawal rates on carbon dioxide may require cylinder manifolding. Consult your gas supplier.

Specifications				
Model	Maximum Inlet	Outlet Pressure	Dimensions L x W x H	Weight
HSR	3000 psig	25 psig (preset), 80 psig on CO <sub>2</sub>	4.25 x 7 x 6.25 in. (108 x 177.8 x 158.8 mm)	3 lbs 3 oz (1.45 kg)
HVTS	3000 psig	25 psig (preset), 80 psig on CO <sub>2</sub>	6.5 x 7 x 5.5 in. (165 x 177.8 x 139.7 mm)	4 lbs 10 oz (2.1 kg)

Ordering Information						
Gas Service	Part No.	Model No.	Flow Range (SCFH)	Specify CGA Inlet Connection	Replacement Flow Tube	Gas Calibrations
Nitrogen/Air	0781-3819	*HSR 2530	10-60	580	1015-0070	2
Argon/Helium	0781-3867	*HSR 2535	4-18 / 10-50	580	-	2
	0781-3775	*HVTS 2535	4-18 / 10-50	580	-	2
	0781-3871	*HSR 2537	15-65 / 40-200	580	1015-0064	2
	0781-3772	*HVTS 2537	15-65 / 40-200	580	1015-0064	2
Argon, Argon/Carbon Dioxide Mix, Helium	0781-3873	*HSR 2570	5-50	580	1015-0057	3
	0781-3869	*HSR 2570	5-40	580	1015-0057	3
	0781-3774	*HVTS 2570	20-150	580	1015-0057	3
Hydrogen	0781-3825	HSR 2533	5-40	350	1015-0070	2
Argon, Argon/Carbon Dioxide, Helium (Max Inlet – 200 psig)	0781-1245	S2570	5-50, 5-40, 20-140	034	1015-0057	3
Inert	0781-3880	HSR 1470-680	50-140-40	680	1015-0057	AR-HE-CO <sub>2</sub>

\*Outlet Connections: 5/8"-18 RH(F)

## GRF 400

Light Duty, Flowmeter

### Design/Construction

- Regulator / Flowmeter
- Single stage piston design
- Argon, Argon/CO<sub>2</sub> mix & CO<sub>2</sub> models
- 25 psig or 80 psig pre-set pressure
- Up to 50 CFH for Argon and up to 38 CFH for CO<sub>2</sub> delivery
- Available in CGA 320 & 580 inlet connections
- Optional MIG kit available with 10 ft (3.1 m) hose



Specifications	
<b>Maximum Inlet</b>	<b>Outlet Pressure</b>
3000 psig	Preset
<b>Dimensions L x W x H</b>	<b>Weight</b>
6.25 x 6 x 6.5 in. (158.8 x 152.4 x 165 mm)	2 lbs (0.91 kg)

Ordering Information	
0781-2701	GRF400-580
0781-2702	GRF400-580 with 10 ft (3.1 m) hose
0781-2703	GRF400-320
0781-2704	GRF400-320 with 10 ft (3.1 m) hose

Outlet Connection: CGA 032

## TPR 250 Purging Regulator

Light Duty

### Design/Construction

- Single stage design
- Forged brass body and housing cap
- 2 in. (50.8 mm) gauges
- Stem type seat mechanism
- Neoprene diaphragm



Specifications		
<b>Maximum Inlet</b>	<b>Dimensions L x W x H</b>	<b>Weight</b>
3000 psig	4.25 x 6.38 x 5.1 in. (108 x 162 x 130.3 mm)	2 lbs 15 oz (1.33 kg)

Ordering Information		
<b>Part No.</b>	<b>Model No.</b>	<b>Delivery Pressure (psig)</b>
0781-9133	TPR 250-125-580 CS	5-125
0781-9127	TPR 250-125-320	5-125
0781-9134	TPR 250-200-580 CS	10-250
0781-9135	TPR 250-500-580 CS	10-250

Outlet Connection: 1/4"-37° flare. CS = Clamshell Package

## MECO High Pressure

### Design/Construction

- Single-stage design
- Heavy duty applications such as oil/gas industry
- Stainless steel diaphragm
- Positive pressure yoke type regulator
- Multi-seat 4 way seat block
- Available as a preset model or with adjusting T-screw



Specifications	
<b>Maximum Inlet</b>	<b>Weight</b>
5500 psig	4 lbs 9 oz (2.2 kg)

Ordering Information				
<b>Part No.</b>	<b>Description</b>	<b>Adjusting Mechanism</b>	<b>Pressure</b>	<b>Inlet</b>
5641-8461	P Regulator 125 psi	Cap nut	125	1/4 -18 NPT
5641-8464	P Regulator 150 psi	T screw	150	1/4 -18 NPT
5641-8465	P Regulator 150 psi	Cap nut	150	1/4 -18 NPT
5641-8470	P Regulator 225 psi	T screw	225	1/4 -18 NPT
5641-8468	P Regulator 225 psi	T screw	225	1/4 -18 NPT

## Handles & Cutting Attachments

Design and Construction Features

Model 315FC (Illustrated)

**Brass Head**

For strength and durability

**"Built-In" Flashback Arrestors**

No need for accessory flash arrestors

**Control Valves With Stainless Steel Ball**

Stems have TEFLON packing for smooth gas tight operation



Patent # 5407348

**Tube With-In-A-Tube**

Designed for greater handle strength

**Forged Brass Body**

Threaded for easier service

**Heavy Ribbed Barrel**

Provides ventilation and sure grip

**"Built-In" Reverse**

Flow check valves for added operator safety  
no need for accessory check valves

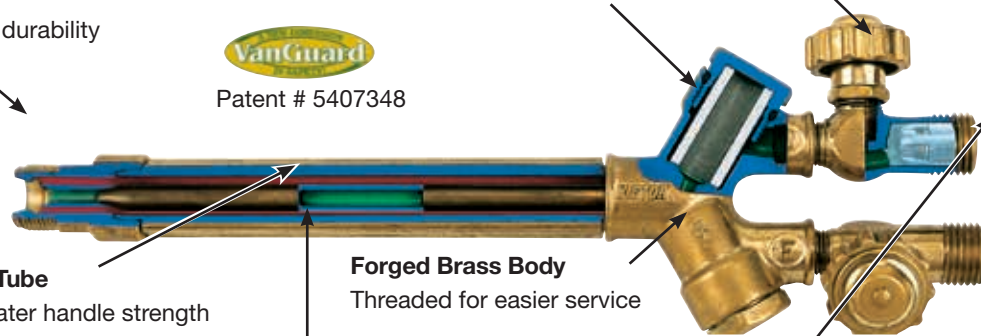

### Rugged, Efficient Design - Threaded Assembly for Ease of Service

**VICTOR TORCH HANDLES GIVE YOU TWICE THE VALUE**

Each torch handle is designed and built to withstand rugged job site conditions. In case of damage, Victor's threaded assembly design lets you replace parts quickly and economically.



**PERFORMANCE PROVEN TUBE-WITHIN-A-TUBE DESIGN**

Victor torch handles include one oxygen tube within a massive, heavy ribbed handle which also serves as the gas tube. The result is greater strength and durability plus a reduction in overall size and weight for ease of operation.

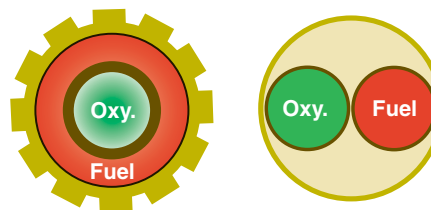

**VICTOR WITHIN-DESIGN**

Victor torch handles have greater wall thickness than other designs.

**TUBE-A-TUBE**

### Compact Balanced Attachments:

For cutting or heating. Each torch handle is designed for optimal balance and feel with its own nozzles and attachments. With proper balance of length and weight, operator fatigue is minimized.

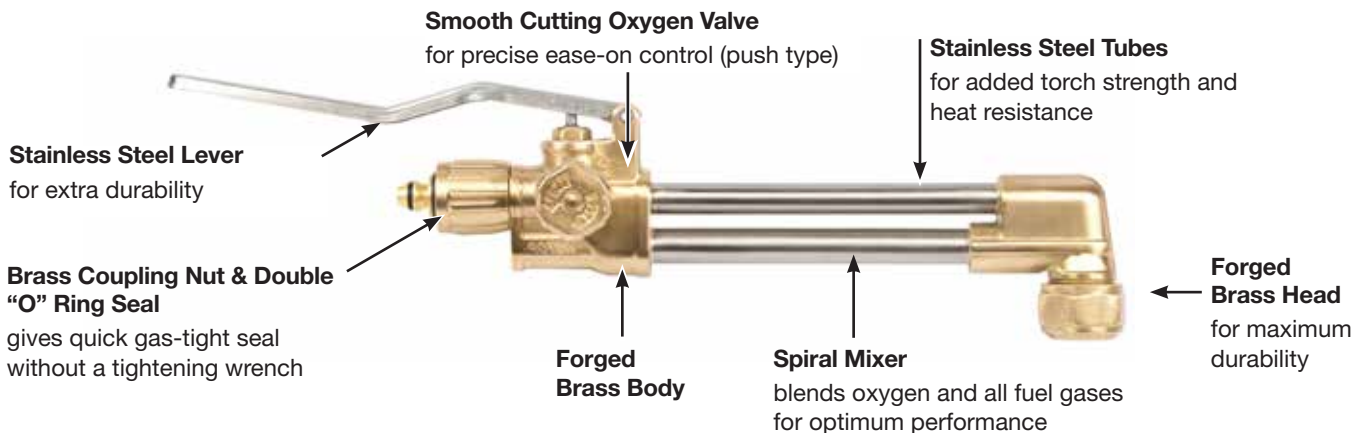

HANDLES & ATTACHMENTS

## 300 Series HD 310C Torch Handle

Victor Heavy Industry



Built tough to withstand rugged job site conditions. Threaded assembly permits economical repair if service is necessary. The HD 310C has “B” hose connections with built-in reverse flow check valves for added safety.

The HD 310C is compatible with high capacity heating nozzles and all Victor 300 Series equipment.

### Welding & Cutting Equipment:

- MFA & MFN heating nozzles
- Type 55 high capacity heating nozzles
- CA 2460 cutting attachment
- W Series welding nozzles

### Ordering Information

Part No.	Model No.	Hose Connection	Gas	Weight	Length
0382-0015	HD 310C	“B” 9/16”-18 (CGA 022 & 023)	All	28 oz	11 in. (279.4 mm)

### WARNING: USE FLASHBACK ARRESTORS

Although built to Victor’s quality and safety standards, due to the flow capacity requirements, flashback arrestors are not manufactured into this Victor heavy industry torch handle. To reduce the risk of personal injury, death and/or property damage, use sufficient capacity flashback arrestors with all Victor heavy industry torch products.

## Recommended For Best Performance:

### Flashback Arrestors

Part No.	Model	Type
<b>Oxygen: (Select one of the following)</b>		
0657-0010	*FB-0	Torch Mount
0657-0014	FB-OR	Regulator Mount
<b>Fuel: (Select one of the following)</b>		
0657-0011	*FB-F	Torch Mount
0657-0015	FB-FR	Regulator Mount
<b>Pair Packs</b>		
0656-0001	*FB-1	Oxy/Fuel Torch Mount
0656-0004	FBR-1	Oxy/Fuel Regulator Mount

\*Torch mount models also protect the hose.

## 300 Series WH 315FC+ Torch Handle

Heavy Duty



- Improved head durability, preheat control valve flow and reduced user fatigue due to improved balance
- Improved access and reparability of mixer with single nut removal
- No wrench flats on connection nut indicates hand tightening only for safer operation
- Internal connection snap ring prevents coupling nut sliding and exposure to o-rings for reduced damage
- Use with CA 2460+ cutting attachment

### Ordering Information

WH 315FC+ Welding Handle	0382-0093
--------------------------	-----------

VanGuard torch handles are offered in extra heavy duty (H 315FC) and medium duty (100FC) models, and available in Victor’s most popular system models. VanGuard torch handles also feature Victor traditional threaded assemblies for economical repair if service is necessary.

## 100 Series 100FC Torch Handle

Medium Duty



Victor torch handles are available with VanGuard™ safety features:

- Built-in flashback arrestors – no need for accessory flash arrestors
- Built-in reverse flow check valves – no need for accessory check valves
- Works with all fuel gases (pressure restrictions for different gases)

### Ordering Information

Part No.	Description	Hose Connection	Gas	Weight	Length
0382-0032	“VanGuard” Medium Duty	9/16”-18	All	14 oz	8.5 in. (215.9 mm)
0387-0011	“VanGuard” Medium Duty (Clamshell)	9/16”-18	All	14 oz	8.5 in. (215.9 mm)

## J Series - J-28 & J-40 Torch Handles

Light Duty

Victor torch handles cover the full range of welding, cutting and heating needs. Choose from patented standard models. Performance matched cutting attachments are available for each torch handle series.



J-40



J-28

### Ordering Information

Part No.	Model No.	Description	Hose Connection	Gas	Weight	Length
0382-0006	J-40	Standard, Light Duty	"A" Hose CGA 021/022	All	5.5 oz	3.75 in. (95.3 mm)
0382-0127	J-28	Light Duty	"A" Hose CGA 021/022	All	8.5 oz	6 in. (152.4 mm)

J-40 handle does not have check valves or flashback arrestors included. J-28 handle includes accessory reverse flow check valves for regulator use

HANDLES & ATTACHMENTS

## CA 2460+ Cutting Attachment

Heavy Duty



- Improved head durability, preheat control valve flow and reduced user fatigue due to improved balance
- Improved access and reparability of mixer with single nut removal
- Superior cutting oxygen valve with improved Feathering/Ease-On control
- No wrench flats on connection nut indicates hand tightening only for safer operation
- Internal connection snap ring prevents coupling nut sliding and exposure to o-rings for reduced damage
- Use with WH 315FC+ torch handle

### Ordering Information

CA 2460+ Cutting Attachment, 90 Deg	0381-1928
CA 2460+ Cutting Attachment, 75 Deg	0381-1930
CA 2460+ Cutting Attachment, 180 Deg	0381-1932
Plus Torch Replacement Pack - WH 315FC+/CA 2460+ 90 deg	0381-1937

## CA 1350 Cutting Attachment

Medium Duty

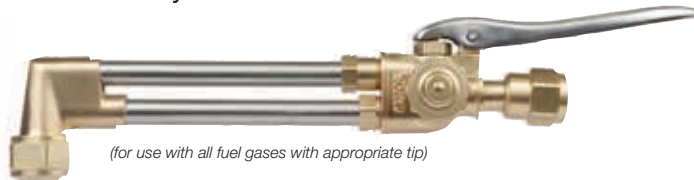

(for use with all fuel gases with appropriate tip)

### Performance matched for each torch handle series.

- Forged brass head
- Spiral mixer blends oxygen and fuel
- Smooth cutting valve (pull type)
- Stainless steel tubes
- Brass coupling nut and double "O" ring seal gives quick gas-tight seal tightening with out wrench
- Length 8 in. (203.2 mm)
- Weight 13 oz (0.37 kg)

### Ordering Information

Part No.	Model No.	Cutting Range	Tip Series	Head Angle
0381-0418	CA 1350	6 in. (152.4 mm)	3	90°
0387-0005	CA 1350 CS	6 in. (152.4 mm)	3	90°
0381-0420	CA 1351	6 in. (152.4 mm)	3	75°
0381-0421	CA 1352	6 in. (152.4 mm)	3	180°

CS = Clamshell Package

## CA 1260 Cutting Attachment

Light Duty



Performance matched for each torch handle series.

- Forged brass head
- Spiral mixer blends oxygen & fuel
- Smooth cutting valve (pull type)
- Stainless steel tubes
- Brass coupling nut & double "O" ring seal gives quick gas-tight seal tightening without wrench
- Length 8 in. (203.2 mm)
- Weight 13 oz (0.37 kg)

Ordering Information				
Part No.	Model No.	Cutting Range	Tip Series	Head Angle
0381-0162	CA 1260	3 in. (76.2 mm)	3	90°
0387-0003	CA 1260 CS	3 in. (76.2 mm)	3	90°

CS = Clamshell Package

## WH370 / WH270 Torch Handle

Medium Duty



- Forged brass body for durability
- Torch handle has built-in check valves and flashback arrestors for safety
- WH 370 fits CA 370-V / WH 270 fits CA 270-V

Ordering Information			
Part No.	Model No.	Hose Connection	Gas
0387-2750	WH370 Single	"B" 9/16"-18 (CGA 022 & 023)	All
0387-2700	WH270 Single	"B" 9/16"-18 (CGA 022 & 023)	All

## CA 370-V / CA 270-V Cutting Attachment

Medium Duty

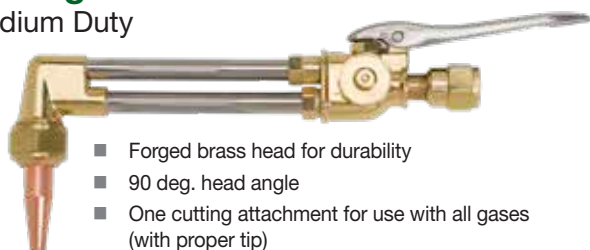

- Forged brass head for durability
- 90 deg. head angle
- One cutting attachment for use with all gases (with proper tip)
- CA 370-V fits WH 370 / CA 270-V fits WH 270

Ordering Information				
Part No.	Model No.	Cutting Range	Tip Series	Head Angle
0387-2650	CA 370-V Single	5 in. (127 mm)	1	90°
0387-2600	CA 270-V Single	5 in. (127 mm)	3	90°
0387-0206	CA 370-V / WH370 Combo	6 in. (152 mm)	1	90°
0387-0200	CA 270-V / WH270 Combo	6 in. (152 mm)	3	90°

## 400 Series WH 411C Torch Handle

Heavy Duty



- Accepts CA411-3 & CA411-1 Cutting Attachments, W Series Welding Tips and MFA/MFN/Type55 Heating Assemblies
- 5 Year Warranty

Special designed alloy material:

- 3x the tensile strength of Brass
- Ergonomic, textured, precision contoured handle is designed to reduce operator fatigue and provide better grip
- Durable to withstand tough use and prevention of dents and scratches

Intuitive knobs:

- Color-coded
- Clearly marked lettering with increase/decrease label
- Understandable in any language

Ordering Information			
Part No.	Model No.	Hose Connection	Gas
0382-0355	WH 411C	"B" 9/16"-18 (CGA 022 & 023)	All

## CA 411-1 Cutting Attachment

Heavy Duty

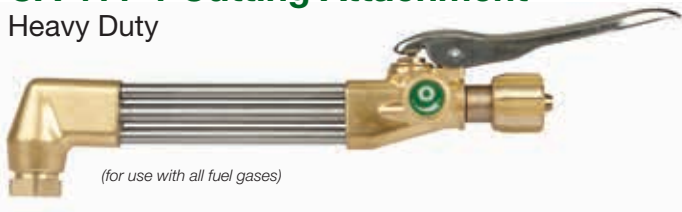

## CA 411-3 Cutting Attachment

Medium Duty

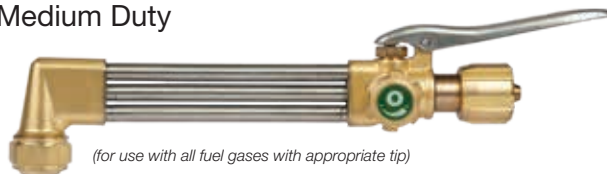

Performance matched for each torch handle series.

- Efficient Universal Spiral Head Mixer
- 1 Cutting Attachment for All Fuel Gases
- Redesigned inlet nut increases grip for Hand Tightening
- Inline stainless tubes for better visibility
- Improved Stainless Lever provides increased comfort and reduced operator hand fatigue
- 5 Year Warranty

Ordering Information				
Part No.	Model No.	Cutting Range	Tip Series	Head Angle
0381-1940	CA411-1	6 in. (152.4 mm)	1	90°
0381-1939	CA411-3	5 in. (127.0 mm)	3	90°

Heavy and medium duty cutting attachments for use with acetylene, propane, butane, liquid air fuel gas, natural gas (2 PSI & above) and propylene. Cutting attachment accepts all Victor Style Tips.

HANDLES & ATTACHMENTS

## Exclusive "OPTIMIZED" nozzles with a large choice of types and sizes, plus uniformity of tip orifice and size for all series

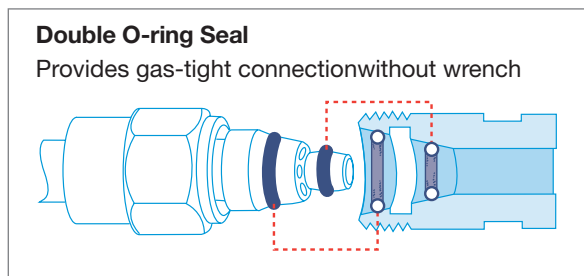
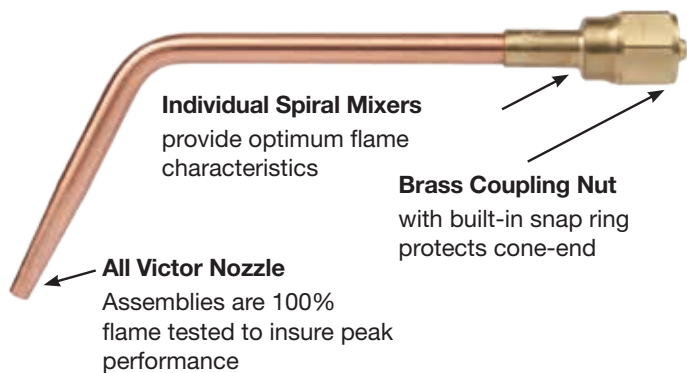

Victor offers a complete range of nozzles, tips and elbows with a size for every application including: welding, brazing, heating, descaling, hard facing, flame priming, etc.

### Nozzles Designed for "Optimum" Performance

Each complete nozzle has its own built-in spiral mixer, individually designed for each tip size and flame characteristic. Each nozzle is individually swaged to insure proper alignment for uniform flame, sizing and free-flow contour.

### Orifice Sizes are Common for All Series

Regardless of nozzle series (W, W-1, W-J), flame characteristic or fuel gas used. The uniformity of orifice sizes simplifies nozzle selection, eliminates chances of ordering and wrong size when changing from one type of nozzle to another.

Flame orifice size the same for all nozzle series

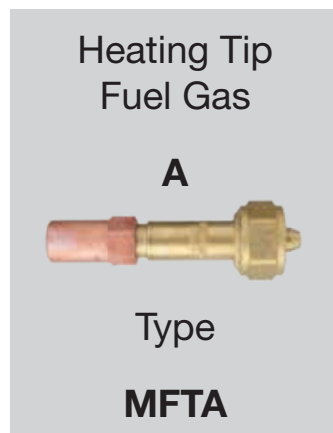
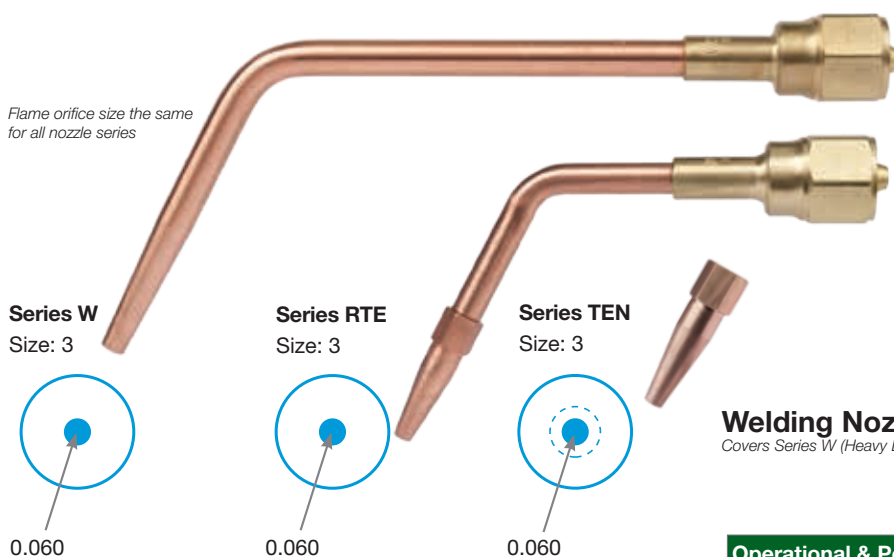

NOZZLES

### Welding Nozzle Operational Data/Acetylene

Covers Series W (Heavy Duty), W-1 (Medium Duty) And W-J (Light Duty) Series

Oxy-Acetylene & Oxy-Hydrogen				
Application	Torch Series	Nozzle Type	Available Sizes	Illustration
General purpose welding & heating. Uses replaceable tip ends. Flame characteristic – Long cone	315FC H 315FC	RTE	000-6, 8, 10	<p>65°</p> <p>Sizes: 000-6, 8 (Length 4.5") Size: 10 (Length 14")</p>
	315FC 100FC	W W-1	000-8, 10 000-7	
General purpose welding & preheating. Swaged one-piece copper elbow. Flame characteristic – Long cone	J-28 J-40	W-J	000-4	<p>65°</p> <p>Sizes: 000-8 (Length 4.5") Size: 10 (Length 14")</p>

Operational & Performance Data					
Metal Thickness	Tip Size	Drill Size	Oxygen (psig)	Acetylene (psig)	Acetylene (Scfh)
1/32 in. (0.8 mm)	000	75 (0.022)	3/5	3/5	1/2
3/64 in. (1.2 mm)	00	70 (0.028)	3/5	3/5	1.5/3
5/64 in. (1.9 mm)	0	65 (0.035)	3/5	3/5	2/4
3/32 in. (2.4 mm)	1	60 (0.040)	3/5	3/5	3/6
1/8 in. (3.2 mm)	2	56 (0.046)	3/5	3/5	5/10
3/16 in. (4.8 mm)	3	53 (0.060)	4/7	3/6	8/18
1/4 in. (6.4 mm)	4	49 (0.073)	5/10	4/7	10/25
1/2 in. (12.7 mm)	5	43 (0.089)	6/12	5/8	15/35
3/4 in. (19.0 mm)	6	36 (0.106)	7/14	6/9	25/45
1 1/4 in. (32.0 mm)	7	30 (0.128)	8/16	8/10	30/60
2 in. (51.0 mm)	8	29 (0.136)	10/19	9/12	35/75
3 in. (76.2 mm)	10	27 (0.144)	12/24	12/15	50/100

**WARNING:** At no time should the withdrawal rate of an individual acetylene cylinder exceed 1/7 of the cylinder contents per hour. If additional flow capacity is required use an acetylene manifold system of sufficient size to supply the necessary volume.

Oxygen consumption (SCFH) is 1.1 times the acetylene under neutral flame conditions.

## Type 55/55-1 Multi-Flame Heating Nozzles

Use with 300, HD 310C Series Torch Handles  
Victor Heavy Industry

The Type 55 Series multi-flame heating nozzles feature a raised center point on the head to prevent bumping the plate and compressing the flame. The center point and improved mixer design combine to provide greater resistance to sustained backfire and improved flow performance. Type 55s can be ordered as a complete assembly or as individual components.

- High capacity heating head for heat treating, straightening, and priming
- LP Gases

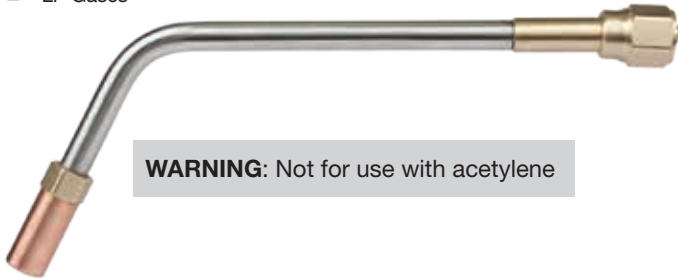

**WARNING:** Not for use with acetylene

Ordering Information				
Part No.	Type	Available size	Available Length	Series
0323-0326	55	20*	28 in. (711.2 mm)	HD 310C
0323-0325	55	15*	28 in. (711.2 mm)	HD 310C
0323-0324	55	10*	28 in. (711.2 mm)	HD 310C
0323-0328	55	8	11 in. (279.4 mm)	HD 310C/300
0323-0327	55	6	11 in. (279.4 mm)	300
0324-0188	55-1	6	11 in. (279.4 mm)	100

\*Size 10, 15 and 20 Type 55 heating nozzles must be used with HD 310C torch handle and 3/8 in. (9.5 mm) hose.

### Type 55 – for use with Propylene based fuel gases, Methane, Propane, Butane, & pressurized Natural Gas

Tip Size	Oxygen Pressure (psig)	Fuel Pressure (psig)	Oxygen Consumption (SCFH)	Fuel Consumption (SCFH)	BTU/h
20	100/150	30/50	900/1150	400/500	See Chart
15	90/120	20/35	600/800	250/350	
10	70/100	15/25	356/460	150/200	
8	70/85	15/25	220	85	
6	70/80	15/20	160	65	

#### BTU Per Hour

To approximate gross BTU output, multiply flow rate by BTU value listed below:

Propane	2498
Natural Gas	1000
Butane	3374
Propylene	2371

#### Warning:

- Use flashback arrestors
- Although built to Victor's quality and safety standards, due to the cutting capacity and/or design of each torch, flashback arrestors are not manufactured into the 310C Series Victor heavy industry torches
- To reduce the risk of personal injury, death and/or property damage, use sufficient capacity flashback arrestors with all Victor heavy industry torch products
- Alternative fuel gas only refers to propane, natural gas, propylene gases. Acetylene, hydrogen and gasoline are NOT included as an alternative gas

## Type 55 Components 300 Series

Type 55 Series multi-flames are available as components. Threaded elbows give you the flexibility to easily service or extend the length of the nozzles. Use the special extensions adapter to extend the tip tube to the required length.



**0328-0012 & 0328-0013**  
Mixer and Nut Assembly

Ordering Information					
Part No.	Available Size	Application/Description	Available Length	Available Angles	Series
0311-0232	20*	Multi-Flame Heads	–	–	HD 310C
0311-0231	15*	Multi-Flame Heads	–	–	HD 310C
0311-0230	10*	Multi-Flame Heads	–	–	HD 310C
0311-0241	8	Multi-Flame Heads	–	–	HD 310C/300
0311-0240	6	Multi-Flame Heads	–	–	300
0304-0002	–	Multi-Flame Elbows	14 in. (355.6 mm)	65°	HD 310C/300
0304-0095	–	Multi-Flame Elbows	16 in. (406.4 mm)	180°	HD 310C/300
0304-0011	–	Multi-Flame Elbows	26 in. (660.4 mm)	65°	HD 310C/300
0328-0012	Mixer and nut assembly, for use with pressures from 10 psig and up.				HD 310C/300
0328-0013	Mixer and nut assembly, for use with pressures from 2 - 10 psig.				HD 310C/300
0312-0064	Extension Adapter - Thread specifications: 1/4"- 18 NPT(F) X 1/2"- 27 UNS(F)"				HD 310C/300

\*Size 10, 15 and 20 Type 55 heating nozzles must be used with HD 310C torch handle and 3/8 in. (9.5 mm) hose.



## MFN/MFN-1 Heating Nozzles

Use with 100, 300 & HD310C Series Torch Handles  
Victor Heavy Industry

- Multi-flame heating head for preheating, priming and straightening
- LP Gases

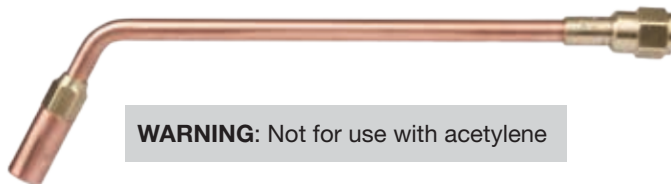

**WARNING:** Not for use with acetylene

Ordering Information					
Part No.	Type	Size	Tip End Replacement	Length	Series
0323-0303	MFN	12*	–	17.5" (444.5 mm)	HD 310C
0323-0304	MFN	15*	–	17.5" (444.5 mm)	HD 310C
0323-0305	MFN	20*	–	17.5" (444.5 mm)	HD 310C
0323-0292	MFN	8	–	12.0" (304.8 mm)	300
0323-0302	MFN	10	–	17.5" (444.5 mm)	300
0324-0117	MFN-1	6	0311-0611	12.0" (304.8 mm)	100
0324-0118	MFN-1	8	0311-0612	12.0" (304.8 mm)	100

\*Size 12, 15 and 20 MFN heating nozzles must be used with HD 310C torch handle and 3/8 in. (9.5 mm) hose.

### Type MFN, MFN-1 – for use with Propane & Natural Gas

Tip Size	Oxygen Pressure (psig)	Fuel Pressure (psig)	Oxygen Consumption (SCFH)	Fuel Consumption (SCFH)	BTU Per Hour
6	8/20	2/10	20/80	5.5/20	See Chart
8	10/20	10/15	40/140	10/35	
10	10/30	12/20	80/320	20/80	
12	30/125	15/25	120/640	30/160	
15	30/125	15/25	200/800	50/200	
20	40/135	15/25	300/1000	75/250	

#### BTU Per Hour

To approximate gross BTU output, multiply flow rate by BTU value listed below:

Propane	2498
Natural Gas	1000
Butane	3374
Propylene	2371

#### Warning:

- Use flashback arrestors
- Although built to Victor's quality and safety standards, due to the cutting capacity and/or design of each torch, flashback arrestors are not manufactured into the 310C Series Victor heavy industry torches
- To reduce the risk of personal injury, death and/or property damage, use sufficient capacity flashback arrestors with all Victor heavy industry torch products
- Alternative fuel gas only refers to propane, natural gas, propylene gases. Acetylene, hydrogen and gasoline are NOT included as an alternative gas

## MFA/MFA-1 Heating Nozzles

Use with J, 100, 300 & HD310C Series Torch Handles  
Victor Heavy Industry

- Multi-flame heating head for heat treating, straightening and priming
- Acetylene / Hydrogen



Ordering Information						
Part No. Boxed	Part No. Clamshell	Type	Size	Tip End Replacement	Length	Series
0323-0261	0387-0064	MFA	12	0311-0540	17.5" (444.5 mm)	HD 310C
0323-0262	0387-0065	MFA	15	–	17.5" (444.5 mm)	HD 310C
0323-0250	0387-0060	MFA	4	0311-0536	12.0" (304.8 mm)	300
0323-0251	0387-0061	MFA	6	0311-0537	12.0" (304.8 mm)	300
0323-0252	0387-0062	MFA	8	0311-0538	12.0" (304.8 mm)	300
0323-0260	0387-0063	MFA	10	0311-0539*	12.0" (304.8 mm)	300
0324-0108	–	MFA-1	2	0311-0598	12.0" (304.8 mm)	100
0324-0109	0387-0071	MFA-1	4	0311-0599	12.0" (304.8 mm)	100
0324-0110	0387-0072	MFA-1	6	0311-0600	12.0" (304.8 mm)	100
0324-0111	0387-0073	MFA-1	8	0311-0601	12.0" (304.8 mm)	100
0325-0104	–	MFA-J	2	–	–	J
0325-0105	–	MFA-J	4	–	–	J
0325-0106	0387-0077	MFA-J	6	–	–	J

\*Size 12, 20 and MFA heating nozzles must be used with HD 310C torch handle and 3/8 in. (9.5 mm) hose.

### Type MFA, MFA-1 – for use with Acetylene

Tip Size	Oxygen Pressure (psig)	Acetylene Pressure (psig)	Oxygen Consumption (SCFH)	Acetylene Consumption (SCFH)	BTU Per Hour
2	4/8	4/8	3/10	3/9	See Chart
4	8/12	6/10	7/22	6/20	
6	10/15	8/12	15/44	14/40	
8	20/30	10/15	33/88	30/80	
10	30/40	12/15	44/110	40/100	
12	50/60	12/15	66/165	60/150	
15	50/60	12/15	99/244	90/220	

#### BTU Per Hour

To approximate gross BTU output, multiply flow rate by BTU value listed below:

Acetylene	1470
Methane	1000

#### Warning:

At no time should the withdrawal rate of an individual acetylene cylinder exceed 1/7 of the cylinder contents per hour. If additional flow capacity is required use an acetylene manifold system of sufficient size to supply the necessary volume.

## Series 1 Heating Tips Type MFTA – Acetylene



For preheating before welding, descaling and paint burning, etc.



Ordering Information	
Size	Part No.
6	0330-0527
8	0330-0528
*10	0330-0523
*12	0330-0524

*\*Use 3/8 in. (9.5 m) hose and straight torch  
Required pressures: 12/15 Acetylene; 70/80 psig Oxygen  
Size 8 is maximum size for use with cutting attachments*

## Type MFTN – LP (Propane/Natural Gas)



For preheating before welding, descaling and paint burning, etc.



Ordering Information	
Size	Part No.
10	0330-0521
12	0330-0522

*Not for use with cutting attachments*

## CHT Adaptor

- Concentrated Heating Tip Adaptor for straightening, bending and forming of plate
- For Use with Alternate Fuels
- Use with HPP or HPN size 5 cutting tip, multi-flame elbow, or mixer and nut assembly



Ordering Information	
CHT Adaptor	0312-0089

## Welding Nozzles W Series

For use with  
300 Series torch handles



### W-1 Series

For use with  
100 Series torch handles



### W-J Series

For use with  
J Series torch handles



- General purpose welding & preheating
- Fuel gas usage - acetylene, hydrogen
- 65° tip angle
- Long cone flame
- One piece copper elbow tip

Ordering Information				
Model	Size	Part No.		Series
		Boxed	Clamshell	
W	000	0323-0110	–	300
	00	0323-0111	0387-0019	300
	0	0323-0112	0387-0020	300
	1	0323-0120	0387-0021	300
	2	0323-0121	0387-0022	300
	3	0323-0122	0387-0023	300
	4	0323-0130	0387-0024	300
	5	0323-0131	–	300
	6	0323-0132	–	300
	7	0323-0140	–	300
W-1	000	0324-0068	0387-0028	100
	00	0324-0069	0387-0029	100
	0	0324-0070	0387-0030	100
	1	0324-0071	0387-0031	100
	2	0324-0072	0387-0032	100
	3	0324-0073	0387-0033	100
	4	0324-0074	0387-0034	100
	5	0324-0075	–	100
	6	0324-0076	–	100
	7	0325-0081	–	J
W-J	000	0325-0081	–	J
	00	0325-0082	0387-0039	J
	0	0325-0083	0387-0040	J
	1	0325-0084	0387-0041	J
	2	0325-0085	0387-0042	J
	3	0325-0086	0387-0043	J
	5	0325-0088	–	J
6	0325-0089	–	J	
7	0325-0090	–	J	

## Elbow Tips

### ET Series

For use with  
300 Series torch handles



### ET-1 Series

For use with  
100 Series torch handles



### ET-J Series

For use with  
J Series torch handles



- One piece copper elbow tip
- Long cone flame
- Fuel gas usage - acetylene, hydrogen

Ordering Information			
Model	Size	Part No.	Series
ET	000	0311-0055	300
	00	0311-0056	300
	0	0311-0057	300
	1	0311-0058	300
	2	0311-0059	300
	3	0311-0572	300
	4	0311-0573	300
	5	0311-0574	300
	6	0311-0575	300
	7	0311-0576	300
8	0311-0577	300	
10	0311-0073	300	
ET-1	3	0311-0345	100
	4	0311-0340	100
	5	0311-0602	100
	6	0311-0603	100
ET-J	000	0311-0123	J
	00	0311-0124	J
	0	0311-0125	J
	1	0311-0126	J
	2	0311-0127	J
	3	0311-0128	J
4	0311-0129	J	

## UM Series Universal Mixers

Oxy-Acetylene universal mixers used when exact performance & Individual nozzles are not needed.



Ordering Information					
Type	Part No.	Fuel Gas Usage	Elbow Tips	Length	Series
4-UM-1	0328-0005	Oxy-Acetylene	000-2 ET, 3 ET-1, 4 ET-1	1.75" (44.5 mm)	100
7-UM-1	0328-0009	Oxy-Acetylene	5 ET-1, 6 ET-1	1.75" (44.5 mm)	100

## RTE Series Replaceable Tip Ends

For use with 300 Series torch handles

- General purpose welding & preheating
- Uses replacement tip ends (TE Series)
- 65° tip angle

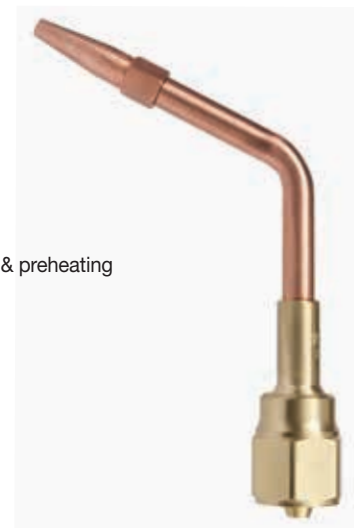

### RTEN Series

- General purpose brazing & preheating
- Long cone flame
- Uses TEN tip ends

Ordering Information				
Model	Size	Part No.	Fuel Gas Usage	Series
RTE	00	0323-0307	Acetylene, Hydrogen	300
	0	0323-0308	Acetylene, Hydrogen	300
	1	0323-0309	Acetylene, Hydrogen	300
	2	0323-0310	Acetylene, Hydrogen	300
	3	0323-0311	Acetylene, Hydrogen	300
	4	0323-0312	Acetylene, Hydrogen	300
	5	0323-0313	Acetylene, Hydrogen	300
	6	0323-0314	Acetylene, Hydrogen	300
	8	0323-0316	Acetylene, Hydrogen	300
	10	0323-0317	Acetylene, Hydrogen	300
RTEN	6	0323-0284	Natural Gas, Propane	300

## FE Series Flexible Elbow

- Flexible elbow for special welding, brazing, and heating needs
- Multi-fuel gas service
- Uses replaceable tip ends
- Thread: 5/16"-27



### Ordering Information

Type	Part No.	Fuel Gas Usage	Tip End Replacements	Length	Series
FE	0323-0191	Multi-Gas Fuel Service	TE, TEN, TEMFA, TEMFN, TEMF	11.5 in. (292.1 mm)	300
FE-1	0324-0066	Multi-Gas Fuel Service	TE, TEN, TEMFA, TEMFN, TEMF	11.5 in. (292.1 mm)	100
FE-J	0325-0102	Multi-Gas Fuel Service	TE, TEN, TEMFA, TEMFN, TEMF	11.5 in. (292.1 mm)	J

## UN Series Universal Nozzle

- Standard bend nozzle for welding, brazing and heating
- Uses replaceable tip ends
- 65° tip angle
- Thread: 5/16"-27



### Ordering Information

Type	Part No.	Fuel Gas Usage	Tip End Replacements	Length	Series
UN	0323-0242	Multi-Gas Fuel Service	TE, TEN, TEMFA, TEMFN, TEMF	5 in. (127.0 mm)	300
UN-1	0324-0094	Multi-Gas Fuel Service	TE, TEN, TEMFA, TEMFN, TEMF	5 in. (127.0 mm)	100
UN-J	0325-0101	Multi-Gas Fuel Service	TE, TEN, TEMFA, TEMFN, TEMF	5 in. (127.0 mm)	J

## DFE Series Dual Flexible Elbows

- Dual flexible elbow nozzle assembly for special welding, brazing and heating
- Uses replaceable tip ends
- Thread: 5/16"-27

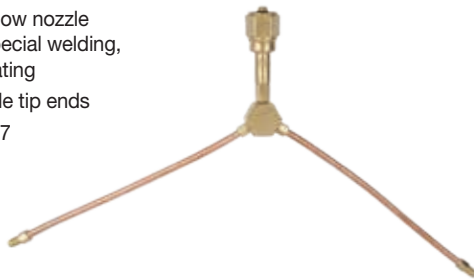

### Ordering Information

Type	Part No.	Fuel Gas Usage	Tip End Replacements	Series
DFE	0323-0192	Multi-Gas Fuel Service	TE, TEN, TEMFA, TEMFN, TEMF	300
DFE-1	0324-0092	Multi-Gas Fuel Service	TE, TEN, TEMFA, TEMFN, TEMF	100
DFE-J	0325-0108	Multi-Gas Fuel Service	TE, TEN, TEMFA, TEMFN, TEMF	J

## Replaceable Tip Ends

TE, TEN, TEMFA, TEMFN & TEMF 300, 100 & J Series

### For All Nozzles Using Replaceable Tip Ends

Type	Application, Description	Fuel Gas	Illustration
TE	Welding, brazing Flame – long Cone One piece	Acetylene	
TEN	Brazing, silver brazing Flame – long Cone One piece	Natural Gas, Propane	
TEMFA	Brazing, silver brazing, heating Flame – multi-flame One piece	Acetylene	
TEMFN	Brazing, silver brazing, heating Flame – multi-flame One piece	All Fuel Gases Except Acetylene	
TEMF	Brazing, soldering, heating Flame – multi-flame Two piece	All Fuel Gases Except Acetylene	

### Tip Size, Length, Thread Size

Type	Size(s)	Length	Thread	Part No.
TE	000	1.5 in. (38.1 mm)	5/16-27	0311-0471
	00	1.5 in. (38.1 mm)	5/16-27	0311-0472
	0	1.5 in. (38.1 mm)	5/16-27	0311-0473
	1	1.5 in. (38.1 mm)	5/16-27	0311-0474
	2	1.5 in. (38.1 mm)	5/16-27	0311-0475
	3	1.63 in. (41.4 mm)	5/16-27	0311-0587
	4	1.88 in. (47.8 mm)	5/16-27	0311-0588
	5	2 in. (50.8 mm)	5/16-27	0311-0589
	6	2.25 in. (57.2 mm)	0.393-27	*0311-0590
	8	2.75" (69.9 mm)	0.393-27	*0311-0592
TEN	10	3" (76.2 mm)	0.440-27	*0311-0593
	0	1.5 in. (38.1 mm)	5/16-27	0311-0483
	2	1.5 in. (38.1 mm)	5/16-27	0311-0485
	3	1.63 in. (41.4 mm)	5/16-27	0311-0486
	4	1.88 in. (47.8 mm)	5/16-27	0311-0487
	5	2 in. (50.8 mm)	5/16"-27	0311-0488
TEMFA	6	2.25 in. (57.2 mm)	0.393-27	*0311-0585
	1	1.5 in. (38.1 mm)	5/16-27	0311-0215
	2	1.5 in. (38.1 mm)	5/16-27	0311-0216
	3	1.5 in. (38.1 mm)	5/16-27	0311-0217
	4	1.5 in. (38.1 mm)	5/16-27	0311-0218
TEMFN	5	1.5 in. (38.1 mm)	5/16-27	0311-0219
	3	1.5 in. (38.1 mm)	5/16-27	0311-0306
	4	1.5 in. (38.1 mm)	5/16-27	0311-0307
TEMF	5	1.5 in. (38.1 mm)	5/16-27	0311-0308
	6	1.5 in. (38.1 mm)	5/16-27	0311-0676
	7	1.5 in. (38.1 mm)	5/16-27	0311-0677
	8	1.5 in. (38.1 mm)	5/16-27	0311-0678
	9	1.5 in. (38.1 mm)	5/16-27	0311-0679
	10	1.5 in. (38.1 mm)	5/16-27	0311-0680

Adapter for tip ends to fit tip tube: 5/16"-27(F) x 1/8"-27(M) 0312-0071 \*Fit nozzles RTE only

## Victor “Universal Torches”

They combine the spiral and injector mixer principles. The result is a high performance torch that operates on any fuel gas.

Universal torch cutting capacity from 1/8 in. (3.2 mm) to 8 in. (203.2 mm).

*Model ST 2600FC Illustrated  
U.S. Patent #5407348*

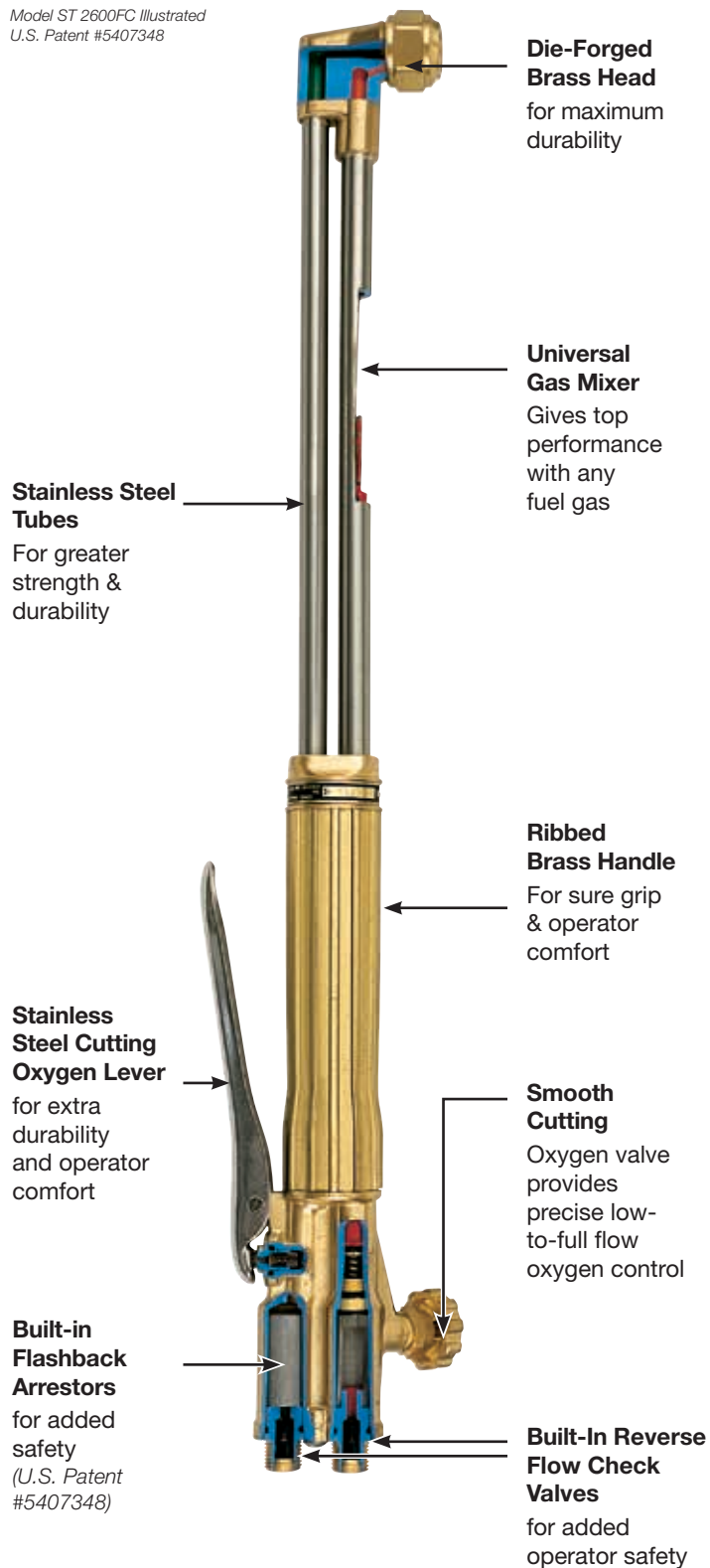

The high capacity straight torches in this section are designed for heavy cutting applications found in such industries as scrapping, demolition and foundries.

Although built to Victor’s quality and safety standards, due to the cutting capacity and/or design of each torch, flashback arrestors are not manufactured into these Victor Heavy Industry torches.

**WARNING:** Use add-on flashback arrestors

To reduce the risk of personal injury, death and/or property damage, use sufficient capacity flashback arrestors with all Victor Heavy Industry torch products.

Alternative fuel gas only refers to propane, natural gas, propylene gases. **Acetylene, hydrogen and gasoline** are **NOT** included as an alternative gas.

**Do you need special length torches?  
If you don't see what you need contact  
Technical Services**

**1-800-569-0547**

**Reference Heavy Industry Products**  
Victor welcomes your request for special length torches.

**Built-in Reverse flow check valve**  
for added operator safety

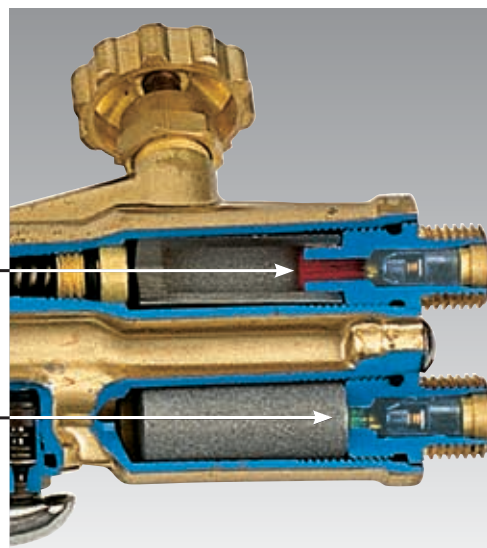

**Most Victor Hand Cutting Torches**  
are equipped with built-in reverse flow check valves and flash arrestors

## HC 1500C

Victor Heavy Industry

**WARNING:** Use add-on flashback arrestors.  
Not for use with acetylene.

### Three hose scrap straight cutting torches



The HC 1500C Series is a three hose design with a 48 in. cutting capacity and is ideal for heavy steel, scrap cutting. The torch has "C" 7/16"-14 (RH) oxygen connection and standard "B" 9/16"-18 oxygen/fuel preheat connections.

The HC 1500C is manufactured without built-in flashback arrestors. Reverse flow check valves are installed at the inlet connection.

- Three hose connection
- Extra heavy duty
- Cutting capacity 48 in. (121.9 cm)
- Length: 56 in. (142.2 cm)
- For use with propane or natural gas
- Not for use with acetylene
- Uses Series 2-285N (two piece) cutting tips
- Special lengths available on request

Ordering Information							
Part No.	Model No.	Head Angle	Hose Connection Preheat	Hose Connection Cutting (Oxygen)	Length	Fuel Gas	Cutting Capacity
0381-0444	HC 1500C	180°	"B" 9/16" -18 LH & RH	"C" 7/8 in. -14 RH	48 in. (121.9 cm)	Natural Gas & Propane	48 in. (121.9 cm)
0381-0509	HC 1500C	90°	"B" 9/16" -18 LH & RH	"C" 7/8 in. -14 RH	84 in. (213.4 cm)	Natural Gas & Propane	48 in. (121.9 cm)
0381-0515	HC 1500C	90°	"B" 9/16" -18 LH & RH	"C" 7/8 in. -14 RH	96 in. (243.8 cm)	Natural Gas & Propane	48 in. (121.9 cm)

Uses Series 2-285N (two piece) cutting tips. See chart below

### For best performance, use the following recommended equipment:

#### Flashback Arrestors

Gas Service	Part No.	Model	Type
Cutting Oxygen	Not required		
Preheat Oxygen	0657-0076	*FBHC-O	Torch Mount
	0657-0078	FBHC-OR	Regulator Mount

\*Torch mount models also protect the hose

#### Hoses

(Contact local distributor for hose information)

- Cutting Oxygen:
  - 1/2 in. I.D. with "C" hose (7/16"-14 RH) connections
  - Use T-grade or RM-grade hose
- Preheat Oxygen:
  - 3/8 in. I.D. with "B" hose (9/16"-18 RH) connections
  - Use T-grade hose
- Preheat Fuel:
  - 3/8 in. I.D. with "B" hose (9/16"-18 LH) connections
  - Use T-grade hose

#### Regulators

- Cutting Oxygen:
  - ELC4, ESS7-125-540, SR 700D- 540, or S or L 700D-500/750 line supply
- Preheat Oxygen:
  - SR 450D-540, or S or L 700D-500/750 line supply
- Preheat Fuel:
  - SR 461D-510, or S or L 711D-500/750 line supply

#### Regulators

##### 2-285N Two Piece Tips – for use with HC 1500C torches

Part No.	Model No.	Size	Cutting Range	Cutting Orifice Dia.	*Cutting Oxygen (psig)	Cutting Oxygen (SCFH)	Preheat Oxygen (psig)	Preheat Oxygen (SCFH)	*Fuel (psig)	Fuel (SCFH)
0336-0041	2-285N	0.25	14" to 20"	0.25	25/45	1500/2400	25/50	250/400	15/20	60/120
0336-0042	2-285N	0.312	20" to 26"	0.312	25/45	2300/3500	25/50	250/400	15/20	60/120
0336-0043	2-285N	0.375	26" to 34"	0.375	20/40	2300/3900	25/50	250/400	15/20	60/120
0336-0044	2-285N	0.437	34" Over	0.437	20/40	2400/4500	25/50	250/400	15/20	60/120

\*Pressure is measured at back of torch when torch is flowing

Oxygen Consumption:

1. Adequate volume required. Dual supplies recommended when using cylinders.
2. When operating from bulk oxygen supply it is recommended that separate oxygen drop stations are used.

## HC 1200C Series

Victor Heavy Industry

### High Capacity/Heavy Duty



The HC 1200C Series torches are high capacity, heavy duty cutting torches that have a cutting capacity up to 18 in. (45.7 cm). These torches are used in a wide variety of heavy industrial applications that include scrapping and demolition.

The HC 1200C is manufactured without built-in flashback arrestors. Revers flow check valves are installed at the inlet connection.

- For use with any fuel gas, 2 psig and above
- Universal mixer
- Cutting capacity 18 in. (45.7 cm)
- Standard Lengths: 21 in. (53.3 cm) - 96 in. (243.8 cm)
- Uses Series 1 cutting tips
- "B" 9/16"-18 hose connections
- Extra length models available upon request
- Lock down lever kit available. Part number: 0307-0062

Ordering Information			
Torch Part No.	Model No.	Head Angle	Length
0381-1402	HC 1200C	90°	21 in. (53.3 cm)
0381-1403	HC 1201C	75°	21 in. (53.3 cm)
0381-1404	HC 1202C	180°	21 in. (53.3 cm)
0381-1405	HC 1230C	90°	36 in. (91.4 cm)
0381-1406	HC 1231C	75°	36 in. (91.4 cm)
0381-1407	HC 1232C	180°	36 in. (91.4 cm)
0381-1408	HC 1250C	90°	48 in. (121.9 cm)
0381-1432	HC 1250LC*	90°	48 in. (121.9 cm)
0381-1409	HC 1251C	75°	48 in. (121.9 cm)
0381-1415	HC 1252C	180°	48 in. (121.9 cm)
0381-1419	HC 1262C	180°	60 in. (152.4 cm)
0381-1412	HC 1270C	90°	72 in. (182.9 cm)
0381-1413	HC 1271C	75°	72 in. (182.9 cm)
0381-1414	HC 1272C	180°	72 in. (182.9 cm)
0381-1424	HC 1280C	90°	84 in. (213.4 cm)
0381-1418	HC 1290C	90°	96 in. (243.8 cm)

\*Locking Lever

**For best performance, use the following recommended equipment:**

#### Flashback Arrestors

Gas Service	Part No.	Model	Type	Recommended Tip Size
Oxygen	0657-0010	*FB-O	Torch Mount	Up to size: 8
	0657-0014	FB-OR	Regulator Mount	Up to size: 8
	0657-0076	*FBHC-O	Torch Mount/High Flow	10 and larger
	0657-0078	FBHC-OR	Regulator Mount/High Flow	10 and larger
Fuel	0657-0011	*FB-F	Torch Mount	-
	0657-0015	FB-FR	Regulator Mount	-

\* Torch mount models also protect the hose

#### Hoses

(Contact local distributor for hose information)

- Oxygen:
  - 3/8 in. (9.5 mm) I.D. with "B" hose (9/16"-18 LH) connections
  - Use T-grade hose
- Fuel:
  - 3/8 in. (9.5 mm) I.D. with "B" hose (9/16"-18 LH) connections
  - Use T-grade hose

#### Regulators

- Oxygen:
  - ELC4, ESS7-125-540, SR 450D- 540 Cylinder, SR 700D-540 cylinder or L 700D/E-500/750 line supply
- Fuel:
  - SR 461D-510 cylinder, SR 711B/C/D-510 or L 711B/C/D-500/750 line supply

## Bulldog™ - HC 1100C

Victor Heavy Industry  
Scrap Straight Cutting Torch



With Bulldog torches, superior performance and productivity are assured. The low profile head and lightweight design, strength and durability put Bulldog in a class by itself.

The HC 1100C is manufactured without built-in flashback arrestors. Revers flow check valves are installed at the inlet connection

- Patented head and mixer
- Bottom rear lever with pin/clip design
- Specially designed 'supercharged' preheat oxygen valve
- Reduces flame blow-off
- Bottom located valves for right or left hand use
- Threaded inlet connections with integral check valve for ease of repair
- Body designed for high flow applications
- 3 heavy duty tube supports for ultra strength and durability on extra length models
- UltraMix low-pressure mixer specially designed for LP gas
- Sleek low profile head with no protrusions to hinder cutting
- For use with propane and natural gas

### Bulldog tips by Victor offer a cost effective alternative for efficient scrap cutting

- For scrap cutting
- Heavy wall - two piece design
- Resists slag build-up
- Available in Victor and Harris® styles

### Ordering Information

Part No.	Model No.	Lever Position	Tip Series	Head Angle	Overall Length
<b>Victor Bulldog with Victor Head</b>					
0381-1703	HC 1100C	Bottom Rear	1	90°	21 in. (53.3 cm)
0381-1704	HC 1101C	Bottom Rear	1	75°	21 in. (53.3 cm)
0381-1709	HC 1130C	Bottom Rear	1	90°	36 in. (91.4 cm)
0381-1710	HC 1131C	Bottom Rear	1	75°	36 in. (91.4 cm)
0381-1711	HC 1132C	Bottom Rear	1	180°	36 in. (91.4 cm)
0381-1712	HC 1150C	Bottom Rear	1	90°	48 in. (121.9 cm)
0381-1713	HC 1151C	Bottom Rear	1	75°	48 in. (121.9 cm)
0381-1714	HC 1152C	Bottom Rear	1	180°	48 in. (121.9 cm)
0381-1716	HC 1161C	Bottom Rear	1	75°	60 in. (152.4 cm)
0381-1717	HC 1162C	Bottom Rear	1	180°	60 in. (152.4 cm)
0381-1718	HC 1170C	Bottom Rear	1	90°	72 in. (182.9 cm)
0381-1719	HC 1171C	Bottom Rear	1	75°	72 in. (182.9 cm)
0381-1720	HC 1172C	Bottom Rear	1	180°	72 in. (182.9 cm)
<b>Victor Bulldog with Seat Designed for Harris® Style Tip</b>					
0381-1698	HC 1100C H1	Bottom Rear	1	90°	21" (53.3 cm)
0381-1721	HC 1131C H1	Bottom Rear	1	75°	36" (91.4 cm)
0381-1722	HC 1151C H1	Bottom Rear	1	75°	48" (121.9 cm)
0381-1745	HC 1171C H1	Bottom Rear	1	75°	72" (182.9 cm)

Harris® is a registered trademark of the Lincoln Electric Company.

**WARNING:** Use add-on flashback arrestors.  
Not for use with acetylene.

For best performance, use the following recommended equipment:

### Flashback Arrestors

Gas Service	Part No.	Model	Type	Recommended Tip Size
Oxygen	0657-0010	*FB-O	Torch Mount	Up to size: 8
	0657-0014	FB-OR	Regulator Mount	Up to size: 8
	0657-0076	*FBHC-O	Torch Mount/High Flow	Size: 10 and larger
	0657-0078	FBHC-OR	Regulator Mount/High Flow	Size: 10 and larger
Fuel	0657-0011	*FB-F	Torch Mount	—
	0657-0015	FB-FR	Regulator Mount	—

\*Torch mount models also protect the hose

### Hoses

(Contact local distributor for hose information)

- Oxygen:
  - 3/8 in. (9.53 mm) I.D. with "B" hose (9/16"-18 LH) connections.
  - Use T-grade hose
- Fuel:
  - 3/8 in. (9.53 mm) I.D. with "B" hose (9/16"-18 LH) connections.
  - Use T-grade hose

### Regulators

- Oxygen:
  - ELC4, ESS7-125-540, SR 450D-540, SR 700D-540 cylinder, SR 700E-540 cylinder or L 700D/E-500/750 line supply, LC 350DR 540 liquid cylinder
- Fuel:
  - SR 461D-510 cylinder, SR 711B/C/D-510, L 711B/C/D-500/750 line supply



## ST 2600FC Series

### Heavy Duty Straight Cutting Torch



For use with all fuel gases with appropriate tip.

- Cutting capacity 1/8 in. (3.2 mm) to 8 in. (203.2 mm)
- Includes built-in patented flashback arrestors and reverse flow check valves for added safety

Ordering Information					
Part No.	Model No.	Lever Position	Tip Series	Head Angle	Length
0381-1486	SST 2600FC	Top Rear	1	90°	17 in. (43.2 cm)
0381-1487	SST 2601FC	Top Rear	1	75°	17 in. (43.2 cm)
0381-1480	ST 2600FC	Top Rear	1	90°	21 in. (53.3 cm)
0381-1482	ST 2601FC	Top Rear	1	75°	21 in. (53.3 cm)
0381-1483	ST 2601FCL*	Top Rear	1	75°	21 in. (53.3 cm)
0381-1484	ST 2602FC	Top Rear	1	180°	21 in. (53.3 cm)
0381-1490	ST 2610FC	Top Rear	1	90°	27 in. (68.6 cm)
0381-1491	ST 2611FC	Top Rear	1	75°	27 in. (68.6 cm)
0381-1492	ST 2612FC	Top Rear	1	180°	27 in. (68.6 cm)
0381-1496	ST 2630FC	Top Rear	1	90°	36 in. (91.4 cm)
0381-1498	ST 2631FC	Top Rear	1	75°	36 in. (91.4 cm)
0381-1500	ST 2632FC	Top Rear	1	180°	36 in. (91.4 cm)
0381-1502	ST 2650FC	Top Rear	1	90°	48 in. (121.9 cm)
0381-1503	ST 2651FC	Top Rear	1	75°	48 in. (121.9 cm)
0381-1514	ST 2651FCL*	Top Rear	1	75°	48 in. (121.9 cm)
0381-1504	ST 2652FC	Top Rear	1	180°	48 in. (121.9 cm)
0381-1515	ST 2652FCL*	Top Rear	1	180°	48 in. (121.9 cm)
0381-1506	ST 2670FC	Top Rear	1	90°	72 in. (182.9 cm)
0381-1508	ST 2671FC	Top Rear	1	75°	72 in. (182.9 cm)
0381-1510	ST 2672FC	Top Rear	1	180°	72 in. (182.9 cm)

\*Locking lever

## ST 1000FC Series

### Heavy Duty Straight Cutting Torch



For use with all fuel gases with appropriate tip.

- Cutting capacity 1/8 in. (3.2 mm) to 5 in. (127.0 mm)
- Includes built-in patented flashback arrestors and reverse flow check valves for added safety
- Built-in flashback arrestors no need for accessory flash arrestors
- Built-in reverse flow check valves no need for accessory check valves

Ordering Information					
Part No.	Model No.	Lever Position	Tip Series	Head Angle	Length
0381-1640	SST 1000FC	Bottom Rear	1	90°	17 in. (43.2 cm)
0381-1642	SST 1001FC	Bottom Rear	1	75°	17 in. (43.2 cm)
0381-1641	ST 1000FC	Bottom Rear	1	90°	21 in. (53.3 cm)
0381-1643	ST 1001FC	Bottom Rear	1	75°	21 in. (53.3 cm)
0381-1644	ST 1030FC	Bottom Rear	1	90°	36 in. (91.4 cm)
0381-1645	ST 1031FC	Bottom Rear	1	75°	36 in. (91.4 cm)
0381-1646	ST 1032FC	Bottom Rear	1	180°	36 in. (91.4 cm)
0381-1647	ST 1050FC	Bottom Rear	1	90°	48 in. (121.9 cm)
0381-1648	ST 1051FC	Bottom Rear	1	75°	48 in. (121.9 cm)
0381-1649	ST 1052FC	Bottom Rear	1	180°	48 in. (121.9 cm)

## ST 900FC Series

### Heavy Duty Straight Cutting Torch



For use with all fuel gases with appropriate tip.

- Cutting capacity: 1/8 in. (3.2 mm) to 5 in. (127.0 mm)
- Hose connections are 9/16" - 18 unless noted
- Includes built-in patented flashback arrestors and reverse flow check valves for added safety
- Built-in flashback arrestors no need for accessory flash arrestors
- Built-in reverse flow check valves no need for accessory check valves

#### Ordering Information

Part No.	Model No.	Lever Position	Tip Series	Head Angle	Length
0381-1620	SST 900FC	Top Rear	1	90°	17 in. (43.2 cm)
0381-1622	SST 901FC	Top Rear	1	75°	17 in. (43.2 cm)
0381-1621	ST 900FC	Top Rear	1	90°	21 in. (53.3 cm)
0381-1623	ST 901FC	Top Rear	1	75°	21 in. (53.3 cm)
0381-1628	ST 912FC	Top Rear	1	180°	27 in. (68.6 cm)
0381-1624	ST 930FC	Top Rear	1	90°	36 in. (91.4 cm)
0381-1625	ST 931FC	Top Rear	1	75°	36 in. (91.4 cm)
0381-1626	ST 932FC	Top Rear	1	180°	36 in. (91.4 cm)
0381-1629	ST 950FC	Top Rear	1	90°	48 in. (121.9 cm)
0381-1630	ST 951FC	Top Rear	1	75°	48 in. (121.9 cm)
0381-1631	ST 952FC	Top Rear	1	180°	48 in. (121.9 cm)
0381-1654	ST 972FC	Top Rear	1	180°	72 in. (182.9 cm)
0381-1685	ST 991FC	Top Rear	1	75°	96 in. (243.8 cm)

## ST 400C Series

### Heavy Duty



For use with all fuel gases 5 psig and above.

- Cutting capacity up to 6 in. (155 mm)
- Hose connections are 9/16" - 18 unless noted
- Built-in reverse flow check valves no need for accessory check valves

#### Intuitive knobs:

- Color-coded
- Clearly marked lettering with increase/decrease label
- Understandable in any language

#### Special designed alloy Material:

- 3x the tensile strength of Brass
- Ergonomic, textured, precision contoured handle is designed to reduce operator fatigue and provide better grip

#### Ordering Information

Part No.	Model No.	Lever Position	Tip Series	Head Angle	Length
0381-1987	ST 400C	Top Rear	1	90°	21 in. (53.3 cm)

## ST 300FC Series

### Heavy Duty



For use with all fuel gases with appropriate tip.

- Cutting capacity 1/8 in. (3.2 mm) to 5 in. (127.0 mm)
- Hose connections are 9/16" - 18 unless noted
- Includes built-in patented flashback arrestors and reverse flow check valves for added safety
- Built-in reverse flow check valves

#### Ordering Information

Part No.	Model No.	Lever Position	Tip Series	Head Angle	Length
0381-1917	ST 300FC	Top Rear	1	90°	21 in. (53.3 cm)

## Victor Machine Torches

Available in two and three hose versions. Two hose torches are available in 4.5 in. (114.3 mm), 10 in. (254.0 mm) and 18 in. (457.2 mm) models, and three hose torches are available in 10 in. (254.0 mm) and 18 in. (457.2 mm) models.

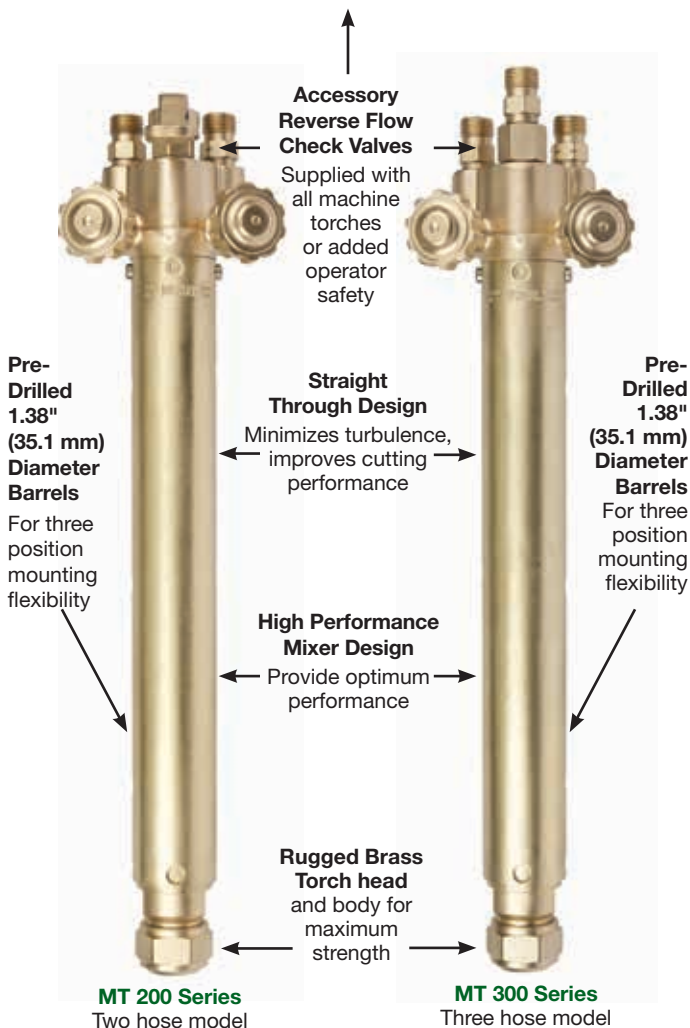
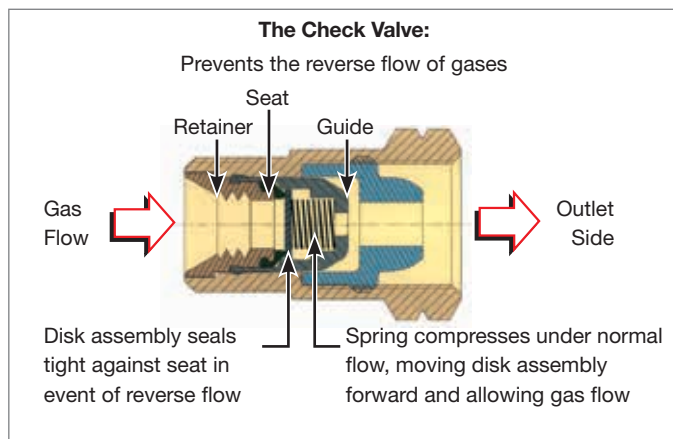

## Straight Cutting Torches & Cutting Machine Reference Guide

Torch Model	Tip Series	Fuel Gas Usage	Cut Capacity
<b>“FC” Models</b>			
ST 2600FC VanGuard	1	Any Fuel Gas	1/8 in. to 8 in. (3.2 to 203.2 mm)
ST 1000FC VanGuard	1	Any Fuel Gas	1/8 in. to 5 in. (3.2 to 127.0 mm)
ST 900FC VanGuard	1	Any Fuel Gas	1/8 in. to 5 in. (3.2 to 127.0 mm)
<b>Machine Torches</b>			
MT 200 (2 Hose)	1	Any Fuel Gas	7 in. (177.8 mm)
MT 300 (3 Hose)	1	Any Fuel Gas	12 in. (304.8 mm)
MT 1065 (3 Hose)	1	Any Fuel Gas	7 in. (177.8 mm)
MT 5 (3 Hose)	1	Any Fuel Gas	7 in. (177.8 mm)

### Tip Type

**BTN** for use with Natural Gas & Propane.

**BTMP** for use with Propylene Gases

(For use with MT200, MT300 Series Machine Cutting Torches)

Length of Bevel	Tip Size	Speed IPM	Oxygen Pressure	Fuel Pressure	Cutting Oxygen Pressure
<b>MT 200 Series</b>					
1	4	10/18	60/75	8/10	—
1.5	4	8/16	60/75	8/10	—
2	4	6/14	60/75	8/10	—
2.5	4	5/12	60/75	8/10	—
3	5	6/11	60/75	8/12	—
3.5	5	5/10	60/75	8/12	—
4	5	4/9	60/75	8/12	—
4.5	5	4/8	60/75	8/12	—
5	6	3/8	65/85	8/15	—
5.5	6	3/7	65/85	8/15	—
6	6	3/6	65/85	8/15	—
<b>MT 300N Series</b>					
1	4	10/18	35/65	10/12	40/60
1.5	4	8/16	35/65	10/12	40/60
2	4	6/14	35/65	10/12	40/60
2.5	4	5/12	35/65	10/12	40/60
3	5	6/11	35/65	10/12	40/65
3.5	5	5/10	35/65	10/12	40/65
4	5	4/9	35/65	10/12	40/65
4.5	5	4/8	35/65	10/12	40/65
5	6	3/8	35/65	10/12	40/75
5.5	6	3/7	35/65	10/12	40/75
6	6	3/6	35/65	10/12	40/75

Bevels of 30° to 70° are possible on mild steel and most alloy steel without a preheat attachment. High gas withdrawal rates will require manifolding. Consult your gas supplier.

GAS TORCHES

Victor machine cutting torches are available in two and three hose models. Three hose torches are high performance “straight through” design that minimizes turbulence and improves cut quality. Accessory reverse flow check valves are supplied for use at the torches inlet connection. All machine torches use Series 1 cutting tips and are supplied with accessory reverse flow check valves to be used on the torch inlet connections.

## MT 300 Series

Three Hose



- Cut capacity: 12 in. (304.8 mm)
- Series 1 cutting tips

Ordering Information					
Part No.	Model No.	Total Length	Barrel Length	Racking Length	Gas
0380-0222	MT 310A	14 in. (355.6 mm)	10 in. (254.0 mm)	7 in. (177.8 mm)	Acetylene*
0380-0220	MT 310N	14 in. (355.6 mm)	10 in. (254.0 mm)	7 in. (177.8 mm)	LP/Natural Gas**
0380-0221	MT 310NV	14 in. (355.6 mm)	10 in. (254.0 mm)	7 in. (177.8 mm)	LP/Natural Gas**
0380-0223	MT 310AV	14 in. (355.6 mm)	10 in. (254.0 mm)	7 in. (177.8 mm)	Acetylene*
0380-0227	MT 318A	22.5 in. (571.5 mm)	18 in. (457.2 mm)	15 in. (381.0 mm)	Acetylene*
0380-0228	MT 318AV	22.5 in. (571.5 mm)	18 in. (457.2 mm)	15 in. (381.0 mm)	Acetylene*
0380-0225	MT 318N	22.5 in. (571.5 mm)	18 in. (457.2 mm)	15 in. (381.0 mm)	LP/Natural Gas**
0380-0226	MT 318NV	22.5 in. (571.5 mm)	18 in. (457.2 mm)	15 in. (381.0 mm)	LP/Natural Gas**

\*May also be used on other pressurized fuel gases  
 \*\*May also be used on other fuel gases except acetylene  
 Other machine torch models available. Ask for details  
 Gear racks: must be ordered separately

## MT 5

Three Hose



- Cutting capacity - 7 in. (177.8 mm)
- For use with any fuel gas 2 PSI and above
- Series 1 cutting tips
- Supplied with rack soldered to barrel

Ordering Information						
Part No.	Model No.	Total Length	Barrel Diameter	Barrel Length	Racking Length	Gas
0380-0208	MT 5	8.5 in. (215.9 mm)	1.38 in. (35.1 mm)	5.38 in. (136.7 mm)	5.38 in. (136.7 mm)	All

## MT 200 Series

Two Hose



- Cut capacity: 7 in. (177.8 mm)
- Series 1 cutting tips

Ordering Information					
Part No.	Model No.	Total Length	Barrel Length	Racking Length	Gas
0380-0215	MT 204A	8.5 in. (215.9 mm)	4.5 in. (114.3 mm)	–	Acetylene*
0397-0217	MT 204A***	8.5 in. (215.9 mm)	4.5 in. (114.3 mm)	–	Acetylene*
0380-0217	MT 210A	14 in. (355.6 mm)	10 in. (254.0 mm)	7 in. (177.8 mm)	Acetylene*
0380-0216	MT 210N	14 in. (355.6 mm)	10 in. (254.0 mm)	7 in. (177.8 mm)	LP/Natural Gas**

\*May also be used on other pressurized fuel gases.  
 \*\*May also be used on other fuel gases except acetylene.  
 \*\*\*Supplied with rack soldered to barrel.  
 Other machine torch models available. Ask for details.  
 Gear racks: Must be ordered separately.

## MT 1065

Three Hose



- Cut capacity: 7 in. (177.8 mm)
- For use with all fuel gases
- Series 1 cutting tips
- Multi-torch beveling

Ordering Information					
Part No.	Model No.	Total Length	Barrel Diameter	Barrel Length	Gas
0399-1065	MT 1065N	8 in. (203.2 mm)	1.25 in. (31.8 mm)	4 in. (101.6 mm)	All
0399-1121	MT 1065A	8 in. (203.2 mm)	1.25 in. (31.8 mm)	4 in. (101.6 mm)	Acetylene

## Gear Racks

- For use with MT 200 and MT 300 Series cutting torches
- Must be ordered separately















Ordering Information				
Part No.	Length	Pitch	Cutting Machine	Actual Length
0319-0054	10 in. (254.0 mm) Rack Kit	32	MT 210 & MT 310	7.8 in. (198.1 mm)
0319-0055	18 in. (457.2 mm) Rack Kit	32	MT 318	14.5 in. (368.3 mm)

## Section & Reference Information

### Cutting Orifice Reference Chart - Cutting Tip Size

For all standard cutting tips except Series MTH high speed models

000	00	0	1	2	3	4	5	6	7	8	10	12
												
0.027	0.033	0.041	0.047	0.060	0.071	0.083	0.100	0.121	0.141	0.162	0.185	0.221

Orifice Diameter – inches (Orifice diameters shown actual size)

### Code for Fuel Gases

<b>A</b>	<b>Acetylene</b>
<b>LP</b>	<b>Propane/Natural Gas</b>
<b>P</b>	<b>Propylene</b>

### Preheat Chart for Propylene & LP Tips

Torch Series	Preheat Oxygen (psig)	Preheat Fuel (psig)
MT 200	--	8 oz and up
MT 300	30/35	8 oz and up
ST 2600FC	--	1 psig and up
ST 900FC	--	5 psig and up
ST 1000FC	--	5 psig and up

### Material Thickness – Tip Size

Material Thickness		Tip Size
Inches	mm	
1/8 in.	3.2 mm	000
1/4 in.	6.4 mm	00
3/8 – 1/2 in.	9.5 - 12.7 mm	0
3/4 in.	19.1 mm	1
1 – 1 1/2 in.	25.4 - 38.1 mm	2
2 – 2 1/2 in.	50.8 - 63.5 mm	3
3 in.	76.2 mm	4
4 – 5 in.	102 - 127 mm	5
6 – 8 in.	152 - 203 mm	6*
10 in.	254 mm	7*
12 in.	305 mm	8*

\*For best results, use "High Flow Handles" and 3/8" hose

### Cutting Torches

Handle	Cutting Attachment	Fuel Gas
<b>Cutting Torches</b>		
315FC, H 315FC	CA 2460-90°	All
315FC, H 315FC	CA 2461-75°	All
315FC, H 315FC	CA 2462-180°	All
<b>Straight Torches</b>		
ST 2600FC	–	All
ST 1000FC	–	All
ST 900FC	–	All
*HC 1200C	–	All
<b>Machine Torches</b>		
MT 200	–	A, LP
MT 300	–	A, LP

### Gouging Depth Tip Chart

Approximate Gouge Depth				
Depth of gouge will vary due to angle of tip and cutting pressure.				
Type	Tip Size	Depth of Gouge	O <sub>2</sub> psi	C <sub>2</sub> H <sub>2</sub> psi
118	0	1/8 in. - 1/4 in.	30-45	5-7
	2	1/4 in. - 3/8 in.	30-45	5-7
	8	1/4 in. - 1/2 in.	30-55	6-8
218	4	1/4 in. - 3/4 in.	30-65	8-10
	6	3/8 in. - 1 in.	30-65	10-12

#### Tip Nut

**0309-0018**  
For Series 1 cutting tips









**0309-0003**  
For Series 3 cutting tips

Series 1 – Acetylene Cutting Tips

Acetylene

Series 1 tip style, fuel gas usage and Victor equipment compatibility shown below

Type		Fuel Gas	Application
101		A	<ul style="list-style-type: none"> <li>General purpose</li> <li>Hand and machine torch cutting</li> </ul>
101 30°		A	<ul style="list-style-type: none"> <li>General purpose</li> <li>Hand and machine torch cutting 30°, with torch perpendicular</li> </ul>
101-L		A	<ul style="list-style-type: none"> <li>General purpose, extra length tips</li> </ul>
108		A	<ul style="list-style-type: none"> <li>Boiler tube removal</li> <li>Tips are short to insert head and tip inside tube</li> </ul>
112		A	<ul style="list-style-type: none"> <li>Cutting close to bulk heads</li> <li>Hand cutting of rivet heads</li> </ul>
118 Tip (Round)		A	<ul style="list-style-type: none"> <li>Deseaming, scarfing, gouging, weld preparation, removing defective welds, washing rivets</li> </ul>
118 Tip (Sides Cutaway)		A	<ul style="list-style-type: none"> <li>Deseaming, scarfing, gouging, weld preparation, removing defective welds, washing rivets</li> </ul>

Tip packaging is color coded with reference to fuel gas usage. Other special application tips available. Contact Technical Services at 1-800-426-1888

CUTTING TIPS



Data compiled using mild steel as test material.

\*Applicable for three hose machine torch only. With a two hose cutting torch, preheat pressure is set by the cutting oxygen.

\*\*For best results use ST 2600FC series torches and 3/8 in. hose when using tip size 6 or larger.

\*\*\*All pressures are measured at the regulator using 25 ft x 1/4 in. hose through tip size 5 and 25 ft x 3/8 in.

\*\*\*\*Oxygen consumption is 1.1 times the acetylene under neutral flame conditions.

**WARNING:** At no time should the withdrawal rate of an individual acetylene cylinder exceed 1/7 of the cylinder contents per hour. If additional flow capacity is required use an acetylene manifold system of sufficient size to supply the necessary volume.

## Victor Series 1 Type 101



- General purpose
- Hand and machine torch cutting

Metal Thickness	Size	Part No.	Cutting Oxygen *** (psig)	Cutting Oxygen (SCFH)	Preheat Oxygen *(psig)	Preheat Oxygen (SCFH)	Fuel (psig)	Fuel **** (SCFH)	Speed ipm	Kerf Width
1/8 in. (3.2 mm)	000	0330-0003	20 / 25	20 / 25	3 / 5	3 / 5	3 / 5	3 / 5	28 / 32	.04
1/4 in. (6.4 mm)	00	0330-0004	20 / 25	30 / 35	3 / 5	4 / 6	3 / 5	4 / 6	27 / 30	.05
1/4 in. (6.4 mm)	00	0387-0133#	20 / 25	30 / 35	3 / 5	4 / 6	3 / 5	4 / 6	27 / 30	.05
3/8 in. (9.5 mm)	0	0330-0012	25 / 30	55 / 60	3 / 5	5 / 9	3 / 5	5 / 8	24 / 28	.06
3/8 in. (9.5 mm)	0	0387-0134#	25 / 30	55 / 60	3 / 5	5 / 9	3 / 5	5 / 8	24 / 28	.06
1/2 in. (12.7 mm)	0	0330-0012	30 / 35	60 / 65	3 / 6	7 / 11	3 / 5	6 / 10	20 / 24	.06
1/2 in. (12.7 mm)	0	0387-0134#	30 / 35	60 / 65	3 / 6	7 / 11	3 / 5	6 / 10	20 / 24	.06
3/4 in. (19.1 mm)	1	0330-0005	30 / 35	80 / 85	4 / 7	9 / 14	3 / 5	8 / 13	17 / 21	.07
3/4 in. (19.1 mm)	1	0387-0135#	30 / 35	80 / 85	4 / 7	9 / 14	3 / 5	8 / 13	17 / 21	.07
1 in. (25.4 mm)	2	0330-0006	40 / 45	150 / 160	4 / 12	13 / 20	3 / 7	12 / 18	13 / 17	.09
1 in. (25.4 mm)	2	0387-0136#	40 / 45	150 / 160	4 / 12	13 / 20	3 / 7	12 / 18	13 / 17	.09
1 1/2 in. (38.1 mm)	2	0330-0006	40 / 45	150 / 160	4 / 12	13 / 20	3 / 7	12 / 18	13 / 17	.09
1 1/2 in. (38.1 mm)	2	0387-0136#	40 / 45	150 / 160	4 / 12	13 / 20	3 / 7	12 / 18	13 / 17	.09
2 in. (50.8 mm)	3	0330-0002	40 / 45	210 / 225	5 / 14	15 / 24	4 / 9	14 / 22	12 / 15	.11
2 1/2 in. (63.5 mm)	3	0330-0002	45 / 50	225 / 240	5 / 16	18 / 29	4 / 10	16 / 26	10 / 13	.11
3 in. (76.2 mm)	4	0330-0007	40 / 50	270 / 320	6 / 17	20 / 33	5 / 10	18 / 30	9 / 12	.12
4 in. (102 mm)	5	0330-0008	45 / 55	390 / 425	7 / 18	24 / 37	5 / 12	22 / 34	8 / 11	.15
5 in. (127 mm)	5	0330-0008	50 / 55	425 / 450	7 / 20	29 / 41	5 / 13	26 / 38	7 / 9	.15
6 in. (152 mm)	6**	0330-0009	45 / 40	500 / 600	10 / 22	33 / 48	7 / 13	30 / 44	6 / 8	.18
8 in. (203 mm)	6**	0330-0009	45 / 55	500 / 600	10 / 25	37 / 55	7 / 14	34 / 50	5 / 6	.19
10 in. (254 mm)	7**	0330-0013	45 / 55	700 / 850	15 / 30	44 / 62	10 / 15	40 / 56	4 / 5	.34
12 in. (305 mm)	8**	0330-0014	45 / 55	900 / 1000	20 / 35	53 / 68	10 / 15	48 / 62	3 / 5	.41

## G-Series Series 1 Type 101

Metal Thickness	Size	Part No.	Cutting Oxygen *** (psig)	Cutting Oxygen (SCFH)	Preheat Oxygen *(psig)	Preheat Oxygen (SCFH)	Fuel (psig)	Fuel **** (SCFH)	Speed ipm	Kerf Width
1/8 in. (3.2 mm)	000	CS1101000	20 / 25	20 / 25	3 / 5	3 / 5	3 / 5	3 / 5	28 / 32	.04
1/4 in. (6.4 mm)	00	CS110100	20 / 25	30 / 35	3 / 5	4 / 6	3 / 5	4 / 6	27 / 30	.05
3/8 in. (9.5 mm)	0	CS11010	25 / 30	55 / 60	3 / 5	5 / 9	3 / 5	5 / 8	24 / 28	.06
1/2 in. (12.7 mm)	0	CS11010	30 / 35	60 / 65	3 / 6	7 / 11	3 / 5	6 / 10	20 / 24	.06
3/4 in. (19.1 mm)	1	CS11011	30 / 35	80 / 85	4 / 7	9 / 14	3 / 5	8 / 13	17 / 21	.07
1 in. (25.4 mm)	2	CS11012	35 / 40	140 / 150	4 / 9	11 / 18	3 / 6	10 / 16	15 / 19	.09
1 1/2 in. (38.1 mm)	2	CS11012	40 / 45	150 / 160	4 / 12	13 / 20	3 / 7	12 / 18	13 / 17	.09
2 in. (50.8 mm)	3	CS11013	40 / 45	210 / 225	5 / 14	15 / 24	4 / 9	14 / 22	12 / 15	.11
2 1/2 in. (63.5 mm)	3	CS11013	45 / 50	225 / 240	5 / 16	18 / 29	4 / 10	16 / 26	10 / 13	.11
3 in. (76.2 mm)	4	CS11014	40 / 50	270 / 320	6 / 17	20 / 33	5 / 10	18 / 30	9 / 12	.12
4 in. (102 mm)	5	CS11015	45 / 55	390 / 425	7 / 18	24 / 37	5 / 12	22 / 34	8 / 11	.15
5 in. (127 mm)	5	CS11015	50 / 55	425 / 450	7 / 20	29 / 41	5 / 13	26 / 38	7 / 9	.15
6 in. (152 mm)	6**	CS11016	45 / 40	500 / 600	10 / 22	33 / 48	7 / 13	30 / 44	6 / 8	.18
8 in. (203 mm)	6**	CS11016	45 / 55	500 / 600	10 / 25	37 / 55	7 / 14	34 / 50	5 / 6	.19
10 in. (254 mm)	7**	CS11017	45 / 55	700 / 850	15 / 30	44 / 62	10 / 15	40 / 56	4 / 5	.34
12 in. (305 mm)	8**	CS11018	45 / 55	900 / 1000	20 / 35	53 / 68	10 / 15	48 / 62	3 / 5	.41

CUTTING TIPS

## Victor Series 1 Type 101 30°



- General purpose
- Hand and machine torch cutting 30°, with torch perpendicular

Metal Thickness	Size	Part No.	Cutting Oxygen*** (psig)	Cutting Oxygen (SCFH)	Preheat Oxygen * (psig)	Preheat Oxygen (SCFH)	Acetylene (psig)	Acetylene ****(SCFH)	Speed ipm	Kerf Width
3/8 in. (0.9 mm)	0	0330-0198	25 / 30	55 / 60	3 / 5	5 / 9	3 / 5	5 / 8	24 / 28	.06
1/2 in. (1.2 mm)	0	0330-0198	30 / 35	60 / 65	3 / 6	7 / 11	3 / 5	6 / 10	20 / 24	.06
3/4 in. (1.9 mm)	1	0330-0199	30 / 35	80 / 85	4 / 7	9 / 14	3 / 5	8 / 13	17 / 21	.07
1 in. (2.5 mm)	2	0330-0284	35 / 40	140 / 150	4 / 9	11 / 18	3 / 6	10 / 16	15 / 19	.09

## Victor Series 1 Type 101-L

- General purpose
- Extra length tips



Metal Thickness	Size	Part No.	Cutting Oxygen *** (psig)	Cutting Oxygen (SCFH)	Preheat Oxygen * (psig)	Preheat Oxygen (SCFH)	Acetylene (psig)	Acetylene ****(SCFH)	Speed ipm	Kerf Width
3 in. (7.6 mm)	4	0330-0531	40 / 50	270 / 320	6 / 17	20 / 33	5 / 10	18 / 30	9 / 12	.12
6 in. (15.2 mm)	6**	0330-0535	45 / 40	500 / 600	10 / 22	33 / 48	7 / 13	30 / 44	6 / 8	.18

## Victor Series 1 Type 108



- Boiler tube removal
- Tip is short to insert head and tip inside tube

Metal Thickness	Size	Part No.	Cutting Oxygen *** (psig)	Cutting Oxygen (SCFH)	Preheat Oxygen * (psig)	Preheat Oxygen (SCFH)	Acetylene (psig)	Acetylene ****(SCFH)	Speed ipm	Kerf Width
3/8 in. (0.9 mm)	0	0330-0058	25 / 30	55 / 60	3 / 5	5 / 9	3 / 5	5 / 8	24 / 28	.06
1/2 in. (1.2 mm)	0	0330-0058	30 / 35	60 / 65	3 / 6	7 / 11	3 / 5	6 / 10	20 / 24	.06
3/4 in. (1.9 mm)	1	0330-0059	30 / 35	80 / 85	4 / 7	9 / 14	3 / 5	8 / 13	17 / 21	.07
1 in. (2.5 mm)	2	0330-0063	35 / 40	140 / 150	4 / 9	11 / 18	3 / 6	10 / 16	15 / 19	.09
1 1/2 in. (3.8 mm)	2	0330-0063	40 / 45	150 / 160	4 / 12	13 / 20	3 / 7	12 / 18	13 / 17	.09
2 in. (5 mm)	3	0330-0064	40 / 45	210 / 225	5 / 14	15 / 24	4 / 9	14 / 22	12 / 15	.11
2 1/2 in. (6.4 mm)	3	0330-0064	45 / 50	225 / 240	5 / 16	18 / 29	4 / 10	16 / 26	10 / 13	.11
3 in. (7.6 mm)	4	0330-0065	40 / 50	270 / 320	6 / 17	20 / 33	5 / 10	18 / 30	9 / 12	.12

## G-Series Series 1 Type 108

Metal Thickness	Size	Part No.	Cutting Oxygen *** (psig)	Cutting Oxygen (SCFH)	Preheat Oxygen * (psig)	Preheat Oxygen (SCFH)	Acetylene (psig)	Acetylene ****(SCFH)	Speed ipm	Kerf Width
3/8 in. (0.9 mm)	0	CS11080	25 / 30	55 / 60	3 / 5	5 / 9	3 / 5	5 / 8	24 / 28	.06
1/2 in. (1.2 mm)	0	CS11080	30 / 35	60 / 65	3 / 6	7 / 11	3 / 5	6 / 10	20 / 24	.06
3/4 in. (1.9 mm)	1	CS11081	30 / 35	80 / 85	4 / 7	9 / 14	3 / 5	8 / 13	17 / 21	.07
1 in. (2.5 mm)	2	CS11082	35 / 40	140 / 150	4 / 9	11 / 18	3 / 6	10 / 16	15 / 19	.09
1 1/2 in. (3.8 mm)	2	CS11082	40 / 45	150 / 160	4 / 12	13 / 20	3 / 7	12 / 18	13 / 17	.09
2 in. (5 mm)	3	CS11083	40 / 45	210 / 225	5 / 14	15 / 24	4 / 9	14 / 22	12 / 15	.11
2 1/2 in. (6.4 mm)	3	CS11083	45 / 50	225 / 240	5 / 16	18 / 29	4 / 10	16 / 26	10 / 13	.11
3 in. (7.6 mm)	4	CS11084	40 / 50	270 / 320	6 / 17	20 / 33	5 / 10	18 / 30	9 / 12	.12

CUTTING TIPS

Data compiled using mild steel as test material.

\*Applicable for three hose machine torch only. With a two hose cutting torch, preheat pressure is set by the cutting oxygen.

\*\*For best results use ST 2600FC series torches and 3/8 in. hose when using tip size 6 or larger.

\*\*\*All pressures are measured at the regulator using 25 ft x 1/4 in. hose through tip size 5 and 25 ft x 3/8 in. hose for tip size 6 and larger.

\*\*\*\*Oxygen consumption is 1.1 times the acetylene under neutral flame conditions.

**WARNING:** At no time should the withdrawal rate of an individual acetylene cylinder exceed 1/7 of the cylinder contents per hour. If additional flow capacity is required use an acetylene manifold system of sufficient size to supply the necessary volume.



## Victor Series 1 Type 112



- Cutting close to bulk heads
- Hand cutting of rivet heads

Metal Thickness	Size	Part No.	Cutting Oxygen (psig) ***	Cutting Oxygen (SCFH)	Preheat Oxygen * (psig)	Preheat Oxygen (SCFH)	Acetylene (psig)	Acetylene ****(SCFH)	Speed ipm	Kerf Width
1 in. (2.5 mm)	2	0330-0086	35 / 40	140 / 150	4 / 9	11 / 18	3 / 6	10 / 16	15 / 19	.09
1 1/2 in. (3.8 mm)	2	0330-0086	40 / 45	150 / 160	4 / 12	13 / 20	3 / 7	12 / 18	13 / 17	.09

## Victor Series 1 Type 118 Round)



- Deseaming, scarfing, gouging
- Rivet washing
- Weld preparation

Metal Thickness	Size	Part No.	Cutting Oxygen (psig) ***	Cutting Oxygen (SCFH)	Preheat Oxygen * (psig)	Preheat Oxygen (SCFH)	Acetylene (psig)	Acetylene ****(SCFH)	Speed ipm	Kerf Width
3/8 in. (0.9 mm)	0	0330-0109	25 / 30	55 / 60	3 / 5	5 / 9	3 / 5	5 / 8	24 / 28	.06
1/2 in. (1.2 mm)	0	0330-0109	30 / 35	60 / 65	3 / 6	7 / 11	3 / 5	6 / 10	20 / 24	.06
1 in. (2.5 mm)	2	0330-0113	35 / 40	140 / 150	4 / 9	11 / 18	3 / 6	10 / 16	15 / 19	.09
1 1/2 in. (3.8 mm)	2	0330-0113	40 / 45	150 / 160	4 / 12	13 / 20	3 / 7	12 / 18	13 / 17	.09
3 in. (7.6 mm)	4	0330-0114	40 / 50	270 / 320	6 / 17	20 / 33	5 / 10	18 / 30	9 / 12	.12

## G-Series Series 1 Type 118 (Round)

Metal Thickness	Size	Part No.	Cutting Oxygen (psig) ***	Cutting Oxygen (SCFH)	Preheat Oxygen * (psig)	Preheat Oxygen (SCFH)	Acetylene (psig)	Acetylene ****(SCFH)	Speed ipm	Kerf Width
3/8 in. (0.9 mm)	0	CS11180	25 / 30	55 / 60	3 / 5	5 / 9	3 / 5	5 / 8	24 / 28	.06
1/2 in. (1.2 mm)	0	CS11180	30 / 35	60 / 65	3 / 6	7 / 11	3 / 5	6 / 10	20 / 24	.06
1 in. (2.5 mm)	2	CS11182	35 / 40	140 / 150	4 / 9	11 / 18	3 / 6	10 / 16	15 / 19	.09
1 1/2 in. (3.8 mm)	2	CS11182	40 / 45	150 / 160	4 / 12	13 / 20	3 / 7	12 / 18	13 / 17	.09
3 in. (7.6 mm)	4	CS11184	40 / 50	270 / 320	6 / 17	20 / 33	5 / 10	18 / 30	9 / 12	.12

## Victor Series 1 Type 118 (Sides Cutaway)



- Deseaming, scarfing, gouging
- Rivet washing
- Weld preparation

Metal Thickness	Size	Part No.	Cutting Oxygen (psig) ***	Cutting Oxygen (SCFH)	Preheat Oxygen * (psig)	Preheat Oxygen (SCFH)	Acetylene (psig)	Acetylene ****(SCFH)	Speed ipm	Kerf Width
6 in. (15.2 mm)	6**	0330-0115	45 / 40	500 / 600	10 / 22	33 / 48	7 / 13	30 / 44	6 / 8	.18
8 in. (20.3 mm)	6**	0330-0115	45 / 55	500 / 600	10 / 25	37 / 55	7 / 14	34 / 50	5 / 6	.19
12 in. (30.5 mm)	8**	0330-0116	45 / 55	900 / 1000	20 / 35	53 / 68	10 / 15	48 / 62	3 / 5	.41

## G-Series Series 1 Type 118 (Sides Cutaway)

Metal Thickness	Size	Part No.	Cutting Oxygen (psig) ***	Cutting Oxygen (SCFH)	Preheat Oxygen * (psig)	Preheat Oxygen (SCFH)	Acetylene (psig)	Acetylene ****(SCFH)	Speed ipm	Kerf Width
6 in. (15.2 mm)	6**	CS11186	45 / 40	500 / 600	10 / 22	33 / 48	7 / 13	30 / 44	6 / 8	.18
8 in. (20.3 mm)	6**	CS11186	45 / 55	500 / 600	10 / 25	37 / 55	7 / 14	34 / 50	5 / 6	.19
12 in. (30.5 mm)	8**	CS11188	45 / 55	900 / 1000	20 / 35	53 / 68	10 / 15	48 / 62	3 / 5	.41

Data compiled using mild steel as test material.

\*Applicable for three hose machine torch only. With a two hose cutting torch, preheat pressure is set by the cutting oxygen.

\*\*For best results use ST 2600FC series torches and 3/8 in. hose when using tip size 6 or larger.

\*\*\*All pressures are measured at the regulator using 25 ft x 1/4 in. hose through tip size 5 and 25 ft x 3/8 in. hose for tip size 6 and larger.















\*\*\*\*Oxygen consumption is 1.1 times the acetylene under neutral flame conditions.

**WARNING:** At no time should the withdrawal rate of an individual acetylene cylinder exceed 1/7 of the cylinder contents per hour. If additional flow capacity is required use an acetylene manifold system of sufficient size to supply the necessary volume.

Series 1 – Propylene Cutting Tips

Propylene

Series 1 tip style, fuel gas usage and Victor equipment compatibility shown below

Type		Fuel Gas	Application
GPP	 	P	<ul style="list-style-type: none"> <li>General purpose</li> <li>Hand and machine torch cutting</li> </ul>
HPP	 	P	<ul style="list-style-type: none"> <li>Heavy preheat for scrap, bevel and other heavy preheat requirements</li> </ul>
MTHP	 	P	<ul style="list-style-type: none"> <li>High speed machine cutting through 10" (252 mm)</li> </ul>
303MP	 	P	<ul style="list-style-type: none"> <li>General purpose</li> <li>Hand and machine torch cutting</li> </ul>
	 	P	<ul style="list-style-type: none"> <li>High performance</li> <li>Bevel cutting</li> </ul>
GTB	 	P	<ul style="list-style-type: none"> <li>Gouging tip (bent)</li> <li>Removing welds</li> </ul>
318MP	 	P	<ul style="list-style-type: none"> <li>General purpose</li> <li>Gouging and rivet washing</li> </ul>

Tip packaging is color coded with reference to fuel gas usage. Other special application tips available. Contact Technical Services at 1-800-426-1888



## Victor Series 1 Type GPP



- General purpose
- Hand and machine torch cutting

Metal Thickness	Size	Part No.	Cutting Oxygen *** (psig)	Cutting Oxygen (SCFH)	Preheat Oxygen *(psig)	Preheat Oxygen (SCFH)	Fuel (psig)	Fuel **** (SCFH)	Speed ipm	Kerf Width
1/8 in. (3.2 mm)	000	0333-0260	20/25	12/14	REFERENCE PREHEAT CHART ON PAGE 142	23/108	3/5	5/6	24/28	0.04
1/4 in. (6.4 mm)	00	0333-0261	20/25	22/.26		23/108	3/5	5/7	21/25	0.04
3/8 in. (9.5 mm)	0	0333-0262	25/30	45/55		23/108	3/5	8/10	20/24	0.06
3/8 in. (9.5 mm)	0	0387-0154#	25/30	45/55		23/108	3/5	8/10	20/24	0.06
1/2 in. (12.7 mm)	0	0333-0262	30/35	50/55		23/108	3/5	8/10	18/22	0.06
1/2 in. (12.7 mm)	0	0387-0154#	30/35	50/55		23/108	3/5	8/10	18/22	0.06
3/4 in. (19.1 mm)	1	0333-0263	30/35	70/80		23/108	4/6	10/12	15/20	0.08
3/4 in. (19.1 mm)	1	0387-0155#	30/35	70/80		23/108	4/6	10/12	15/20	0.08
1 in. (25.4 mm)	2	0333-0264	35/40	115/125		23/108	4/8	12/15	14/18	0.09
1 in. (25.4 mm)	2	0387-0156#	35/40	115/125		23/108	4/8	12/15	14/18	0.09
1 1/2 in. (38.1 mm)	2	0333-0264	40/45	125/135		23/108	5/9	12/15	12/16	0.09
2 in. (50.8 mm)	3	0333-0265	40/50	150/175		23/108	5/9	14/18	10/14	0.10
2 1/2 in. (63.5 mm)	3	0333-0265	45/50	175/200		23/108	6/10	14/18	9/12	0.10
3 in. (76.2 mm)	4	0333-0266	45/50	210/250		23/108	8/12	16/20	8/11	0.12
4 in. (102 mm)	5	0333-0267	45/55	300/360		23/108	8/12	20/30	7/10	0.14
5 in. (127 mm)	5	0333-0267	50/55	330/360		23/108	8/12	20/30	6/9	0.14
6 in. (152 mm)	6**	0333-0268	45/55	400/500		23/153	10/15	25/35	5/7	0.17
8 in. (203 mm)	6**	0333-0268	55/65	450/500		23/153	10/15	25/35	4/6	0.18
10 in. (254 mm)	7	0333-0269	55/65	450/500		23/153	8/12	25/35	3/5	0.34
12 in. (305 mm)	8	0333-0270	60/70	450/500		23/153	10/14	25/35	3/4	0.14

## G-Series Series 1 Type GPP

Metal Thickness	Size	Part No.	Cutting Oxygen *** (psig)	Cutting Oxygen (SCFH)	Preheat Oxygen *(psig)	Preheat Oxygen (SCFH)	Fuel (psig)	Fuel **** (SCFH)	Speed ipm	Kerf Width
1/8 in. (3.2 mm)	000	CSGPP000	20/25	12/14	REFERENCE PREHEAT CHART ON PAGE 142	23/108	3/5	5/6	24/28	0.04
1/4 in. (6.4 mm)	00	CSGPP00	20/25	22/.26		23/108	3/5	5/7	21/25	0.04
3/8 in. (9.5 mm)	0	CSGPP0	25/30	45/55		23/108	3/5	8/10	20/24	0.06
1/2 in. (12.7 mm)	0	CSGPP0	30/35	50/55		23/108	3/5	8/10	18/22	0.06
3/4 in. (19.1 mm)	1	CSGPP1	30/35	70/80		23/108	4/6	10/12	15/20	0.08
1 in. (25.4 mm)	2	CSGPP2	35/40	115/125		23/108	4/8	12/15	14/18	0.09
1 1/2 in. (38.1 mm)	2	CSGPP2	40/45	125/135		23/108	5/9	12/15	12/16	0.09
2 in. (50.8 mm)	3	CSGPP3	40/50	150/175		23/108	5/9	14/18	10/14	0.10
2 1/2 in. (63.5 mm)	3	CSGPP3	45/50	175/200		23/108	6/10	14/18	9/12	0.10
3 in. (76.2 mm)	4	CSGPP4	45/50	210/250		23/108	8/12	16/20	8/11	0.12
4 in. (102 mm)	5	CSGPP5	45/55	300/360		23/108	8/12	20/30	7/10	0.14
5 in. (127 mm)	5	CSGPP5	50/55	330/360		23/108	8/12	20/30	6/9	0.14
6 in. (152 mm)	6**	CSGPP6	45/55	400/500		23/153	10/15	25/35	5/7	0.17
8 in. (203 mm)	6**	CSGPP6	55/65	450/500		23/153	10/15	25/35	4/6	0.18
10 in. (254 mm)	7**	CSGPP7	55/65	450/500		23/153	8/12	25/35	3/5	0.34
12 in. (305 mm)	8**	CSGPP8	60/70	450/500		23/153	10/14	25/35	3/4	0.14

Data compiled using mild steel as test material.

\*Applicable for three hose machine torch only. With a two hose cutting torch, preheat pressure is set by the cutting oxygen.

\*\*For best results use ST 2600FC series torches and 3/8 in. hose when using tip size 6 or larger.

\*\*\*All pressures are measured at the regulator using 25 ft x 1/4 in. hose through tip size 5 and 25 ft x 3/8 in. hose for tip size 6 and larger.

\*\*\*\*Oxygen consumption is 1.1 times the acetylene under neutral flame conditions.

CUTTING TIPS

## G-Series Series 1 Type GPP-P (Plated)



- General purpose
- Two-piece
- Medium preheat

Metal Thickness	Size	Part No.	Cutting Oxygen *** (psig)	Cutting Oxygen (SCFH)	Preheat Oxygen * (psig)	Preheat Oxygen (SCFH)	Fuel (psig)	Fuel **** (SCFH)	Speed ipm	Kerf Width
1/4 in. (6.4 mm)	00	CSGPPP00	20/25	22/26	REFERENCE PREHEAT CHART ON PAGE 142	23/108	3/5	5/7	21/25	0.04
3/8 in. (9.5 mm)	0	CSGPPP0	25/30	45/55		23/108	3/5	8/10	20/24	0.06
1/2 in. (12.7 mm)	0	CSGPPP0	30/35	50/55		23/108	3/5	8/10	18/22	0.06
3/4 in. (19.1 mm)	1	CSGPPP1	30/35	70/80		23/108	4/6	10/12	15/20	0.08
1 in. (25.4 mm)	2	CSGPPP2	35/40	115/125		23/108	4/8	12/15	14/18	0.09
1 1/2 in. (38.1 mm)	2	CSGPPP	40/45	125/135		23/108	5/9	12/15	12/16	0.09
2 in. (50.8 mm)	3	CSGPPP3	40/50	150/175		23/108	5/9	14/18	10/14	0.10
2 1/2 in. (63.5 mm)	3	CSGPPP3	45/50	175/200		23/108	6/10	14/18	9/12	0.10
3 in. (76.2 mm)	4	CSGPPP4	45/50	210/250		23/108	8/12	16/20	8/11	0.12
4 in. (102 mm)	5	CSGPPP5	45/55	300/360		23/108	8/12	20/30	7/10	0.14
5 in. (127 mm)	5	CSGPPP5	50/55	330/360		23/108	8/12	20/30	6/9	0.14
6 in. (152 mm)	6**	CSGPPP6	45/55	400/500		23/153	10/15	25/35	5/7	0.17
8 in. (203 mm)	6**	CSGPPP6	55/65	450/500		23/153	10/15	25/35	4/6	0.18
10 in. (254 mm)	7**	CSGPPP7	55/65	450/500		23/153	8/12	25/35	3/5	0.34

## Victor Series 1 Type HPP



- Heavy preheat
- Scrap and bevel
- Hand and machine cutting

Metal Thickness	Size	Part No.	Cutting Oxygen *** (psig)	Cutting Oxygen (SCFH)	Preheat Oxygen * (psig)	Preheat Oxygen (SCFH)	Fuel (psig)	Fuel **** (SCFH)	Speed ipm	Kerf Width
1/2 in. (12.7 mm)	0	0333-0282	30/35	70/80	REFERENCE PREHEAT CHART ON PAGE 142	44/240	3/5	22/110	18/22	0.06
3/4 in. (19.1 mm)	1	0333-0283	30/35	70/80		44/240	3/6	22/110	15/20	0.08
1 in. (25.4 mm)	2	0333-0284	35/40	115/125		44/240	3/6	22/110	14/18	0.09
1 1/2 in. (38.1 mm)	2	0333-0284	40/45	125/135		44/240	4/8	22/110	12/16	0.09
2 in. (50.8 mm)	3	0333-0285	40/45	150/175		44/240	4/8	22/110	10/14	0.10
2 1/2 in. (63.5 mm)	3	0333-0285	45/50	175/200		44/240	5/9	22/110	9/12	0.10
3 in. (76.2 mm)	4	0333-0286	40/50	210/250		44/240	6/9	22/110	8/11	0.12
4 in. (102 mm)	5	0333-0287	45/55	300/360		44/240	6/9	22/110	7/10	0.14
5 in. (127 mm)	5	0333-0287	50/55	330/360		44/240	6/10	22/110	6/9	0.14
6 in. (152 mm)	6**	0333-0288	45/55	400/500		44/240	6/10	22/110	5/7	0.17
8 in. (203 mm)	6**	0333-0288	55/65	450/500		44/240	8/12	22/110	4/6	0.18
12 in. (305 mm)	8**	0333-0290	60/70	750/850		50/265	10/14	25/120	3/4	0.41
15 in. (381 mm)	10**	0333-0291	45/55	1000/1200		50/265	10/16	25/120	2/4	--
18 in. (457 mm)	12**	0333-0292	45/55	1150/1350		60/290	10/16	30/130	2/3	--

## G-Series Series 1 Type HPP

Metal Thickness	Size	Part No.	Cutting Oxygen *** (psig)	Cutting Oxygen (SCFH)	Preheat Oxygen * (psig)	Preheat Oxygen (SCFH)	Fuel (psig)	Fuel **** (SCFH)	Speed ipm	Kerf Width
3/4 in. (19.1 mm)	1	CSHPP1	30/35	70/80	REFERENCE PREHEAT CHART ON PAGE 142	44/240	3/6	22/110	15/20	0.08
1 in. (25.4 mm)	2	CSHPP2	35/40	115/125		44/240	3/6	22/110	14/18	0.09
1 1/2 in. (38.1 mm)	2	CSHPP2	40/45	125/135		44/240	4/8	22/110	12/16	0.09
2 in. (50.8 mm)	3	CSHPP3	40/45	150/175		44/240	4/8	22/110	10/14	0.10
2 1/2 in. (63.5 mm)	3	CSHPP3	45/50	175/200		44/240	5/9	22/110	9/12	0.10
3 in. (76.2 mm)	4	CSHPP4	40/50	210/250		44/240	6/9	22/110	8/11	0.12
4 in. (102 mm)	5	CSHPP5	45/55	300/360		44/240	6/9	22/110	7/10	0.14
5 in. (127 mm)	5	CSHPP5	50/55	330/360		44/240	6/10	22/110	6/9	0.14
6 in. (152 mm)	6**	CSHPP6	45/55	400/500		44/240	6/10	22/110	5/7	0.17
8 in. (203 mm)	6**	CSHPP6	55/65	450/500		44/240	8/12	22/110	4/6	0.18
10 in. (254 mm)	7**	CSHPP7	55/65	450/500		23/153	5/12	25/35	3/5	0.34
12 in. (305 mm)	8**	CSHPP8	60/70	750/850		50/265	10/14	25/120	3/4	0.41

CUTTING TIPS

Data compiled using mild steel as test material.

\*Applicable for three hose machine torch only. With a two hose cutting torch, preheat pressure is set by the cutting oxygen.

\*\*For best results use ST 2600FC series torches and 3/8 in. hose when using tip size 6 or larger.

\*\*\*All pressures are measured at the regulator using 25 ft x 1/4 in. hose through tip size 5 and 25 ft x 3/8 in. hose for tip size 6 and larger.

\*\*\*\*Oxygen consumption is 1.1 times the acetylene under neutral flame conditions.

## Victor Series 1 Type MTHP



- High speed machines cutting up to 8 in. (203.2 mm)
- Two-piece
- Medium preheat

Metal Thickness	Size	Part No.	Cutting Oxygen *** (psig)	Cutting Oxygen (SCFH)	Preheat Oxygen * (psig)	Preheat Oxygen (SCFH)	Fuel (psig)	Fuel **** (SCFH)	Speed ipm	Kerf Width
1/4 in. (6.4 mm)	00	0333-0352	85/95	68/75	30/35	23/140	8 oz +	12/65	23/30	0.05
3/8 in. (9.5 mm)	00	0333-0352	85/95	68/75	30/35	23/140	8 oz +	12/65	22/29	0.05
1/2 in. (12.7 mm)	0	0333-0353	85/95	110/120	30/35	23/140	8 oz +	12/65	20/28	0.06
3/4 in. (19.1 mm)	0	0333-0353	85/95	110/120	30/35	23/140	8 oz +	12/65	18/26	0.06
1 in. (25.4 mm)	1	0333-0354	85/95	145/160	30/35	23/140	8 oz +	12/65	17/24	0.07
1 1/4 in. (31.75 mm)	1	0333-0354	85/95	145/160	30/35	23/140	8 oz +	12/65	16/20	0.07
1 1/2 in. (38.1 mm)	1	0333-0354	85/95	145/160	30/35	23/140	8 oz +	12/65	12/16	0.07
1 1/2 in. (38.1 mm)	2	0333-0355	85/95	230/250	30/35	23/140	8 oz +	12/65	11/15	0.09
2 in. (50.8 mm)	2	0333-0355	85/95	230/250	30/35	23/140	8 oz +	12/65	10/13	0.09
2 1/2 in. (63.5 mm)	2	0333-0355	85/95	230/250	30/35	23/140	8 oz +	12/65	9/11	0.09
3 in. (76.2 mm)	3	0333-0356	85/95	285/320	30/35	23/140	8 oz +	12/65	7/10	0.11
4 in. (102 mm)	3	0333-0356	85/95	285/320	30/35	23/140	8 oz +	12/65	6/8	0.11
5 in. (127 mm)	3	0333-0356	85/95	285/320	30/35	23/140	8 oz +	12/65	5/7	0.11
6 in. (152 mm)	4	0333-0357	85/95	390/450	30/35	23/140	8 oz +	12/65	5/6	0.14
8 in. (203 mm)	4	0333-0357	85/95	390/450	30/35	23/140	8 oz +	12/65	4/6	0.14
9 in. (228.6 mm)	5	0333-0358	85/95	670/720	30/35	23/140	8 oz +	12/65	4/5	0.18
10 in. (254 mm)	5	0333-0358	85/95	670/720	30/35	23/140	8 oz +	12/65	3/5	0.18

## G-Series Series 1 Type MTHP

Metal Thickness	Size	Part No.	Cutting Oxygen *** (psig)	Cutting Oxygen (SCFH)	Preheat Oxygen * (psig)	Preheat Oxygen (SCFH)	Fuel (psig)	Fuel **** (SCFH)	Speed ipm	Kerf Width
1/4 in. (6.4 mm)	00	CSMTHP00	85/95	68/75	30/35	23/140	8 oz +	12/65	23/30	0.05
3/8 in. (9.5 mm)	00	CSMTHP00	85/95	68/75	30/35	23/140	8 oz +	12/65	22/29	0.05
1/2 in. (12.7 mm)	0	CSMTHP0	85/95	110/120	30/35	23/140	8 oz +	12/65	20/28	0.06
3/4 in. (19.1 mm)	0	CSMTHP0	85/95	110/120	30/35	23/140	8 oz +	12/65	18/26	0.06
1 in. (25.4 mm)	1	CSMTHP1	85/95	145/160	30/35	23/140	8 oz +	12/65	17/24	0.07
1 1/4 in. (31.75 mm)	1	CSMTHP1	85/95	145/160	30/35	23/140	8 oz +	12/65	16/20	0.07
1 1/2 in. (38.1 mm)	1	CSMTHP1	85/95	145/160	30/35	23/140	8 oz +	12/65	12/16	0.07
1 1/2 in. (38.1 mm)	2	CSMTHP2	85/95	230/250	30/35	23/140	8 oz +	12/65	11/15	0.09
2 in. (50.8 mm)	2	CSMTHP2	85/95	230/250	30/35	23/140	8 oz +	12/65	10/13	0.09
2 1/2 in. (63.5 mm)	2	CSMTHP2	85/95	230/250	30/35	23/140	8 oz +	12/65	9/11	0.09
3 in. (76.2 mm)	3	CSMTHP3	85/95	285/320	30/35	23/140	8 oz +	12/65	7/10	0.11
4 in. (102 mm)	3	CSMTHP3	85/95	285/320	30/35	23/140	8 oz +	12/65	6/8	0.11
5 in. (127 mm)	3	CSMTHP3	85/95	285/320	30/35	23/140	8 oz +	12/65	5/7	0.11
6 in. (152 mm)	4	CSMTHP4	85/95	390/450	30/35	23/140	8 oz +	12/65	5/6	0.14
8 in. (203 mm)	4	CSMTHP4	85/95	390/450	30/35	23/140	8 oz +	12/65	4/6	0.14
9 in. (228.6 mm)	5	CSMTHP5	85/95	670/720	30/35	23/140	8 oz +	12/65	4/5	0.18
10 in. (254 mm)	5	CSMTHP5	85/95	670/720	30/35	23/140	8 oz +	12/65	3/5	0.18

Data compiled using mild steel as test material.

\*Applicable for three hose machine torch only. With a two hose cutting torch, preheat pressure is set by the cutting oxygen.

\*\*For best results use ST 2600FC series torches and 3/8 in. hose when using tip size 6 or larger.

\*\*\*All pressures are measured at the regulator using 25 ft x 1/4 in. hose through tip size 5 and 25 ft x 3/8 in. hose for tip size 6 and larger.

\*\*\*\*Oxygen consumption is 1.1 times the acetylene under neutral flame conditions.

## Victor Series 1 Type 303MP



- General purpose
- Hand and machine torch cutting

Metal Thickness	Size	Part No.	Cutting Oxygen (psig) ***	Cutting Oxygen (SCFH)	Preheat Oxygen * (psig)	Preheat Oxygen (SCFH)	Fuel (psig)	Fuel **** (SCFH)	Speed ipm	Kerf Width
1/4 in. (6.4 mm)	00	0330-0187	20/25	22/26	REFERENCE PREHEAT CHART ON PAGE 142	23/108	3/5	5/7	21/25	0.04
3/8 in. (9.5 mm)	0	0330-0188	25/30	45/55		23/108	3/5	8/10	20/24	0.06
1/2 in. (12.7 mm)	0	0330-0188	30/35	50/55		23/108	3/5	8/10	18/22	0.06
3/4 in. (19.1 mm)	1	0330-0189	30/35	70/80		23/108	4/6	10/12	15/20	0.08
1 in. (25.4 mm)	2	0330-0193	35/40	115/125		23/108	4/8	12/15	14/18	0.09
1 1/2 in. (38.1 mm)	2	0330-0193	40/45	125/135		23/108	5/9	12/15	12/16	0.09
2 in. (50.8 mm)	3	0330-0194	40/45	150/175		23/108	5/9	14/18	10/14	0.10
2 1/2 in. (63.5 mm)	3	0330-0194	45/50	175/200		23/108	6/10	14/18	9/12	0.10
3 in. (76.2 mm)	4	0330-0195	45/50	210/250		23/108	8/12	16/20	8/11	0.12
4 in. (102 mm)	5	0330-0196	45/55	300/360		23/108	8/12	20/30	7/10	0.14
5 in. (127 mm)	5	0330-0196	50/55	330/360		23/108	8/12	20/30	6/9	0.14
6 in. (152 mm)	6**	0330-0197	45/55	400/500		23/153	10/15	25/35	5/7	0.17
8 in. (203 mm)	6**	0330-0197	55/65	450/500		23/153	10/15	25/35	4/6	0.18

## G-Series Series 1 Type 303MP

Metal Thickness	Size	Part No.	Cutting Oxygen (psig) ***	Cutting Oxygen (SCFH)	Preheat Oxygen * (psig)	Preheat Oxygen (SCFH)	Fuel (psig)	Fuel **** (SCFH)	Speed ipm	Kerf Width
3/8 in. (9.5 mm)	0	CS1303MP0	25/30	45/55	REFERENCE PREHEAT CHART ON PAGE 142	23/108	3/5	8/10	20/24	0.06
1/2 in. (12.7 mm)	0	CS1303MP0	30/35	50/55		23/108	3/5	8/10	18/22	0.06
3/4 in. (19.1 mm)	1	CS1303MP1	30/35	70/80		23/108	4/6	10/12	15/20	0.08
1 in. (25.4 mm)	2	CS1303MP2	35/40	115/125		23/108	4/8	12/15	14/18	0.09
1 1/2 in. (38.1 mm)	2	CS1303MP2	40/45	125/135		23/108	5/9	12/15	12/16	0.09
2 in. (50.8 mm)	3	CS1303MP3	40/50	150/175		23/108	5/9	14/18	10/14	0.10
2 1/2 in. (63.5 mm)	3	CS1303MP3	45/50	175/200		23/108	6/10	14/18	9/12	0.10
3 in. (76.2 mm)	4	CS1303MP4	45/50	210/250		23/108	8/12	16/20	8/11	0.12
4 in. (102 mm)	5	CS1303MP5	45/55	300/360		23/108	8/12	20/30	7/10	0.14
5 in. (127 mm)	5	CS1303MP5	50/55	330/360		23/108	8/12	20/30	6/9	0.14
6 in. (152 mm)	6**	CS1303MP6	45/55	400/500		23/153	10/15	25/35	5/7	0.17
8 in. (203 mm)	6**	CS1303MP6	55/65	450/500		23/153	10/15	25/35	4/6	0.18

## Victor Series 1 Type BTMP



- High performance
- Bevel cutting

Metal Thickness	Size	Part No.	Cutting Oxygen (psig) ***	Cutting Oxygen (SCFH)	Preheat Oxygen * (psig)	Preheat Oxygen (SCFH)	Fuel (psig)	Fuel **** (SCFH)	Speed ipm	Kerf Width
1 in. (25.4 mm)	4	0333-0209	60/75	390/450	30/35	23/140	8-10	12/65	10/18	-
1 1/2 in. (38.1 mm)	4	0333-0209	60/75	390/450	30/35	23/140	8-10	12/65	8/16	-
2 in. (50.8 mm)	4	0333-0209	60/75	390/450	30/35	23/140	8-10	12/65	6/14	-
2 1/2 in. (63.5 mm)	4	0333-0209	60/75	390/450	30/35	23/140	8-10	12/65	5/12	-
3 in. (76.2 mm)	5	0333-0210	60/75	670/720	30/35	23/140	8-12	12/65	6/11	-
3 1/2 in. (89 mm)	5	0333-0210	60/75	670/720	30/35	23/140	8-12	12/65	12/65	-
4 in. (102 mm)	5	0333-0210	60/75	670/720	30/35	23/140	8-12	12/65	4/9	-
4 1/2 in. (114.3 mm)	5	0333-0210	60/75	670/720	30/35	23/140	8-12	12/65	4/8	-
5 in. (127 mm)	6	0333-0211	65/85	-	30/35	23/140	8-15	12/65	3/8	-
5 1/2 in. (139.7 mm)	6	0333-0211	65/85	-	30/35	23/140	8-15	12/65	3/7	-
6 in. (152 mm)	6	0333-0211	65/85	-	30/35	23/140	8-15	12/65	3/6	-

Data compiled using a 3 Hose Torch

Data compiled using mild steel as test material.

\*Applicable for three hose machine torch only. With a two hose cutting torch, preheat pressure is set by the cutting oxygen.

\*\*For best results use ST 2600FC series torches and 3/8 in. hose when using tip size 6 or larger.

\*\*\*All pressures are measured at the regulator using 25 ft x 1/4 in. hose through tip size 5 and 25 ft x 3/8 in. hose for tip size 6 and larger.

\*\*\*\*Oxygen consumption is 1.1 times the acetylene under neutral flame conditions.

## Victor Series 1 Type GTB



- Gouging tip (bent)
- Removing welds

Metal Thickness	Size	Part No.	Cutting Oxygen *** (psig)	Cutting Oxygen (SCFH)	Preheat Oxygen * (psig)	Preheat Oxygen (SCFH)	Fuel (psig)	Fuel **** (SCFH)	Speed ipm	Kerf Width
1/4 - 3/4 in. (6.4 - 19.1 mm)	3	0333-0414	30/65	175/200	30/65	23/108	8/10	14/18	–	–
1/4 - 3/4 in. (6.4 - 19.1 mm)	4	0333-0415	30/65	210/250	30/65	23/108	8/10	16/20	–	–

## Victor Series 1 Type 318MP



- General purpose
- Gouging and rivet washing
- Medium preheat

Metal Thickness	Size	Part No.	Cutting Oxygen *** (psig)	Cutting Oxygen (SCFH)	Preheat Oxygen * (psig)	Preheat Oxygen (SCFH)	Fuel (psig)	Fuel **** (SCFH)	Speed ipm	Kerf Width
2 in. (50.8 mm)	3	0330-0333	40/45	150/175	REFERENCE PREHEAT CHART ON PAGE 142	23/108	5/9	14/18	10/14	0.10
2 1/2 in. (63.5 mm)	3	0330-0333	45/50	175/200		23/108	6/10	14/18	9/12	0.10
3 in. (76.2 mm)	4	0330-0335	45/50	210/250		23/108	8/12	16/20	8/11	0.12
6 in. (152 mm)	6**	0330-0336	45/55	400/500		23/153	10/15	25/35	5/7	0.17
8 in. (203 mm)	6**	0330-0336	55/65	450/500		23/153	10/15	25/35	4/6	0.18

## G-Series Series 1 Type 318MP

Metal Thickness	Size	Part No.	Cutting Oxygen *** (psig)	Cutting Oxygen (SCFH)	Preheat Oxygen * (psig)	Preheat Oxygen (SCFH)	Fuel (psig)	Fuel **** (SCFH)	Speed ipm	Kerf Width
1 in. (25.4 mm)	2	CS318MP2	35/40	115/125	REFERENCE PREHEAT CHART ON PAGE 142	44/240	3/6	22/110	14/18	0.09
1 1/2 in. (38.1 mm)	2	CS318MP2	40/45	125/135		44/240	4/8	22/110	12/16	0.09
3 in. (76.2 mm)	4	CS318MP4	40/50	210/250		44/240	6/9	22/110	8/11	0.12
6 in. (152 mm)	6**	CS318MP6	45/55	400/500		44/240	6/10	22/110	5/7	0.17
8 in. (203 mm)	6**	CS318MP6	55/65	450/500		44/240	8/12	22/110	4/6	0.18
12 in. (305 mm)	8**	CS318MP8	60/70	750/850		50/265	10/14	25/120	3/4	0.41



CUTTING TIPS

Data compiled using mild steel as test material.

\*Applicable for three hose machine torch only. With a two hose cutting torch, preheat pressure is set by the cutting oxygen.

\*\*For best results use ST 2600FC series torches and 3/8 in. hose when using tip size 6 or larger.











\*\*\*All pressures are measured at the regulator using 25 ft x 1/4 in. hose through tip size 5 and 25 ft x 3/8 in. hose for tip size 6 and larger.

\*\*\*\*Oxygen consumption is 1.1 times the acetylene under neutral flame conditions.

Series 1 – LP Cutting Tips

LP (Propane / Natural Gas)

Series 1 tip style, fuel gas usage and Victor equipment compatibility shown below

Type		Fuel Gas	Application
200		LP	<ul style="list-style-type: none"> <li>General purpose</li> <li>Hand and machine torch cutting</li> </ul>
207		LP	<ul style="list-style-type: none"> <li>Used for “blowing” rivets</li> <li>Popular with various railroad applications</li> </ul>
244		LP	<ul style="list-style-type: none"> <li>Cutting close to bulk heads</li> <li>Rivet cutting</li> </ul>
MCN		LP	<ul style="list-style-type: none"> <li>For application requiring extra heavy pre-heat and wide kerf</li> </ul>
GPN		LP	<ul style="list-style-type: none"> <li>General purpose</li> <li>Hand and machine torch cutting</li> </ul>
MTHN		LP	<ul style="list-style-type: none"> <li>High speed machine cutting through 10" (252 mm)</li> </ul>
HPN		LP	<ul style="list-style-type: none"> <li>Heavy preheat for scrap, bevel and other heavy preheat requirements</li> </ul>
BTN		LP	<ul style="list-style-type: none"> <li>Heavy performance bevel cutting for use with mild steel HSLA, T1 and HV-80</li> </ul>
CSN		LP	<ul style="list-style-type: none"> <li>A coarse splined scrap cutting tip for use with natural gas</li> </ul>
GTB		LP	<ul style="list-style-type: none"> <li>Gouging tip (bent)</li> <li>Removal of welds</li> </ul>

Tip packaging is color coded with reference to fuel gas usage. Other special application tips available. Contact Technical Services at 1-800-426-1888

CUTTING TIPS





## Victor Series 1 Type 200



- General purpose
- Hand and machine torch cutting

Metal Thickness	Size	Part No.	Cutting Oxygen *** (psig)	Cutting Oxygen (SCFH)	Preheat Oxygen * (psig)	Preheat Oxygen (SCFH)	Fuel (psig)	Fuel **** (SCFH)	Speed ipm	Kerf Width
3/4 in. (19.1 mm)	1	0330-0144	30/35	70/80	REFERENCE PREHEAT CHART ON PAGE 142	23/108	4/6	10/12	15/20	0.08
1 in. (25.4 mm)	2	0330-0145	35/40	115/125		23/108	4/8	12/15	14/18	0.09
1 1/2 in. (38.1 mm)	2	0330-0145	40/45	125/135		23/108	5/9	12/15	12/16	0.09
2 in. (50.8 mm)	3	0330-0146	40/50	150/175		23/108	5/9	14/18	10/14	0.10
2 1/2 in. (63.5 mm)	3	0330-0146	45/50	175/200		23/108	6/10	14/18	9/12	0.10
3 in. (76.2 mm)	4	0330-0147	45/50	210/250		23/108	8/12	16/20	8/11	0.12
4 in. (102 mm)	5	0330-0148	45/55	300/360		23/108	8/12	20/30	7/10	0.14
5 in. (127 mm)	5	0330-0148	50/55	330/360		23/108	8/12	20/30	6/9	0.14
6 in. (152 mm)	6**	0330-0149	45/55	400/500		23/153	10/15	25/35	5/7	0.17
8 in. (203 mm)	6**	0330-0149	55/65	450/500		23/153	10/15	25/35	4/6	0.18

## Victor Series 1 Type 207



- Used for “blowing” rivets
- Popular with various railroad applications

Metal Thickness	Size	Part No.	Cutting Oxygen *** (psig)	Cutting Oxygen (SCFH)	Preheat Oxygen * (psig)	Preheat Oxygen (SCFH)	Fuel (psig)	Fuel **** (SCFH)	Speed ipm	Kerf Width
3 in. (76.2 mm)	4	0330-0166	40/50	210/250	REFERENCE PREHEAT CHART ON PAGE 141	44/240	6/9	22/110	8/11	0.12

## Victor Series 1 Type 244



- Cutting close to bulk heads
- Rivet cutting

Metal Thickness	Size	Part No.	Cutting Oxygen *** (psig)	Cutting Oxygen (SCFH)	Preheat Oxygen * (psig)	Preheat Oxygen (SCFH)	Fuel (psig)	Fuel **** (SCFH)	Speed ipm	Kerf Width
1 in. (25.4 mm)	2	0330-0344	35/40	115/125	REFERENCE PREHEAT CHART ON PAGE 142	44/240	3/6	22/110	14/18	0.09
1 1/2 in. (38.1 mm)	2	0330-0344	40/45	125/135		44/240	4/8	22/110	12/16	0.09

## Victor Series 1 Type MCN



- Extra heavy preheat
- Wide kerf

Metal Thickness	Size	Part No.	Cutting Oxygen *** (psig)	Cutting Oxygen (SCFH)	Preheat Oxygen * (psig)	Preheat Oxygen (SCFH)	Fuel (psig)	Fuel **** (SCFH)	Speed ipm	Kerf Width
6 in. (152 mm)	6**	0330-0543	45/55	400/500	REFERENCE PREHEAT CHART ON PAGE 142	44/240	6/10	22/110	5/7	0.17
8 in. (203 mm)	6**	0330-0543	55/65	450/500		44/240	8/12	22/110	4/6	0.18

Data compiled using mild steel as test material.

\*Applicable for three hose machine torch only. With a two hose cutting torch, preheat pressure is set by the cutting oxygen.

\*\*For best results use ST 2600FC series torches and 3/8 in. hose when using tip size 6 or larger.

\*\*\*All pressures are measured at the regulator using 25 ft x 1/4 in. hose through tip size 5 and 25 ft x 3/8 in. hose for tip size 6 and larger.

\*\*\*\*Oxygen consumption is 1.1 times the acetylene under neutral flame conditions.

## Victor Series 1 Type GPN



- General purpose
- Hand and machine cutting

Metal Thickness	Size	Part No.	Cutting Oxygen *** (psig)	Cutting Oxygen (SCFH)	Preheat Oxygen * (psig)	Preheat Oxygen (SCFH)	Fuel (psig)	Fuel **** (SCFH)	Speed ipm	Kerf Width
1/8 in. (3.2 mm)	000	0333-0300	20/25	12/14	REFERENCE PREHEAT CHART ON PAGE 142	23/108	3/5	5/6	24/28	0.04
1/4 in. (6.4 mm)	00	0333-0301	20/25	22/.26		23/108	3/5	5/7	21/25	0.04
3/8 in. (9.5 mm)	0	0333-0302	25/30	45/55		23/108	3/5	8/10	20/24	0.06
3/8 in. (9.5 mm)	0	0387-0172#	25/30	45/55		23/108	3/5	8/10	20/24	0.06
1/2 in. (12.7 mm)	0	0333-0302	30/35	50/55		23/108	3/5	8/10	18/22	0.06
1/2 in. (12.7 mm)	0	0387-0172#	30/35	50/55		23/108	3/5	8/10	18/22	0.06
3/4 in. (19.1 mm)	1	0333-0303	30/35	70/80		23/108	4/6	10/12	15/20	0.08
3/4 in. (19.1 mm)	1	0387-0173#	30/35	70/80		23/108	4/6	10/12	15/20	0.08
1 in. (25.4 mm)	2	0333-0304	35/40	115/125		23/108	4/8	12/15	14/18	0.09
1 in. (25.4 mm)	2	0387-0174#	35/40	115/125		23/108	4/8	12/15	14/18	0.09
1 1/2 in. (38.1 mm)	2	0333-0304	40/45	125/135		23/108	5/9	12/15	12/16	0.09
1 1/2 in. (38.1 mm)	2	0387-0174#	40/45	125/135		23/108	5/9	12/15	12/16	0.09
2 in. (50.8 mm)	3	0333-0305	40/50	150/175		23/108	5/9	14/18	10/14	0.10
2 1/2 in. (63.5 mm)	3	0333-0305	45/50	175/200		23/108	6/10	14/18	9/12	0.10
3 in. (76.2 mm)	4	0333-0306	45/50	210/250		23/108	8/12	16/20	8/11	0.12
4 in. (102 mm)	5	0333-0307	45/55	300/360		23/108	8/12	20/30	7/10	0.14
5 in. (127 mm)	5	0333-0307	50/55	330/360		23/108	8/12	20/30	6/9	0.14
6 in. (152 mm)	6**	0333-0308	45/55	400/500		23/153	10/15	25/35	5/7	0.17
8 in. (203 mm)	6**	0333-0308	55/65	450/500	23/153	10/15	25/35	4/6	0.18	
10 in. (254 mm)	7**	0333-0309	55/65	450/500	23/153	8/12	25/35	3/5	0.34	
12 in. (305 mm)	8**	0333-0310	60/70	450/500	23/153	10/14	25/35	3/4	0.41	

## G-Series Series 1 Type GPN

Metal Thickness	Size	Part No.	Cutting Oxygen *** (psig)	Cutting Oxygen (SCFH)	Preheat Oxygen * (psig)	Preheat Oxygen (SCFH)	Fuel (psig)	Fuel **** (SCFH)	Speed ipm	Kerf Width
1/8 in. (3.2 mm)	000	CSGPN000	20/25	12/14	REFERENCE PREHEAT CHART ON PAGE 142	23/108	3/5	5/6	24/28	0.04
1/4 in. (6.4 mm)	00	CSGPN00	20/25	22/.26		23/108	3/5	5/7	21/25	0.04
3/8 in. (9.5 mm)	0	CSGPN0	25/30	45/55		23/108	3/5	8/10	20/24	0.06
1/2 in. (12.7 mm)	0	CSGPN00	30/35	50/55		23/108	3/5	8/10	18/22	0.06
3/4 in. (19.1 mm)	1	CSGPN1	30/35	70/80		23/108	4/6	10/12	15/20	0.08
1 in. (25.4 mm)	2	CSGPN2	35/40	115/125		23/108	4/8	12/15	14/18	0.09
1 1/2 in. (38.1 mm)	2	CSGPN2	40/45	125/135		23/108	5/9	12/15	12/16	0.09
2 in. (50.8 mm)	3	CSGPN3	40/50	150/175		23/108	5/9	14/18	10/14	0.10
2 1/2 in. (63.5 mm)	3	CSGPN3	45/50	175/200		23/108	6/10	14/18	9/12	0.10
3 in. (76.2 mm)	4	CSGPN4	45/50	210/250		23/108	8/12	16/20	8/11	0.12
4 in. (102 mm)	5	CSGPN5	45/55	300/360		23/108	8/12	20/30	7/10	0.14
5 in. (127 mm)	5	CSGPN5	50/55	330/360		23/108	8/12	20/30	6/9	0.14
6 in. (152 mm)	6**	CSGPN6	45/55	400/500		23/153	10/15	25/35	5/7	0.17
8 in. (203 mm)	6**	CSGPN6	55/65	450/500		23/153	10/15	25/35	4/6	0.18
10 in. (254 mm)	7**	CSGPN7	55/65	450/500		23/153	8/12	25/35	3/5	0.34
12 in. (305 mm)	8**	CSGPN8	60/70	450/500		23/153	10/14	25/35	3/4	0.41

CUTTING TIPS

Data compiled using mild steel as test material.

\*Applicable for three hose machine torch only. With a two hose cutting torch, preheat pressure is set by the cutting oxygen.

\*\*For best results use ST 2600FC series torches and 3/8 in. hose when using tip size 6 or larger.

\*\*\*All pressures are measured at the regulator using 25 ft x 1/4 in. hose through tip size 5 and 25 ft x 3/8 in. hose for tip size 6 and larger.

\*\*\*\*Oxygen consumption is 1.1 times the acetylene under neutral flame conditions.

## G-Series Series 1 Type GPN (Plated)



- General purpose
- Hand and machine cutting
- Two-piece
- Medium preheat

Metal Thickness	Size	Part No.	Cutting Oxygen *** (psig)	Cutting Oxygen (SCFH)	Preheat Oxygen * (psig)	Preheat Oxygen (SCFH)	Fuel (psig)	Fuel **** (SCFH)	Speed ipm	Kerf Width
1/8 in. (3.2 mm)	000	CSGPNP000	20/25	12/14	REFERENCE PREHEAT CHART ON PAGE 142	23/108	3/5	5/6	24/28	0.04
1/4 in. (6.4 mm)	00	CSGPNP00	20/25	22/26		23/108	3/5	5/7	21/25	0.04
3/8 in. (9.5 mm)	0	CSGPNP0	25/30	45/55		23/108	3/5	8/10	20/24	0.06
1/2 in. (12.7 mm)	0	CSGPNP0	30/35	50/55		23/108	3/5	8/10	18/22	0.06
3/4 in. (19.1 mm)	1	CSGPNP1	30/35	70/80		23/108	4/6	10/12	15/20	0.08
1 in. (25.4 mm)	2	CSGPNP2	35/40	115/125		23/108	4/8	12/15	14/18	0.09
1 1/2 in. (38.1 mm)	2	CSGPNP2	40/45	125/135		23/108	5/9	12/15	12/16	0.09
2 in. (50.8 mm)	3	CSGPNP3	40/50	150/175		23/108	5/9	14/18	10/14	0.10
2 1/2 in. (63.5 mm)	3	CSGPNP3	45/50	175/200		23/108	6/10	14/18	9/12	0.10
3 in. (76.2 mm)	4	CSGPNP4	45/50	210/250		23/108	8/12	16/20	8/11	0.12
4 in. (102 mm)	5	CSGPNP5	45/55	300/360		23/108	8/12	20/30	7/10	0.14
5 in. (127 mm)	5	CSGPNP6	50/55	330/360		23/108	8/12	20/30	6/9	0.14
6 in. (152 mm)	6**	CSGPNP6	45/55	400/500		23/153	10/15	25/35	5/7	0.17
8 in. (203 mm)	6**	CSGPNP6	55/65	450/500		23/153	10/15	25/35	4/6	0.18
10 in. (254 mm)	7**	CSGPNP7	55/65	450/500	23/153	8/12	25/35	3/5	0.34	
12 in. (305 mm)	8**	CSGPNP8	60/70	450/500	23/153	10/14	25/35	3/4	0.41	

## Victor Series 1 Type MTHN



- High speed machine cutting through 10 in. (252 mm)

Metal Thickness	Size	Part No.	Cutting Oxygen *** (psig)	Cutting Oxygen (SCFH)	Preheat Oxygen * (psig)	Preheat Oxygen (SCFH)	Fuel (psig)	Fuel **** (SCFH)	Speed ipm	Kerf Width
1/4 in. (6.4 mm)	00	0333-0363	85/95	68/75	30/35	23/140	8 oz +	12/65	23/30	0.05
3/8 in. (9.5 mm)	00	0333-0363	85/95	68/75	30/35	23/140	8 oz +	12/65	22/29	0.05
1/2 in. (12.7 mm)	0	0333-0364	85/95	110/120	30/35	23/140	8 oz +	12/65	20/28	0.06
3/4 in. (19.1 mm)	0	0333-0364	85/95	110/120	30/35	23/140	8 oz +	12/65	18/26	0.06
1 in. (25.4 mm)	1	0333-0365	85/95	145/160	30/35	23/140	8 oz +	12/65	17/24	0.07
1 1/4 in. (31.75 mm)	1	0333-0365	85/95	145/160	30/35	23/140	8 oz +	12/65	16/20	0.07
1 1/2 in. (38.1 mm)	1	0333-0365	85/95	145/160	30/35	23/140	8 oz +	12/65	12/16	0.07
2 in. (50.8 mm)	2	0333-0366	85/95	230/250	30/35	23/140	8 oz +	12/65	11/15	0.09
2 1/2 in. (63.5 mm)	2	0333-0366	85/95	230/250	30/35	23/140	8 oz +	12/65	10/13	0.09
3 in. (76.2 mm)	2	0333-0366	85/95	230/250	30/35	23/140	8 oz +	12/65	9/11	0.09
4 in. (102 mm)	3	0333-0367	85/95	285/320	30/35	23/140	8 oz +	12/65	7/10	0.11
5 in. (127 mm)	3	0333-0367	85/95	285/320	30/35	23/140	8 oz +	12/65	6/8	0.11
6 in. (152 mm)	3	0333-0367	85/95	285/320	30/35	23/140	8 oz +	12/65	5/7	0.11
7 in. (177.8 mm)	4	0333-0368	85/95	390/450	30/35	23/140	8 oz +	12/65	5/6	0.14
8 in. (203 mm)	4	0333-0368	85/95	390/450	30/35	23/140	8 oz +	12/65	4/6	0.14
9 in. (228.6 mm)	5	0333-0369	85/95	670/720	30/35	23/140	8 oz +	12/65	4/5	0.18
10 in. (254 mm)	5	0333-0369	85/95	670/720	30/35	23/140	8 oz +	12/65	3/5	0.18
—	6**	0333-0370	85/95	—	30/35	23/140	8 oz +	12/65	—	—
—	8**	0333-0371	85/95	—	30/35	23/140	8 oz +	12/65	—	—

Data compiled using mild steel as test material.

\*Applicable for three hose machine torch only. With a two hose cutting torch, preheat pressure is set by the cutting oxygen.

\*\*For best results use ST 2600FC series torches and 3/8 in. hose when using tip size 6 or larger.

\*\*\*All pressures are measured at the regulator using 25 ft x 1/4 in. hose through tip size 5 and 25 ft x 3/8 in. hose for tip size 6 and larger.

\*\*\*\*Oxygen consumption is 1.1 times the acetylene under neutral flame conditions.

## G-Series Series 1 Type MTHN



- High speed machine cutting
- Two-piece

Metal Thickness	Size	Part No.	Cutting Oxygen *** (psig)	Cutting Oxygen (SCFH)	Preheat Oxygen * (psig)	Preheat Oxygen (SCFH)	Fuel (psig)	Fuel **** (SCFH)	Speed ipm	Kerf Width
1/4 in. (6.4 mm)	00	CSMTHN00	85/95	68/75	30/35	23/140	8 oz +	12/65	23/30	0.05
3/8 in. (9.5 mm)	00	CSMTHN00	85/95	68/75	30/35	23/140	8 oz +	12/65	22/29	0.05
1/2 in. (12.7 mm)	0	CSMTHN0	85/95	110/120	30/35	23/140	8 oz +	12/65	20/28	0.06
3/4 in. (19.1 mm)	0	CSMTHN0	85/95	110/120	30/35	23/140	8 oz +	12/65	18/26	0.06
1 in. (25.4 mm)	1	CSMTHN1	85/95	145/160	30/35	23/140	8 oz +	12/65	17/24	0.07
1 1/4 in. (31.75 mm)	1	CSMTHN1	85/95	145/160	30/35	23/140	8 oz +	12/65	16/20	0.07
1 1/2 in. (38.1 mm)	1	CSMTHN1	85/95	145/160	30/35	23/140	8 oz +	12/65	12/16	0.07
2 in. (50.8 mm)	2	CSMTHN2	85/95	230/250	30/35	23/140	8 oz +	12/65	11/15	0.09
2 1/2 in. (63.5 mm)	2	CSMTHN2	85/95	230/250	30/35	23/140	8 oz +	12/65	10/13	0.09
3 in. (76.2 mm)	2	CSMTHN2	85/95	230/250	30/35	23/140	8 oz +	12/65	9/11	0.09
4 in. (102 mm)	3	CSMTHN3	85/95	285/320	30/35	23/140	8 oz +	12/65	7/10	0.11
5 in. (127 mm)	3	CSMTHN3	85/95	285/320	30/35	23/140	8 oz +	12/65	6/8	0.11
6 in. (152 mm)	3	CSMTHN3	85/95	285/320	30/35	23/140	8 oz +	12/65	5/7	0.11
7 in. (177.8 mm)	4	CSMTHN4	85/95	390/450	30/35	23/140	8 oz +	12/65	5/6	0.14
8 in. (203 mm)	4	CSMTHN4	85/95	390/450	30/35	23/140	8 oz +	12/65	4/6	0.14
9 in. (228.6 mm)	5	CSMTHN5	85/95	670/720	30/35	23/140	8 oz +	12/65	4/5	0.18
10 in. (254 mm)	5	CSMTHN5	85/95	670/720	30/35	23/140	8 oz +	12/65	3/5	0.18
—	6**	CSMTHN6	85/95	—	30/35	23/140	8 oz +	12/65	—	—

## Victor Series 1 Type HPN



- Heavy preheat
- Strap and bevel

Metal Thickness	Size	Part No.	Cutting Oxygen *** (psig)	Cutting Oxygen (SCFH)	Preheat Oxygen * (psig)	Preheat Oxygen (SCFH)	Fuel (psig)	Fuel **** (SCFH)	Speed ipm	Kerf Width
1/2 in. (12.7 mm)	0	0333-0322	30/35	70/80	REFERENCE PREHEAT CHART ON PAGE 142	44/240	3/5	22/110	18/22	0.06
3/4 in. (19.1 mm)	1	0333-0323	30/35	70/80		44/240	3/6	22/110	15/20	0.08
1 in. (25.4 mm)	2	0333-0324	35/40	115/125		44/240	3/6	22/110	14/18	0.09
1 1/2 in. (38.1 mm)	2	0333-0324	40/45	125/135		44/240	4/8	22/110	12/16	0.09
2 in. (50.8 mm)	3	0333-0325	40/45	150/175		44/240	4/8	22/110	10/14	0.10
2 1/2 in. (63.5 mm)	3	0333-0325	45/50	175/200		44/240	5/9	22/110	9/12	0.10
3 in. (76.2 mm)	4	0333-0326	40/50	210/250		44/240	6/9	22/110	8/11	0.12
4 in. (102 mm)	5	0333-0327	45/55	300/360		44/240	6/9	22/110	7/10	0.14
5 in. (127 mm)	5	0333-0327	50/55	330/360		44/240	6/10	22/110	6/9	0.14
6 in. (152 mm)	6**	0333-0328	45/55	400/500		44/240	6/10	22/110	5/7	0.17
8 in. (203 mm)	6**	0333-0328	55/65	450/500		44/240	8/12	22/110	4/6	0.18
12 in. (305 mm)	8**	0333-0330	60/70	750/850		50/265	10/14	25/120	3/4	0.41
15 in. (381 mm)	10**	0333-0331	45/55	1000/1200		50/265	10/16	25/120	2/4	—
18 in. (457.2 mm)	12**	0333-0332	45/55	1150/1350		60/290	10/16	30/130	2/3	—

Data compiled using mild steel as test material.

\*Applicable for three hose machine torch only. With a two hose cutting torch, preheat pressure is set by the cutting oxygen.

\*\*For best results use ST 2600FC series torches and 3/8 in. hose when using tip size 6 or larger.

\*\*\*All pressures are measured at the regulator using 25 ft x 1/4 in. hose through tip size 5 and 25 ft x 3/8 in. hose for tip size 6 and larger.

\*\*\*\*Oxygen consumption is 1.1 times the acetylene under neutral flame conditions.

## G-Series Series 1 Type HPN



- Hand and machine torch cutting
- Heavy preheat

Metal Thickness	Size	Part No.	Cutting Oxygen *** (psig)	Cutting Oxygen (SCFH)	Preheat Oxygen * (psig)	Preheat Oxygen (SCFH)	Fuel (psig)	Fuel **** (SCFH)	Speed ipm	Kerf Width
3/4 in. (19.1 mm)	1	CSHPN1	30/35	70/80	REFERENCE PREHEAT CHART ON PAGE 142	44/240	3/6	22/110	15/20	0.08
1 in. (25.4 mm)	2	CSMTHN2	35/40	115/125		44/240	3/6	22/110	14/18	0.09
1 1/2 in. (38.1 mm)	2	CSMTHN2	40/45	125/135		44/240	4/8	22/110	12/16	0.09
2 in. (50.8 mm)	3	CSMTHN3	40/45	150/175		44/240	4/8	22/110	10/14	0.10
2 1/2 in. (63.5 mm)	3	CSMTHN3	45/50	175/200		44/240	5/9	22/110	9/12	0.10
3 in. (76.2 mm)	4	CSMTHN4	40/50	210/250		44/240	6/9	22/110	8/11	0.12
4 in. (102 mm)	5	CSMTHN5	45/55	300/360		44/240	6/9	22/110	7/10	0.14
5 in. (127 mm)	5	CSMTHN5	50/55	330/360		44/240	6/10	22/110	6/9	0.14
6 in. (152 mm)	6**	CSMTHN6	45/55	400/500		44/240	6/10	22/110	5/7	0.17
8 in. (203 mm)	6**	CSMTHN6	55/65	450/500		44/240	8/12	22/110	4/6	0.18
10 in. (254 mm)	7	CSMTHN7	55/65	450/500		23/153	8/12	25/35	3/5	0.34
12 in. (305 mm)	8**	CSMTHN8	60/70	750/850		50/265	10/14	25/120	3/4	0.41
15 in. (381 mm)	10**	CSMTHN10	45/55	1000/1200	50/265	10/16	25/120	2/4	–	
18 in. (457.2 mm)	12**	CSMTHN12	45/55	1150/1350	60/290	10/16	30/130	2/3	–	

## Victor Series 1 Type BTN



- Heavy performance bevel cutting for use with mild steel
- HSLA, T1 and HY-80

Metal Thickness	Size	Part No.	Cutting Oxygen *** (psig)	Cutting Oxygen (SCFH)	Preheat Oxygen * (psig)	Preheat Oxygen (SCFH)	Fuel (psig)	Fuel **** (SCFH)	Speed ipm	Kerf Width
1 in. (25.4 mm)	4	0333-0206	60/75	390/450	30/35	23/140	8-10	12/65	10/18	–
1 1/2 in. (38.1 mm)	4	0333-0206	60/75	390/450	30/35	23/140	8-10	12/65	8/16	–
2 in. (50.8 mm)	4	0333-0206	60/75	390/450	30/35	23/140	8-10	12/65	6/14	–
2 1/2 in. (63.5 mm)	4	0333-0206	60/75	390/450	30/35	23/140	8-10	12/65	5/12	–
3 in. (76.2 mm)	5	0333-0207	60/75	670/720	30/35	23/140	8-12	12/65	6/11	–
3 1/2 in. (89 mm)	5	0333-0207	60/75	670/720	30/35	23/140	8-12	12/65	12/65	–
4 in. (102 mm)	5	0333-0207	60/75	670/720	30/35	23/140	8-12	12/65	4/9	–
4 1/2 in. (114.3 mm)	5	0333-0207	60/75	670/720	30/35	23/140	8-12	12/65	4/8	–
5 in. (127 mm)	6	0333-0208	65/85	–	30/35	23/140	8-15	12/65	3/8	–
5 1/2 in. (139.7 mm)	6	0333-0208	65/85	–	30/35	23/140	8-15	12/65	3/7	–
6 in. (152 mm)	6	0333-0208	65/85	–	30/35	23/140	8-15	12/65	3/6	–

Data compiled using a 3 Hose Torch

## Victor Series 1 Type CSN



- A coarse splined scrap cutting tip
- Use with natural gas

Metal Thickness	Size	Part No.	Cutting Oxygen *** (psig)	Cutting Oxygen (SCFH)	Preheat Oxygen * (psig)	Preheat Oxygen (SCFH)	Fuel (psig)	Fuel **** (SCFH)	Speed ipm	Kerf Width
12 in. (305 mm)	8	0333-0411	60/70	750/850	REFERENCE PREHEAT CHART ON PAGE 142	50/265	10/14	25/120	3/4	0.41

Data compiled using mild steel as test material.

\*Applicable for three hose machine torch only. With a two hose cutting torch, preheat pressure is set by the cutting oxygen.

\*\*For best results use ST 2600FC series torches and 3/8 in. hose when using tip size 6 or larger.

\*\*\*All pressures are measured at the regulator using 25 ft x 1/4 in. hose through tip size 5 and 25 ft x 3/8 in. hose for tip size 6 and larger.

\*\*\*\*Oxygen consumption is 1.1 times the acetylene under neutral flame conditions.

## Series 3 – Cutting Tips

Series 3 tip style, fuel gas usage and Victor equipment compatibility shown below.

### Cutting Torches

Handle	Cutting Attachment	Fuel Gas
<b>Heavy Duty</b>		
315FC	CA 2460-90°	All
<b>Medium Duty</b>		
100FC	CA 1350-90°, CA 1351-75°, CA 1352-180°	All
<b>Light Duty</b>		
J-40	CA 1260-90°	All
<b>Straight Torches</b>		
CST 800FC	–	All

### Material Thickness – Tip Size

Material Thickness		Tip Size
Inches	mm	
1/8 in.	3.2 mm	000
1/4 in.	6.4 mm	00
3/8 in. – 1/2 in.	9.5 - 12.7 mm	0
3/4 in.	19.1 mm	1
1 in. – 1 1/2 in.	25.4 - 38.1 mm	2
2 in. – 2 1/2 in.	50.8 - 63.5 mm	3
3 in.	76.2 mm	4
4 in. – 5 in.	102 - 127 mm	5

## Series 3 – Acetylene Cutting Tips

### Victor Series 3 Type 101



- General purpose
- Hand and machine torch cutting

Metal Thickness	Size	Part No.	Cutting Oxygen *** (psig)	Cutting Oxygen (SCFH)	Preheat Oxygen * (psig)	Preheat Oxygen (SCFH)	Acetylene (psig)	Acetylene ****(SCFH)	Speed ipm	Kerf Width
1/8 in. (3.2 mm)	000	0331-0002	20 / 25	20 / 25	3 / 5	3 / 5	3 / 5	3 / 5	28 / 32	.04
1/4 in. (6.4 mm)	00	0331-0009	20 / 25	30 / 35	3 / 5	4 / 6	3 / 5	4 / 6	27 / 30	.05
1/4 in. (6.4 mm)	00	0387-0144#	20 / 25	30 / 35	3 / 5	4 / 6	3 / 5	4 / 6	27 / 30	.05
3/8 in. (9.5 mm)	0	0331-0013	25 / 30	55 / 60	3 / 5	5 / 9	3 / 5	5 / 8	24 / 28	.06
3/8 in. (9.5 mm)	0	0387-0145#	25 / 30	55 / 60	3 / 5	5 / 9	3 / 5	5 / 8	24 / 28	.06
1/2 in. (12.7 mm)	0	0331-0013	30 / 35	60 / 65	3 / 6	7 / 11	3 / 5	6 / 10	20 / 24	.06
1/2 in. (12.7 mm)	0	0387-0145#	30 / 35	60 / 65	3 / 6	7 / 11	3 / 5	6 / 10	20 / 24	.06
3/4 in. (19.1 mm)	1	0331-0014	30 / 35	80 / 85	4 / 7	9 / 14	3 / 5	8 / 13	17 / 21	.07
3/4 in. (19.1 mm)	1	0387-0146#	30 / 35	80 / 85	4 / 7	9 / 14	3 / 5	8 / 13	17 / 21	.07
1 in. (25.4 mm)	2	0331-0015	35 / 40	140 / 150	4 / 9	11 / 18	3 / 6	10 / 16	15 / 19	.09
1 in. (25.4 mm)	2	0387-0147#	35 / 40	140 / 150	4 / 9	11 / 18	3 / 6	10 / 16	15 / 19	.09
1 1/2 in. (38.1 mm)	2	0331-0015	40 / 45	150 / 160	4 / 12	13 / 20	3 / 7	12 / 18	13 / 17	.09
1 1/2 in. (38.1 mm)	2	0387-0147#	40 / 45	150 / 160	4 / 12	13 / 20	3 / 7	12 / 18	13 / 17	.09
2 in. (50.8 mm)	3	0331-0016	40 / 45	210 / 225	5 / 14	15 / 24	4 / 9	14 / 22	12 / 15	.11
2 1/2 in. (63.5 mm)	3	0331-0016	45 / 50	225 / 240	5 / 16	18 / 29	4 / 10	16 / 26	10 / 13	.11
3 in. (76.2 mm)	4	0331-0017	40 / 50	270 / 320	6 / 17	20 / 33	5 / 10	18 / 30	9 / 12	.12
4 in. (102 mm)	5	0331-0018	45 / 55	390 / 425	7 / 18	24 / 37	5 / 12	22 / 34	8 / 11	.15
5 in. (127 mm)	5	0331-0018	50 / 55	425 / 450	7 / 20	29 / 41	5 / 13	26 / 38	7 / 9	.15

### G-Series Series 3 Type 101

Metal Thickness	Size	Part No.	Cutting Oxygen *** (psig)	Cutting Oxygen (SCFH)	Preheat Oxygen * (psig)	Preheat Oxygen (SCFH)	Acetylene (psig)	Acetylene ****(SCFH)	Speed ipm	Kerf Width
1/8 in. (3.2 mm)	000	CS3101000	20 / 25	20 / 25	3 / 5	3 / 5	3 / 5	3 / 5	28 / 32	.04
1/4 in. (6.4 mm)	00	CS310100	20 / 25	30 / 35	3 / 5	4 / 6	3 / 5	4 / 6	27 / 30	.05
3/8 in. (9.5 mm)	0	CS31010	25 / 30	55 / 60	3 / 5	5 / 9	3 / 5	5 / 8	24 / 28	.06
1/2 in. (12.7 mm)	0	CS31010	30 / 35	60 / 65	3 / 6	7 / 11	3 / 5	6 / 10	20 / 24	.06
3/4 in. (19.1 mm)	1	CS31011	30 / 35	80 / 85	4 / 7	9 / 14	3 / 5	8 / 13	17 / 21	.07
1 in. (25.4 mm)	2	CS31012	35 / 40	140 / 150	4 / 9	11 / 18	3 / 6	10 / 16	15 / 19	.09
1 1/2 in. (38.1 mm)	2	CS31012	40 / 45	150 / 160	4 / 12	13 / 20	3 / 7	12 / 18	13 / 17	.09
2 in. (50.8 mm)	3	CS31013	40 / 45	210 / 225	5 / 14	15 / 24	4 / 9	14 / 22	12 / 15	.11
2 1/2 in. (63.5 mm)	3	CS31013	45 / 50	225 / 240	5 / 16	18 / 29	4 / 10	16 / 26	10 / 13	.11
3 in. (76.2 mm)	4	CS31014	40 / 50	270 / 320	6 / 17	20 / 33	5 / 10	18 / 30	9 / 12	.12
4 in. (102 mm)	5	CS31015	45 / 55	390 / 425	7 / 18	24 / 37	5 / 12	22 / 34	8 / 11	.15
5 in. (127 mm)	5	CS31015	50 / 55	425 / 450	7 / 20	29 / 41	5 / 13	26 / 38	7 / 9	.15

Data compiled using mild steel as test material.

\* Applicable for three hose machine torch only. With a two hose cutting torch, preheat pressure is set by the cutting oxygen.

\*\* For best results use ST 2600FC series torches and 3/8 in. hose when using tip size 6 or larger.

\*\*\* All pressures are measured at the regulator using 25 ft x 1/4 in. hose through tip size 5 and 25 ft x 3/8 in. hose for tip size 6 and larger.

\*\*\*\* Oxygen consumption is 1.1 times the acetylene under neutral flame conditions.

**WARNING:** At no time should the withdrawal rate of an individual acetylene cylinder exceed 1/7 of the cylinder contents per hour. If additional flow capacity is required use an acetylene manifold system of sufficient size to supply the necessary volume.

## Victor Series 3 Type 118 (Round)



- Deseaming, scarfing, gouging
- Rivet washing
- Weld preparation

Metal Thickness	Size	Part No.	Cutting Oxygen *** (psig)	Cutting Oxygen (SCFH)	Preheat Oxygen * (psig)	Preheat Oxygen (SCFH)	Acetylene (psig)	Acetylene ****(SCFH)	Speed ipm	Kerf Width
1 in. (25.4 mm)	2	0331-0035	35 / 40	140 / 150	4 / 9	11 / 18	3 / 6	10 / 16	15 / 19	.09
1 1/2 in. (38.1 mm)	2	0331-0035	40 / 45	150 / 160	4 / 12	13 / 20	3 / 7	12 / 18	13 / 17	.09

## G-Series Series 3 Type 118 (Round)

Metal Thickness	Size	Part No.	Cutting Oxygen *** (psig)	Cutting Oxygen (SCFH)	Preheat Oxygen * (psig)	Preheat Oxygen (SCFH)	Acetylene (psig)	Acetylene ****(SCFH)	Speed ipm	Kerf Width
3/8 in. (9.5 mm)	0	CS31180	25 / 30	55 / 60	3 / 5	5 / 9	3 / 5	5 / 8	24 / 28	.06
1/2 in. (12.7 mm)	0	CS31180	30 / 35	60 / 65	3 / 6	7 / 11	3 / 5	6 / 10	20 / 24	.06
1 in. (25.4 mm)	2	CS31181	35 / 40	140 / 150	4 / 9	11 / 18	3 / 6	10 / 16	15 / 19	.09
1 1/2 in. (38.1 mm)	2	CS31181	40 / 45	150 / 160	4 / 12	13 / 20	3 / 7	12 / 18	13 / 17	.09

## Series 3 – Propylene Cutting Tips

### Victor Series 3 Type GPP



- General purpose
- Hand and machine torch cutting

Metal Thickness	Size	Part No.	Cutting Oxygen *** (psig)	Cutting Oxygen (SCFH)	Preheat Oxygen * (psig)	Preheat Oxygen (SCFH)	Acetylene (psig)	Acetylene ****(SCFH)	Speed ipm	Kerf Width
1/4 in. (6.4 mm)	00	0333-0389	20/25	22/.26	REFERENCE PREHEAT CHART ON PAGE 142	23/108	3/5	5/7	21/25	0.04
3/8 in. (9.5 mm)	0	0333-0390	25/30	45/55		23/108	3/5	8/10	20/24	0.06
1/2 in. (12.7 mm)	0	0333-0390	30/35	50/55		23/108	3/5	8/10	18/22	0.06
3/4 in. (19.1 mm)	1	0333-0391	30/35	70/80		23/108	4/6	10/12	15/20	0.08
1 in. (25.4 mm)	2	0333-0392	35/40	115/125		23/108	4/8	12/15	14/18	0.09
1 1/2 in. (38.1 mm)	2	0333-0392	40/45	125/135		23/108	5/9	12/15	12/16	0.09
2 in. (50.8 mm)	3	0333-0393	40/50	150/175		23/108	5/9	14/18	10/14	0.10
2 1/2 in. (63.5 mm)	3	0333-0393	45/50	175/200		23/108	6/10	14/18	9/12	0.10
3 in. (76.2 mm)	4	0333-0394	45/50	210/250		23/108	8/12	16/20	8/11	0.12

### G-Series Series 3 Type GPP

Metal Thickness	Size	Part No.	Cutting Oxygen *** (psig)	Cutting Oxygen (SCFH)	Preheat Oxygen * (psig)	Preheat Oxygen (SCFH)	Acetylene (psig)	Acetylene ****(SCFH)	Speed ipm	Kerf Width
1/8 in. (3.2 mm)	000	CS3GPP000	20/25	12/14	REFERENCE PREHEAT CHART ON PAGE 142	23/108	3/5	5/6	24/28	0.04
1/4 in. (6.4 mm)	00	CS3GPP00	20/25	22/.26		23/108	3/5	5/7	21/25	0.04
3/8 in. (9.5 mm)	0	CS3GPP0	25/30	45/55		23/108	3/5	8/10	20/24	0.06
1/2 in. (12.7 mm)	0	CS3GPP0	30/35	50/55		23/108	3/5	8/10	18/22	0.06
3/4 in. (19.1 mm)	1	CS3GPP1	30/35	70/80		23/108	4/6	10/12	15/20	0.08
1 in. (25.4 mm)	2	CS3GPP2	35/40	115/125		23/108	4/8	12/15	14/18	0.09
1 1/2 in. (38.1 mm)	2	CS3GPP2	40/45	125/135		23/108	5/9	12/15	12/16	0.09
2 in. (50.8 mm)	3	CS3GPP3	40/45	150/175		23/108	5/9	14/18	10/14	0.10
2 1/2 in. (63.5 mm)	3	CS3GPP3	45/50	175/200		23/108	6/10	14/18	9/12	0.10
3 in. (76.2 mm)	4	CS3GPP4	45/50	210/250		23/108	8/12	16/20	8/11	0.12

Data compiled using mild steel as test material.

\* Applicable for three hose machine torch only. With a two hose cutting torch, preheat pressure is set by the cutting oxygen.

\*\* For best results use ST 2600FC series torches and 3/8 in. hose when using tip size 6 or larger.

\*\*\* All pressures are measured at the regulator using 25 ft x 1/4 in. hose through tip size 5 and 25 ft x 3/8 in. hose for tip size 6 and larger.

\*\*\*\* Oxygen consumption is 1.1 times the acetylene under neutral flame conditions.

**WARNING:** At no time should the withdrawal rate of an individual acetylene cylinder exceed 1/7 of the cylinder contents per hour. If additional flow capacity is required use an acetylene manifold system of sufficient size to supply the necessary volume.

**G-Series Series 3 Type 318MP**



- General purpose
- Gouging and rivet washing

Metal Thickness	Size	Part No.	Cutting Oxygen *** (psig)	Cutting Oxygen (SCFH)	Preheat Oxygen * (psig)	Preheat Oxygen (SCFH)	Acetylene (psig)	Acetylene ****(SCFH)	Speed ipm	Kerf Width
1 in. (25.4 mm)	2	CS3318MP2	35/40	115/125	REFERENCE PREHEAT CHART ON PAGE 142	44/240	3/6	22/110	14/18	0.09
1 1/2 in. (38.1 mm)	2	CS3318MP2	40/45	125/135		44/240	4/8	22/110	12/16	0.09
3 in. (76.2 mm)	4	CS3318MP4	40/50	210/250		44/240	6/9	22/110	8/11	0.12
6 in. (152 mm)	6**	CS3318MP6	45/55	400/500		44/240	6/10	22/110	5/7	0.17
8 in. (203 mm)	6**	CS3318MP6	55/65	450/500		44/240	8/12	22/110	4/6	0.18
12 in. (305 mm)	8**	CS3318MP8	60/70	750/850		50/265	10/14	25/120	3/4	0.41

**Series 3 – LP (Propane / Natural Gas) Cutting Tips**

**Victor Series 3 Type GPN**



- General purpose
- Hand and machine cutting

Metal Thickness	Size	Part No.	Cutting Oxygen *** (psig)	Cutting Oxygen (SCFH)	Preheat Oxygen * (psig)	Preheat Oxygen (SCFH)	Acetylene (psig)	Acetylene ****(SCFH)	Speed ipm	Kerf Width
1/4 in. (6.4 mm)	00	0333-0398	20/25	22/26	REFERENCE PREHEAT CHART ON PAGE 142	23/108	3/5	5/7	21/25	0.04
1/4 in. (6.4 mm)	00	0387-0182#	20/25	22/26		23/108	3/5	5/7	21/25	0.04
3/8 in. (9.5 mm)	0	0333-0399	25/30	45/55		23/108	3/5	8/10	20/24	0.06
1/2 in. (12.7 mm)	0	0333-0399	30/35	50/55		23/108	3/5	8/10	18/22	0.06
3/4 in. (19.1 mm)	1	0333-0400	30/35	70/80		23/108	4/6	10/12	15/20	0.08
3/4 in. (19.1 mm)	1	0387-0184#	30/35	70/80		23/108	4/6	10/12	15/20	0.08
1 in. (25.4 mm)	2	0333-0401	35/40	115/125		23/108	4/8	12/15	14/18	0.09
1 in. (25.4 mm)	2	0387-0185#	35/40	115/125		23/108	4/8	12/15	14/18	0.09
1 1/2 in. (38.1 mm)	2	0333-0402	40/45	125/135		23/108	5/9	12/15	12/16	0.09
1 1/2 in. (38.1 mm)	2	0387-0185#	40/45	125/135		23/108	5/9	12/15	12/16	0.09
2 in. (50.8 mm)	3	0333-0402	40/50	150/175		23/108	5/9	14/18	10/14	0.10
2 1/2 in. (63.5 mm)	3	0333-0402	45/50	175/200		23/108	6/10	14/18	9/12	0.10
3 in. (76.2 mm)	4	0333-0403	45/50	210/250		23/108	8/12	16/20	8/11	0.12
4 in. (102 mm)	5	0333-0404	45/55	300/360		23/108	8/12	20/30	7/10	0.14
5 in. (127 mm)	5	0333-0404	50/55	330/360		23/108	8/12	20/30	6/9	0.14

**G-Series Series 3 Type GPN**

Metal Thickness	Size	Part No.	Cutting Oxygen *** (psig)	Cutting Oxygen (SCFH)	Preheat Oxygen * (psig)	Preheat Oxygen (SCFH)	Acetylene (psig)	Acetylene ****(SCFH)	Speed ipm	Kerf Width
1/8 in. (3.2 mm)	000	CS3GPN000	20/25	12/14	REFERENCE PREHEAT CHART ON PAGE 142	23/108	3/5	5/6	24/28	0.04
1/4 in. (6.4 mm)	00	CS3GPN00	20/25	22/26		23/108	3/5	5/7	21/25	0.04
3/8 in. (9.5 mm)	0	CS3GPN0	25/30	45/55		23/108	3/5	8/10	20/24	0.06
1/2 in. (12.7 mm)	0	CS3GPN0	30/35	50/55		23/108	3/5	8/10	18/22	0.06
3/4 in. (19.1 mm)	1	CS3GPN1	30/35	70/80		23/108	4/6	10/12	15/20	0.08
1 in. (25.4 mm)	2	CS3GPN2	35/40	115/125		23/108	4/8	12/15	14/18	0.09
1 1/2 in. (38.1 mm)	2	CS3GPN2	40/45	125/135		23/108	5/9	12/15	12/16	0.09
2 in. (50.8 mm)	3	CS3GPN3	40/50	150/175		23/108	5/9	14/18	10/14	0.10
2 1/2 in. (63.5 mm)	3	CS3GPN3	45/50	175/200		23/108	6/10	14/18	9/12	0.10
3 in. (76.2 mm)	4	CS3GPN4	45/50	210/250		23/108	8/12	16/20	8/11	0.12
4 in. (102 mm)	5	CS3GPN5	45/55	300/360		23/108	8/12	20/30	7/10	0.14
5 in. (127 mm)	5	CS3GPN5	50/55	330/360		23/108	8/12	20/30	6/9	0.14

**CUTTING TIPS**

Data compiled using mild steel as test material.

\* Applicable for three hose machine torch only. With a two hose cutting torch, preheat pressure is set by the cutting oxygen.

\*\* For best results use ST 2600FC series torches and 3/8 in. hose when using tip size 6 or larger.

\*\*\* All pressures are measured at the regulator using 25 ft x 1/4 in. hose through tip size 5 and 25 ft x 3/8 in. hose for tip size 6 and larger.

\*\*\*\* Oxygen consumption is 1.1 times the acetylene under neutral flame conditions.



## Flashback Arrestors and Check Valves

Flashback arrestors and reverse flow check valves provide additional protection against flashbacks. Victor recommends the use of these devices whenever possible. Victor add-on flashback arrestors contain both a reverse flow check valve and a flashback arrestor.

Due to the high flow requirements of Victor Heavy Industry torches, it is important to use flashback arrestors that have sufficient flow capacity.

It is important to understand the difference between reverse flow check valves and flashback arrestors.

### Reverse Flow Check Valves:

Helps to prevent the reverse flow of gases from traveling past the check valve.

### Flashback Arrestors:

Prevents a flame from traveling past the flashback arrestor in the event of a flashback.

**NOTE:** The use of both regulator and torch mount flashback arrestors with heavy industry equipment requiring high gas volume is not recommended because it may cause excessive flow restriction. It is always better to place the safety devices at the rear of the torch than at the regulator in order to protect the hose.

### The Flashback Arrestor

Prevents flashback

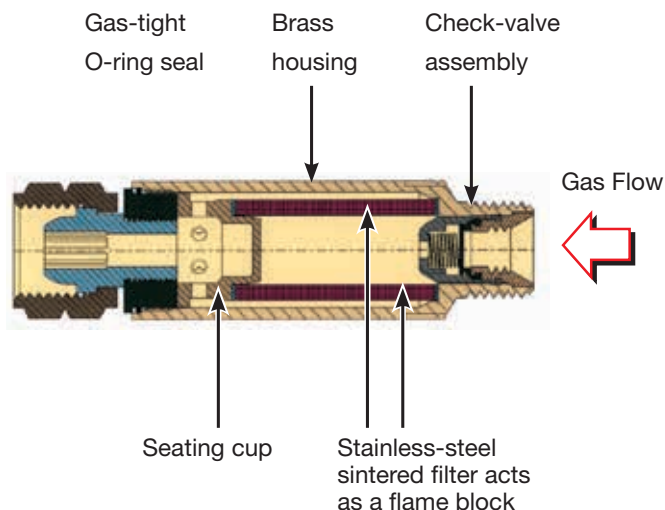

### The Check Valve

Prevents the reverse flow of gases

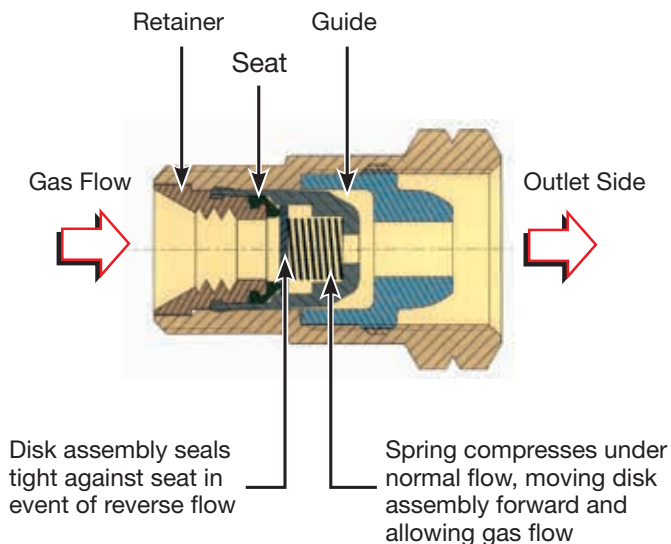

## Conversion Chart

Gas	Conversion Factor	Max. Pressure
Acetylene	1.05	15 psi
Hydrogen	3.79	30 psi
MAP-Pro	0.82	22 psi
Methane	1.34	50 psi
Oxygen	0.95	143 psi
Propane	0.80	50 psi

## FlameBuster™ High Flow

**FBHC-O**  
High Flow Torch Mount



**FBHC-OR**  
High Flow Regulator Mount



**FBHC-OC**  
High Flow Torch Mount



**FBHC-ORC**  
High Flow Regulator Mount



## FlameBuster™

**FB-O**  
Torch Mount - Oxygen



**FB-OR**  
Regulator Mount - Oxygen



**FB-F**  
Torch Mount - Fuel



**FB-FR**  
Regulator Mount - Fuel



**FLOW Chart - FBHC Series Flashback Arrestor**

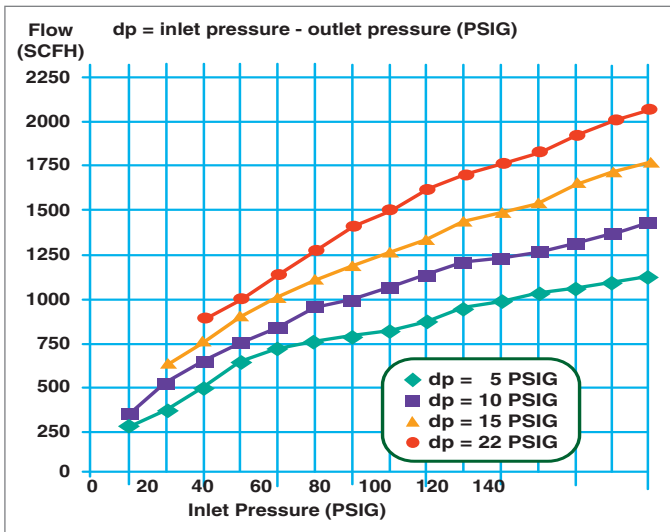

**FLOW Chart - FB Series Flashback Arrestor**

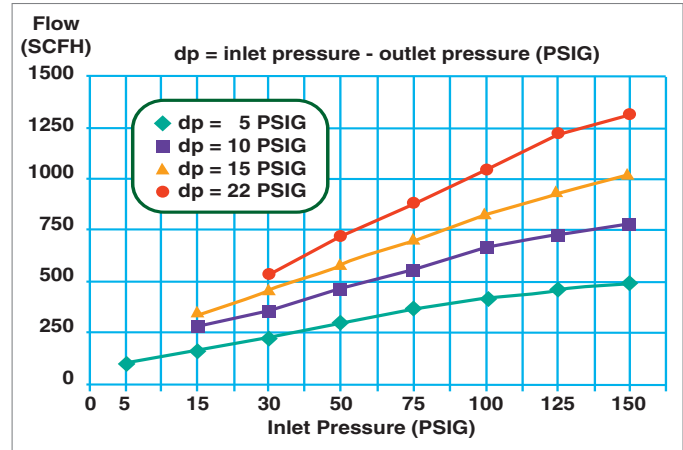

**Ordering Information**

Part No.	Model No.	Gas	Description	Connection
<b>Oxygen – Torch Mount (Torch mount models also protect hose)</b>				
0657-0076	FBHC-O	Oxygen	Torch Mount - High Flow	"B" 9/16"-18 RH (CGA 022)
0657-0077	FBHC-OC	Oxygen	Torch Mount - High Flow	"C" 7/8" - 14 RH (CGA 024)
<b>Oxygen – Regulator Mount</b>				
0657-0078	FBHC-OR	Oxygen	Regulator Mount - High Flow	"B" 9/16" - 18 RH (CGA 022)
0657-0079	FBHC-ORC	Oxygen	Regulator Mount - High Flow	"C" 7/8" - 14 RH (CGA 024)

Flow rates shown in chart are for air. To convert to other gases, multiply the air flow rate by the conversion factor listed.

Nothing can take the place of proper equipment operation. Always read, understand and follow the instructions provided with each product.

**Ordering Information**

Part No.	Model No.	Gas	Description	Connection
<b>Oxygen – Torch Mount</b>				
0657-0010	FB-O	Oxygen	Torch Mount	"B" 9/16"-18 RH (CGA 022)
<b>Oxygen – Regulator Mount</b>				
0657-0014	FB-OR	Oxygen	Regulator Mount	"B" 9/16"-18 RH (CGA 022)
<b>Fuel – Torch Mount</b>				
0657-0011	FB-F	Fuel	Torch Mount	"B" 9/16"-18 LH (CGA 023)
<b>Fuel – Regulator Mount</b>				
0657-0015	FB-FR	Fuel	Regulator Mount	"B" 9/16"-18 LH (CGA 023)
<b>Pair Packs</b>				
0656-0001	FB-1	Oxy/Fuel	Torch Mount	"B" 9/16"-18 RH/LH (CGA 022 & 023)
0656-0004	FBR-1	Oxy/Fuel	Regulator	"B" 9/16"-18 RH/LH (CGA 022 & 023)

Flow rates shown in chart are for air. To convert to other gases, multiply the air flow rate by the conversion factor listed.

Nothing can take the place of proper equipment operation. Always read, understand and follow the instructions provided with each product.

Victor® add-on flashback arrestors contain both a reverse flow check valve and a flashback arrester.

## FlameBuster™ Plus

- Flashback Arrestor with Kwik-Connect™ Coupling
- Designed to prevent flashback from torch to hose (Not for regulators)



### Ordering Information

0656-0002	FBP-1 FlameBuster Plus Torch - Pair Pack
0657-0002	FBP-O FlameBuster Plus Torch
0657-0003	FBP-F FlameBuster Plus Torch

Plug Assemblies available: Oxygen: 0657-0031, Fuel: 0657-0032

## Flashback Arrestor with Kwik-Connect Coupling Components FBP-1

### Ordering Information

0657-0031	Male End Oxygen
0657-0032	Male End Fuel Gas

## Flashback Arrestors Pair Packs



### Ordering Information

Part No.	Model No.	Gas	Description	Connection
0656-0006	FBT-2	Oxy/Fuel	Torch Mount	"B" 9/16"-18 RH/LH (CGA 022 & 023)
0656-0007	FBR-2	Oxy/Fuel	Regulator Mount	"B" 9/16"-18 RH/LH (CGA 022 & 023)

## Reverse Flow Check Valves for Torches & Regulators



### Ordering Information

#### Torch Models

0690-0011	CTO & CTF Torch - Check Valves Pair Pack (Oxygen & Fuel)
0690-0032	CTO Torch - Check Valve (Oxygen)
0690-0033	CTF Torch - Check Valve (Fuel)

#### Regulator Models

0690-0012	CRO & CRF Regulator - Check Valves Pair Pack (Oxygen & Fuel)
0690-0034	CRO Regulator - Check Valve (Oxygen)
0690-0035	CRF Regulator - Check Valve (Fuel)

## Built-in Flash Arrestor

### Retro-Fit Kit

The retro-fit kit allows replacement of built-in flash arrestors for cutting torches without the use of Loctite® or heat

### Ordering Information

#### Torch/Hose Connections

0656-0046	Includes oxygen and fuel cartridges, retainer plate and screws, hex key, and instructions
-----------	---

Repair of oxy/fuel equipment, including flashback arrestor and check valve replacement, should be done by a qualified technician.

## Vanguard™ Flashback Arrestor

### Replacement Cartridge



### Ordering Information

#### Torch/Hose Connections

0657-0036	Torch and Torch Handle Replacement Cartridge (315FC, 100FC, J 100FC) (CST 800FC) (Both Gases)
0657-0068	Torch & Torch Handle Replacement Cartridge (H 315FC, ST 900FC, ST 1000FC, ST 2600FC) (Oxygen)
0657-0069	Torch & Torch Handle Replacement Cartridge (H 315FC, ST 900FC, ST 1000FC, ST 2600) (Fuel Gas)

Flashback arrestor replacement cartridges include an "O" ring but does not include a replacement reverse flow check valve. Part No. 0690-0027 - 9/16" (pair).

## Kwik-Connect

### Torch/Hose Connections



### Ordering Information

#### Torch/Hose Connections

0656-0000	KC-1 Kwik Connect Pair Pack (Oxygen and Fuel)
0312-0090	KCO Kwik Connect (Oxygen)
0312-0091	KCF Kwik Connect (Fuel)

## VCM 200/201

### Portable Cutting Machines

The versatile VCM 200 is a precision, tractor-type machine that can be used on its own track for straight line cutting and a variety of welding operations. Off track and with a radius rod assembly, the VCM 200 can also be used for circle cutting.

- Large thumb screws for hand tight adjustments
- Dual drive controls & direct speed readout
- Cone disc drive
- Constant speed AC induction motor located on the side opposite the torch for cooler, more efficient operation
- Counter-balanced design allows torch racking distance up to 18 in. (457.2 mm) from the machine
- Speed constant over wide range of temperatures
- Torch holder designed for 1.38 in. (35.1 mm) barrel diameter torches
- Flat mounting deck
- HT (high temperature) packages have the addition of a heat shield
- HS (high speed) packages have a speed range of 5 in.-120 in./min (12.7-304.8 cm/min)

Ordering Information	
VCM 200 HS Portable Cutting Machine Package - High Speed	0200-0224
VCM 200 HT Portable Cutting Machine Package - High Temperature	0200-0240
VCM 200 Portable Cutting Machine Package	0200-0220
VCM 201 HS Portable Cutting Machine Package - High Speed	0200-0225F
VCM 201 HT Portable Cutting Machine Package - High Temperature	0200-0241
VCM 201 Portable Cutting Machine Package	0200-0221

#### Package Description #1 VCM 200:

- Cutting machine
- MT 210A torch & torch rack
- Hoses & fittings (for 2 hose operation)
- Hoses & fittings (for 2 hose operation)
- 32 pitch pinion torch holder
- 3 hose manifold block

#### Package Description #2 VCM 201:

- Cutting machine
- Hoses & fittings (for 2 hose operation)
- 32 pitch pinion torch

### VCM 200 Series Ordering Information

Part No.	Model No.	Speed Range/ Minute	See Package Description
0200-0220	VCM 200	1 in.-60 in. (25.4 mm-152.4 cm)	See Package Description #1
0200-0222	VCM 200E**	1 in.-60 in. (25.4 mm-152.4 cm)	See Package Description #1
0200-0224	VCM 200HS	5 in.-120 in. (127 mm-304.8 cm)	See Package Description #1
0200-0226	VCM 200HSE**	5 in.-120 in. (127 mm-304.8 cm)	See Package Description #1
0200-0240	VCM 200HT*	1 in.-60 in. (25.4 mm-152.4 cm)	See Package Description #1
0200-0221	VCM 201	1 in.-60 in. (25.4 mm-152.4 cm)	See Package Description #2
0200-0225	VCM 201HS	5 in.-120 in. (127 mm-304.8 cm)	See Package Description #2
0200-0241	VCM 201HT*	1 in.-60 in. (25.4 mm-152.4 cm)	See Package Description #2

\*Models VCM-200 HT, VCM-201 HT, include heat shield

\*\*Export models available with 220V AC to 110V AC step down transformer



## Specifications

### Straight Line / Circle

- Length increments of 72 in. (182.9 cm) (track length)
- Circle diameters 4 in. (101.6 mm) to 96 in. (243.8 cm)

### Speed Range

- 1-60 in./minute (25.4 mm-152.4 cm/minute)

### Dimensions

- Length - 14.25 in. (362.0 mm)
- Width - 11 in. (279.4 mm) - machine only  
- 28.5 in. (723.9 mm) - machine & torch holder
- Height - 11.5 in. (292.1 mm) - top of torch holder  
- 5.5 in. (139.7 mm) - top of machine

### Weight

- Machine - 47 lbs (21 kg)

## VCM 200 HS

### HIGH SPEED

- Has all the convenience and portability features of the standard VCM-200 machine, plus a speed range of 5-120"/min (12.7-304.8 cm/min). The VCM-200HS has a flat mounting deck.

## VCM 200 HT

### HIGH TEMPERATURE

- Same convenience, portability features and speed of the VCM-200 (Max. temp. 300°F), plus the addition of a heat shield.

## Torch Holder Adapter

### Part No. 0252-0138

- The Torch Holder Adaptor is used to adapt the Victor® Thermal Dynamics® SL100 180° Degree plasma torches to the VCM machine. The torch adaptor allows the machine torch to mount on 1 3/8" mounting tube.

Please contact Technical Services on 1-800-426-1888 for more information.

Accessory Ordering Information	
12 ft (3.7 m) Track Section for Line Cutting	0212-0018
9 ft (2.7 m) Track Section for Line Cutting	0212-0019
6 ft (1.8 m) Track Section for Line Cutting	0212-0005
Radius Rod for Circle Cutting	0252-0040
100 in. (254.0 cm) Radius Rod for Circle Cutting	0252-0042
Dual Torch Mount Assembly	0252-0136
Heat Shield	0252-0103

## Welding Accessory Tools



### Replacement Hoses

Part No.	Description	Fitting	Fuel Gas Type
1412-0012	3/16 in. x 12.5 ft. Dual R-Grade	"A" 3/8"-24	Acetylene
1412-0020	3/16 in. x 25 ft. Dual R-Grade	"A" 3/8"-24	Acetylene
1412-0021	1/4 in. x 25 ft. Dual R-Grade	"B" 9/16"-18	Acetylene
1412-0022	1/4 in. x 50 ft. Dual R-Grade	"B" 9/16"-18	Acetylene
1412-0134	3/16 in. x 12.5 ft. Dual T-Grade	"A" 3/8"-24	All
1412-0128	1/4 in. x 25 ft. Dual T-Grade	"B" 9/16"-18	All

## L1- Single Flint Striker



### Ordering Information

1423-0061 | L1 Single Flint Striker

## Triple Flint Striker



### Ordering Information

0386-0297 | Triple Flint Striker

## Flint Refills



- F-1 Flint Refills
- For L- Single Flint Striker



- For Triple Flint Striker

### Ordering Information

1423-0024 | F-1 Flint Refills for L-Single Flint Striker  
0386-0298 | Flint Refills for Triple Flint Striker

## TK Tank Key



- Fits B & MC Tanks

### Ordering Information

0386-1226 | TK Tank Key

## Tip Cleaner



### Ordering Information

0386-1213 | Tip Cleaner

# // ARC GOUGING & EXOTHERMIC CUTTING



# ARCAIR®

AN ESAB® BRAND



# ARCAIR® AIRPRO X4000: CARBON ARC GOUGING TORCH AND CABLE.

Arcair – the name synonymous with carbon arc gouging – introduces the AirPro X4000, a torch that takes ease of use to a new level.

Instead of using 27 lbs. of grip pressure to open the torch, the operator merely pushes a rocker switch. Compressed air already flowing through the AirPro X4000 torch pneumatically opens the torch jaws so operators can insert, adjust and remove carbons without effort.

- Pneumatic upper arm lifts when activated by the rocker switch on the torch handle.
- Rocker switch allows insertion/adjustment of carbon and controls compressed air on/off. Latch mechanism locks “On” airflow when in use.
- No air flows through the torch or the cable without initiating the flow through the rocker switch.
- No-leak air valve saves electricity and maintenance costs of maintaining the shop air compressor.
- Elimination of the lever assembly creates a lower-profile torch for improved access.

## ARCAIR CARBONS.

The AirPro X4000 accepts 3/16- to 1/2-in. (4.7 mm -12.7 mm) pointed round, 3/8- and 5/8-in. (9.5 mm-15.8 mm) flat and 5/8-in. (15.8 mm) half-round carbons.

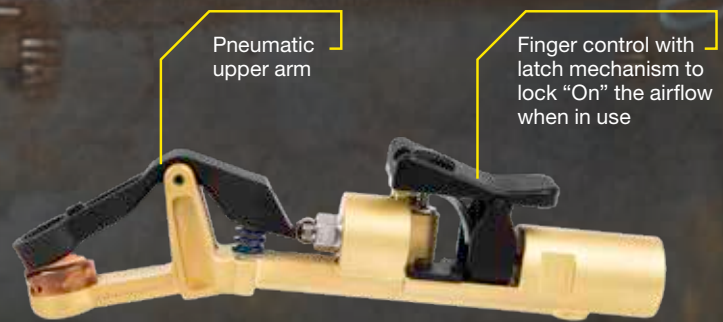



# CONTENTS

## MANUAL GOUGING

- Gouging Torches ..... 179
- Improved Carbon-Arc Torch Cable Boot Design ..... 179
- Gouging Techniques for Specific Materials..... 180
- Angle-Arc® Manual Gouging Torches..... 181
- K3000™..... 182
- Swivel Cable Assembly Options ..... 182
- K4000® ..... 182
- AirPro™ X4000 - Pneumatic Gouging Torch & Cable Assembly ..... 183
- AirPro™ X4000 ..... 184
- Swivel Cable Assembly ..... 184
- Tri-Arc® Foundry Gouging Torches..... 185
- Tri-Arc Torch Heads..... 185
- Tri-Arc® ..... 186
- Swivel Cable Assembly Options ..... 186
- Straight Handle Manual Gouging Torches..... 187
- K-5..... 187
- CutSkill Manual Gouging Torches ..... 187
- CSK4000 ..... 187
- Inches of Groove per Electrode..... 188
- Arcair Air Carbon-Arc Electrodes ..... 189
- CutSkill Electrodes ..... 190
- Welding Carbon Products ..... 190

## AUTOMATED GOUGING

- Arcair-Matic® N7500..... 191
- All Position Travel Systems ..... 192
- Bug-O Travel System Packages..... 192
- GULLCO Travel System Packages..... 192

## EXOTHERMIC CUTTING

- SLICE® Exothermic Cutting System..... 193
- Tips for Using SLICE® Exothermic Cutting Equipment ..... 194
- SLICE® Battery/Utility Pack..... 195
- SLICE® Battery Ignition Source ..... 195
- SLICE® Industrial Pack..... 196
- SLICE® Complete Pack ..... 196
- SLICE® Striker Assembly..... 197
- SLICE® Cutting Rods..... 197

## UNDERWATER CUTTING & WELDING

- Sea Torch® “Combination Torch” ..... 199
- Underwater Cutting Electrodes ..... 199
- Sea-Stinger® II Torch ..... 200
- Underwater Welding Electrodes..... 200

## PROTEX® CHEMICALS

- Protex Original Anti-Spatter ..... 202
- Protex Extra Anti-Spatter ..... 202
- Protex Plus Anti-Spatter..... 203
- Protex Tip Dip Anti-Spatter ..... 203
- Protex Alclean Anti-Spatter ..... 203

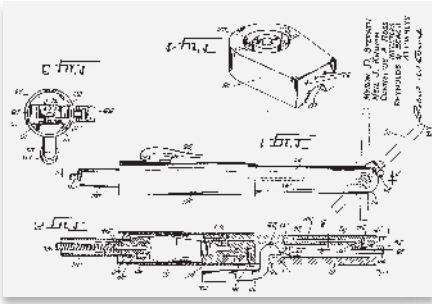

**1949**

- Myron Stepath invents CAC-A cutting and gouging process.
- Stepath founds Arcair Co.
- Introduces G-3 cutting and gouging torch.



**1956**

Introduces H-5 cutting and gouging torch.



**1961**

Arcair relocates manufacturing to Lancaster, Ohio.



**1968**

Introduces K-3 cutting and gouging torch.



**1972**

Introduces Underwater Cutting and Welding Torch.



**1974**

Myron Stepath retires.

**1980s**

SLICE® torch introduced, allowing for portable, quick cutting solutions for fire and rescue operations.

# ARCAIR IS SYNONYMOUS WITH **CARBON ARC GOUGING**



**1983**  
Introduces K4000<sup>®</sup>  
cutting and gouging torch.

**1989**  
Arcair relocates to Wichita,  
Kansas; combines  
manufacturing with Tweco.



**2004**  
Arcair relocates to  
Denton, Texas combines  
manufacturing with Victor.

**2011**  
Introduces Arcair-Matic<sup>®</sup>  
N7500 Automated  
gouging System.



**2014**  
Arcair becomes  
An ESAB Brand



**2018**  
Introduces AirPro X4000  
gouging torch and  
cable assembly with  
the industry's first ever  
pneumatic arm.

## Gouging Torches

### Improved Torch Air Flow

- More efficient use of air supply
- Improved metal removal

### Four Hole Head Assembly

- Optimizes air flow to the arc
- Efficiently cleans slag from groove edge

### Air Assist Positive Air Shut-Off

- Minimizes air supply unit cycling on and off
- Allows torch usage when air supply is marginal

### Improved Cable Electrical Conduction

- Improves cable service life
- Decreases heat build up in cable and torch

### Superior Outer Cable Cover

- Durable cover for improved cable life in a harsh environment
- Resists breakdown due to exposure to heat produced by gouging

### Insulated Connection Boot & Hook-Up Kit

- Makes for easy torch hook-up
- Virtually eliminates the possibility of arcing when contacting electrically hot parts

## Improved Carbon-Arc Torch Cable Boot Design

### Patented Two-Piece Boot Design

- Molded from a hard nylon reinforced fiber polymer made to withstand the substantial abuse in shop and field applications

### Helps Prevent Accidental Arcing

- No chance of the “boot” pulling away from the power connection as seen with prior “boot” design

### Ease of Replacement in the Field

- Threaded screws holds the two halves together and can be loosened with a standard straight blade screwdriver

### Available in Two (2) Different Molded “Boot” Housing Configurations

- Conventional Boot (Part No. 94-105-032)
  - Accepts one 4/0 welding cable from the power supply and one 3/4 in. (19 mm) diameter air hose assembly providing current and compressed air
- Quick-Connect Hook-Up Kit (Part No. 94-463-046)
  - Twist lock-style power connection and air hose extending from the rear of the torch cable
- This option allows the operator to connect or disconnect the incoming power lead and air line quickly and easily



Angle-Arc®  
Gouging Torches



Straight Handle  
Gouging Torches



Tri-Arc®  
Gouging Torches



Conventional  
Replacement Part No. 94-105-032



Quick-Connect Hook-Up Kit  
Replacement Part No. 94-463-046

**NOTE:** Replacement Boots will fit onto all Arcair manual hand torch cable assemblies having an amperage range of 1000 Amps or less.



**THE “BEST” JUST GOT BETTER.**

Help prevent accidental arcing in your workplace.

## Googing Techniques for Specific Materials

### Carbon Steel & Low Alloy Steel (such as ASTM A514 & A517) & Stainless Steel

- Use DC electrodes with DCEP (electrode positive). AC electrodes with an AC transformer can be used, but for this application, AC is only half as efficient as DC.

### Cast Iron Including Malleable & Ductile Iron (nodular)

- Use 1/2 in. (12.7 mm) or larger diameter CCDC electrodes at the highest rated amperage. Use an angle of 70° off the workpiece and the depth of gouge should not exceed 1/2 in. (12.7 mm) per pass

### Copper Alloys (copper content 60% and under)

- Use CCDC electrodes with DCEN (electrode negative) at the electrode's highest amperage rating

### Aluminum Bronze & Aluminum Nickel Bronze (naval propeller alloy)

- Use CCDC electrodes with DCEN (electrode negative) at the electrode's highest amperage rating

### Nickel Alloys (nickel content over 80% of mass)

- Use CCAC electrodes with AC current

### Nickel Alloys (nickel content under 80% of mass)

- Use CCDC electrodes with DCEP (electrode positive) at the electrode's highest amperage rating

### PRINCIPLES OF AIR CARBON ARC

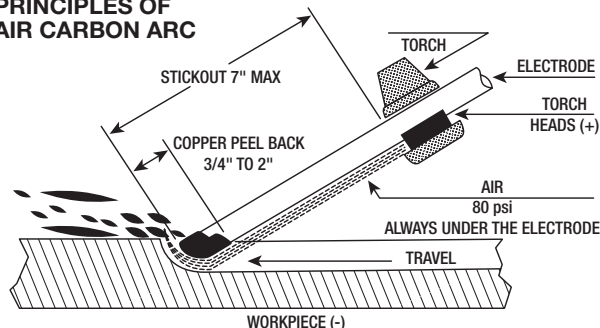

### Magnesium Alloys

- Use CCDC electrodes with DCEP (electrode positive) and prior to welding, wire brush the groove

### Aluminum

- Use CCDC electrodes with DCEP (electrode positive).
- You must brush with a stainless wire brush before welding. Electrode stick-out (length of electrode between torch and workpiece) should not exceed 3 in. (76.2 mm)

### Titanium, Zirconium, Hafnium, & Their Alloys

- Do not cut or gouge to prepare for welding or remelting unless you mechanically remove the surface layer from the cut/gouge surface *NOTE – If you preheat for welding, preheat for gouging.*

Current Requirements												
Electrode	1/8 in. (3.2 mm)	5/32 in. (4.0 mm)	3/16 in. (4.8 mm)	1/4 in. (6.4 mm)	5/16 in. (7.9 mm)	3/8 in. (9.5 mm)	1/2 in. (13 mm)	5/8 in. (16 mm)	3/4 in. (19 mm)	1 in. (25 mm)	3/8 in. (9.5 mm) Flat	5/8 in. (16 mm) Flat
Minimum amps DC	60	90	200	300	350	450	800	1000	1250	1600	250	300
Maximum amps DC	90	150	250	400	450	600	1000	1250	1600	2200	450	500
Minimum amps AC	–	–	200	300	–	350	–	–	–	–	–	–
Maximum amps AC	–	–	250	400	–	450	–	–	–	–	–	–

Gouging Torch Selection Guide							
Copperclad Electrodes	Amperage Range					Recommended	Alternate
	90 – 450	450 - 1000	1000 -1400	1400 – 2000	2000 - 2400		
1/8 in. - 3/8 in. Round (3.2 mm - 9.5 mm) 3/8 in. & 5/8 in. Flats (9.5 mm & 15.9 mm)	██████████					K3000	–
5/32 in. – 1/2 in. Round (4.0 mm – 12.7 mm) 3/8 in. & 5/8 in. Flats (9.5 mm & 15.9 mm)	██████████					AirPro X4000	K4000
5/16 in. - 5/8 in. Round (7.9 mm - 15.9 mm)	██████████					K-5	Tri-Arc, AirPro X4000, K4000
5/16 in. – 1 in. Round (7.9 mm – 25.4 mm)	██████████					Tri-Arc	–

Which Torch Is Right For You?								
Torch Model	Amperage (Maximum)	Swivel Cable	Swivel Cable Lengths	Air-Cooled Water-Cooled	Handle Design	Body/Upper Arm Construction	Application	Special Features
K3000	600	360°	7 ft & 10 ft (2 m & 3 m)	Air-Cooled	Small & Ergonomic	Brass	Medium Duty	All brass torch parts with a copper head assembly having 4-hole design
K4000	1000	360°	7 ft & 10 ft (2 m & 3 m)	Air-Cooled	Small & Ergonomic	Brass	Heavy Duty	All brass torch parts with a copper head assembly having 4-hole design
AirPro X4000	1000	360°	7 ft & 10 ft (2 m & 3 m)	Air-Cooled	Small & Ergonomic	Brass	Heavy Duty	All brass torch parts with a copper head assembly having 4-hole design, pneumatically operated upper arm
K-5	1250	340°	7 ft & 10 ft (2 m & 3 m)	Air-Cooled	Straight	Brass	Heavy Duty	All brass torch parts with a copper head assembly having 4-hole design
Tri-Arc	2200	340°	7 ft & 10 ft (2 m & 3 m)	Air-Cooled & Water-Cooled	Straight	Copper	Heavy Duty	Versatility with three (3) different head assemblies to choose from to meet any metal removal application

## Angle-Arc® Manual Gouging Torches

MANUAL GOUGING

### Natural 15° Torch Angle

- Greater operator comfort

### Durable Front Insulators

- High impact and heat resistant protecting the torch metal parts

### 360° Swivel Cable

- Less cable twist
- Less strain on operator

### Positive Grip Handle

- Greater operator feel and ease in positioning the torch

### Reduced Weight

- Optimum cable and torch weight to minimize fatigue

### High Quality Cable Hose

- Best quality cable hose offers high heat and abrasion resistance
- Non-conductive

K3000

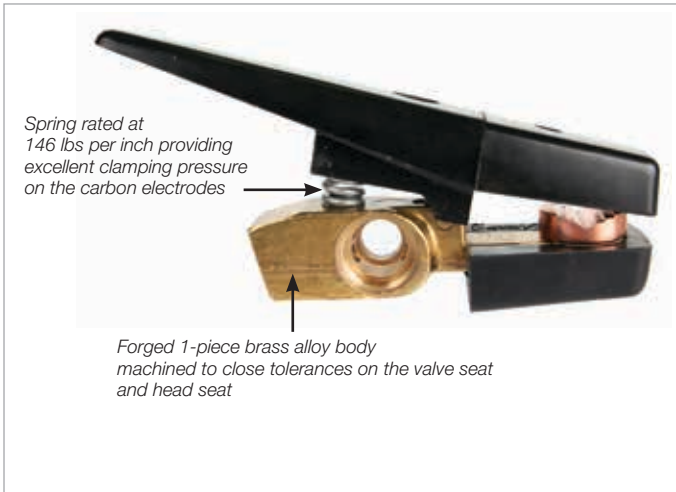

K4000

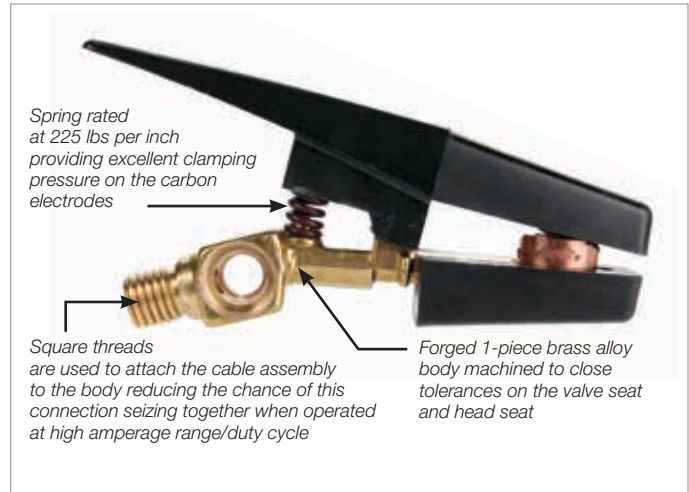

**Heavy-duty insulators**, lever and handle that are all made from fiberglass reinforced thermoset polyester molding compound to withstand the heat and be impact resistant



## K3000™

Medium Duty - General repair and maintenance jobs such as mining, construction, and all types of metal fabrication.



### Amperage Range

- 90 – 600 amps

### Electrode Size

- Pointed – 1/8 in. – 3/8 in. round (3.2 mm – 9.5 mm)
- Jointed – 5/16 in. – 3/8 in. round (7.9 mm – 9.5 mm)
- Flat – 3/8 in. and 5/8 in. (9.5 mm – 15.9 mm)
- Half Round – 5/8 in. (15.9 mm)

### Air Requirements

- psi – 80
- kg/cm<sup>2</sup> – 5.6
- cfm – 22
- l/min – 624

Ordering Information	
01065001	Torch Only
61065006	Torch w/7 ft (2.1 m) 360° Swivel Cable
61065002	Torch w/7 ft (2.1 m) 360° Swivel Cable & Insulated Hook-Up Kit
61065007	Torch w/10 ft (3 m) 360° Swivel Cable
61065003	Torch w/10 ft (3 m) 360° Swivel Cable & Insulated Hook-Up Kit

## K4000®

Heavy Duty - Heavy metal removal applications such as weld preparations in pressure vessel shops and shipyards.



### Amperage Range

- 90 – 1000 amps

### Electrode Size

- Pointed – 5/32 in. – 1/2 in. round (4.0 mm – 12.7 mm)
- Jointed – 5/16 in. – 1/2 in. round (7.9 mm – 12.7 mm)
- Flat – 3/8 in. and 5/8 in. (9.5 mm – 15.9 mm)
- Half Round – 5/8 in. (15.9 mm)

### Air Requirements

- psi – 80
- kg/cm<sup>2</sup> – 5.6
- cfm – 25
- l/min – 708

Ordering Information	
01082002	Torch Only
61082008	Torch w/7 ft (2.1 m) 360° Swivel Cable
61082006	Torch w/7 ft (2.1 m) 360° Swivel Cable & Insulated Hook-Up Kit
61082009	Torch w/10 ft (3 m) 360° Swivel Cable
61082007	Torch w/10 ft (3 m) 360° Swivel Cable & Insulated Hook-Up Kit

## Swivel Cable Assembly Options

K3000 360° Swivel Cable



K4000 360° Swivel Cable



Ordering Information		
K3000	K4000	
70088107	70084207	7 ft (2.1 m) 360° Swivel Cable Assembly
70088110	70084210	10 ft (3 m) 360° Swivel Cable Assembly

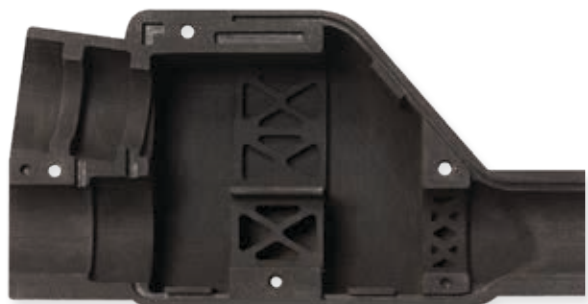
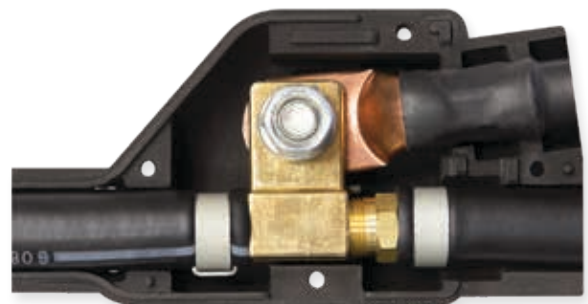

## AirPro™ X4000 – Pneumatic Gouging Torch & Cable Assembly

MANUAL  
GOUGING

### Easy to Load

- Uses compressed air to raise and lower the upper arm; no force required to load/unload electrodes

### Simple Operation

- To gouge, press the rocker switch and slide lock forward to lock in place to begin the airflow through the torch assembly; simply slide the lock back and release the rocker switch to stop

### No Leaks

- Positive air valve to eliminate compressed air from leaking

### Positive Grip Handle

- Greater operator feel and ease in positioning the torch

### Durable Front Insulators

- High impact and heat resistance protecting the torch metal parts



**Pneumatically operated upper arm**  
for ease of inserting/adjusting the carbon  
electrode in the torch head assembly

**Rocker switch** allowing the insertion/adjustment  
of the carbon electrode and compressed air  
on/off; no air flow through the torch and cable  
assembly without initiating flow through the  
rocker switch

PATENTED  
US Patent 11,440,123.

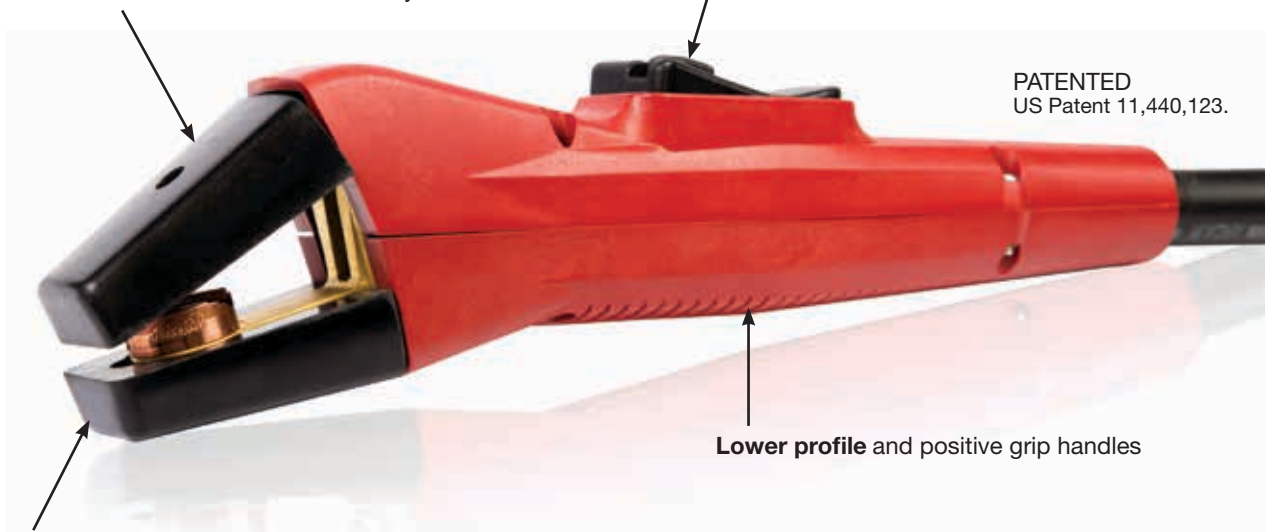

**Lower profile and positive grip handles**

**High impact, heat resistant insulators**



## AirPro™ X4000

Introducing the next generation air carbon-arc metal removal torch and cable assembly, AirPro X4000. The unique, patented\*, pneumatically operated upper arm and air valve design eliminates air leakage through the torch and cable when turned off, making this torch assembly the best in the market.



Ideal for the following industries:

- Ship and Offshore Yards
- Civil Construction
- Pipe Construction
- Repair and Maintenance
- Heavy Fabrication
- Industrial and General Fabrication
- Mining
- Steel Erectors

### Amperage Range

- 90 – 1000 amps

### Electrode Size

- Pointed – 3/16 in. – 1/2 in. round (4.7 mm – 12.7 mm)
- Jointed – 5/16 in. – 1/2 in. round (7.9 mm – 12.7 mm)
- Flat – 3/8 in. and 5/8 in. (9.5 mm – 15.9 mm)
- Half Round – 5/8 in. (15.9 mm)

### Air Requirements

- psi – 80
- kg/cm2 – 5.6
- cfm – 25
- l/min – 708

### Ordering Information

61084008	AirPro X4000 Torch & Cable Assembly 7 ft. (2.1 m) – 360° Swivel
61084006	AirPro X4000 Torch & Cable Assembly 7 ft. (2.1 m) – 360° Swivel & Insulated Hook-up Kit
61084007	AirPro X4000 Torch & Cable Assembly 10 ft. (3 m) – 360° Swivel & Insulated Hook-up Kit

## Swivel Cable Assembly



### Ordering Information

70084407	7 ft (2.1 m) 360° Swivel Cable
70084410	10 ft (3 m) 360° Swivel Cable
94463046	Quick Connect Hook-Up Kit

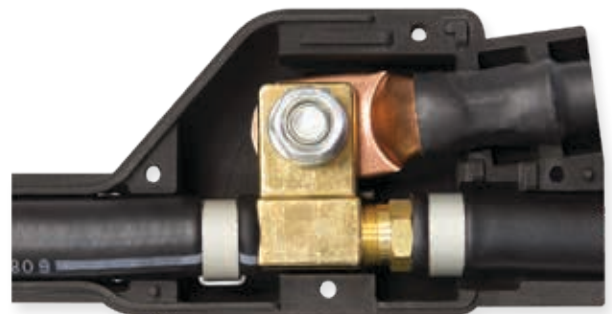

\* Patented - US Patent 11,440,123.

## Tri-Arc® Foundry Gouging Torches

### Three Torches in One

- Designed for foundry applications, defect removal, general purpose applications, and padwashing by just changing head assemblies

### High Impact, Heat Resistant Insulators

- Provides protection for the torch metal parts

### Forged Body

- Provides cooler operation, improved air flow and greater current ratings

### Powerful Insulated Coil Spring & High Strength Upper Arm

- Insures positive electrode contact at all angles

### Better Balance

- Streamline design and high strength fluted handles reduce operator fatigue

### Easy Cable Installation

- No need to disassemble the torch, just slide the sleeve from the rear of the handle

## Tri-Arc Torch Heads

### Defect Removal Heads

- For removal of defects and fine removal application
- Accepts electrode diameters – 3/8 in. (9.5 mm) through 3/4 in. (19.05 mm)



### General Purpose Cleaning Heads

- For removal of defects, fin removal, padwashing, and piercing applications
- Accepts electrode diameters – 1/2 in. (12.7 mm) through 1 in. (25.4 mm)



### Padwashing Heads

- For padwashing applications only
- Heads are fixed on a 35° work angle
- Accepts electrode diameters – 1/2 in. (12.7 mm) through 3/4 in. (19.05 mm)



**Heavy-duty insulators**, lever and handle that are all made from fiberglass reinforced thermoset polyester molding compound to withstand the heat and be impact resistant

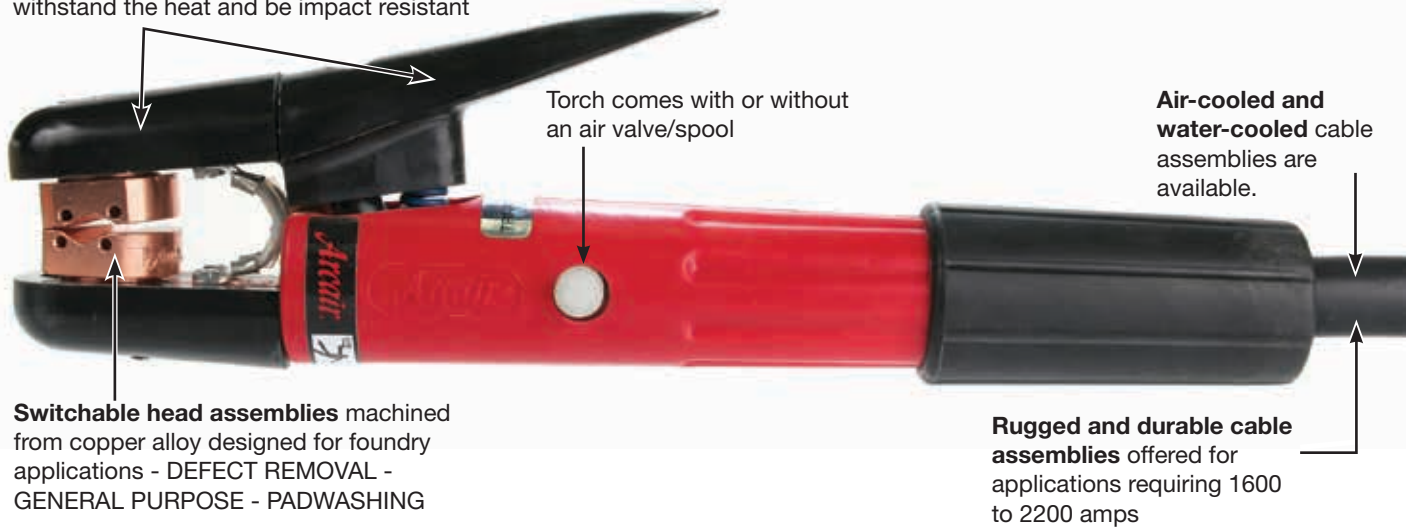

**Switchable head assemblies** machined from copper alloy designed for foundry applications - DEFECT REMOVAL - GENERAL PURPOSE - PADWASHING

**Rugged and durable cable assemblies** offered for applications requiring 1600 to 2200 amps

**Compressed air** flows through the body and upper arm increasing the metal removal capabilities on this torch

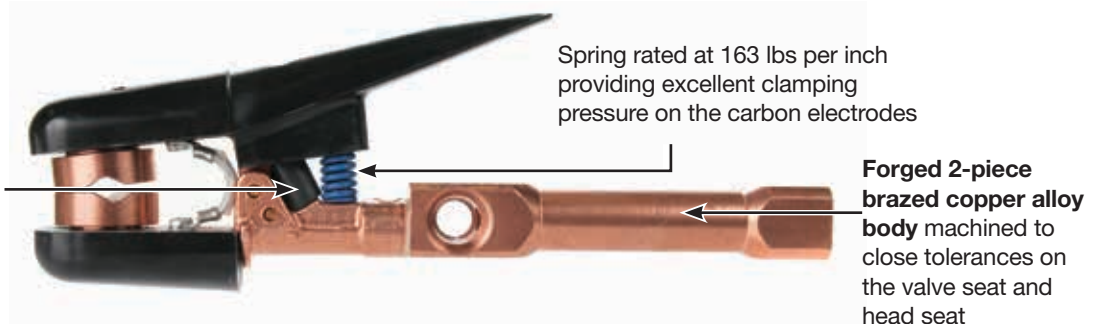

Spring rated at 163 lbs per inch providing excellent clamping pressure on the carbon electrodes

**Forged 2-piece brazed copper alloy body** machined to close tolerances on the valve seat and head seat

## Tri-Arc®

Foundry - General foundry work, pad washing, defect, nails, sprue and interior work



### Amperage Range

- 450 – 2200 amps

### Electrode Size

- 5/16 in. – 1 in. Round (7.9 mm – 25.4 mm)

### Air Requirements

- psi – 80
- kg/cm<sup>2</sup> – 5.6
- cfm – 33
- l/min – 934

Ordering Information		
No Heads in Torch		Electrode Size
02991411	Torch Only	–
62991417	Torch & 7 ft (2.1 m) Cable	–
No Heads in Torch – No Valve		Electrode Size
02991426	Torch Only	–
Defect Removal Heads		Electrode Size
94378298	Replacement Heads	3/8 in. (9.5 mm) thru 3/4 in. (19.05 mm)
Padwashing Heads		Electrode Size
94378286	Replacement Heads	1/2 in. (12.7 mm)
94378289	Replacement Heads	5/8 in. (15.9 mm)
94378283	Replacement Heads	3/4 in. (19.05 mm)
General Purpose Cleaning Heads		Electrode Size
94378267	Replacement Heads	1/2 in. (12.7 mm)
94378270	Replacement Heads	5/8 in. (15.9 mm)
94378273	Replacement Heads	3/4 in. (19.05 mm)
94378343	Replacement Heads	1 in. (25.4 mm)

Note: The cable assembly that comes standard on the assemblies is Part No. 74143607, 7 ft (2.1 m) long and rated for 1600 amperes maximum.

## Swivel Cable Assembly Options



MANUAL  
GOUGING

Ordering Information		
7 ft (2.1 m)	10 ft (3 m)	
74143607	74143610	Std. Duty - 340° Swivel Cable Assembly
74161907	–	E-H-D 340° Swivel Cable Assembly
74085207	74085210	Water-Cooled Cable Assembly – Non-Swivel



K-5 Swivel Cable

Ordering Information	
70128507	7 ft (2.1 m) 340° Swivel Cable Assembly
70128510	10 ft (3 m) 340° Swivel Cable Assembly

## Straight Handle Manual Gouging Torches

### Reliable Torch Design

- Market leader for over 60+ years
- Greater operator comfort

### Accepts a Wide Range of CCDC Gouging Electrodes

- 5/16 in. (7.9 mm) - through 5/8 in. (15.9 mm) round

### Durable Front Insulators

- High impact and heat resistant protecting the torch metal parts

### Swivel Cable

- Less cable twist
- Less strain on the operator

### High Quality Cable Hose

- Best quality cable hose offers high heat and abrasion resistance
- Non-conductive

### Rugged Construction Overall

- Can withstand harsh environments

## K-5

Extra Heavy-Duty - Heavy metal removal applications such as weld preparations in pressure vessel shops, shipyards and defect removal in foundries.



### Amperage Range

- 450 – 1250 amps

### Electrode Size

- Pointed – 5/16 in. – 1/2 in. round (7.9 mm – 12.7 mm)
- Jointed – 5/16 in. – 5/8 in. round (7.9 mm – 15.9 mm)
- Half Round – 5/8 in. (15.9 mm)

### Air Requirements

- psi – 80
- kg/cm<sup>2</sup> – 5.6
- cfm – 30
- l/min – 850

### Ordering Information

01104003	Torch Only
61104007	Torch w/7 ft (2.1 m) 360° Swivel Cable
61104008	Torch w/10 ft (3 m) 360° Swivel Cable

## CutSkill Manual Gouging Torches

### Natural 15° Torch Angle

- Greater operator comfort

### Durable Front Insulators

- High impact and heat resistant protecting the torch metal parts

### 360° Swivel Cable

- Less cable twist
- Less strain on operator

### Positive Grip Handle

- Greater operator feel and ease in positioning the torch

### Reduced Weight

- Optimum cable and torch weight to minimize fatigue

### High Quality Cable Hose

- Best quality cable hose offers high heat and abrasion resistance
- Non conductive

## CSK4000

Heavy-Duty - Heavy metal removal applications such as weld preparations in pressure vessel shops and shipyards.



### Electrode Size

- Pointed – 5/32 in. – 1/2 in. round (4.0 mm – 12.7 mm)
- Jointed - 5/16 in. – 1/2 in. round (7.9 mm – 12.7 mm)
- Flat – 3/8 in. and 5/8 in. (9.5 mm – 15.9 mm)
- Half Round – 5/8 in. (15.9 mm)

### Air Requirements

- Maximum Amperage – 1000 amps
- Compressed Air – 80 psi (5.6 kg/cm<sup>2</sup>)
- Compressed Air Flow Rate – 28 cfm (0.79 m<sup>3</sup>/min)
- Torch and Cable Weight: 5.4 lbs (2.4 kg)

### Ordering Information

01088000	Torch Only
61088007	Torch & 7 ft (2.1 m) Cable Assembly
61088010	Torch & 10 ft (3 m) Cable Assembly
70088007	7 ft (2.1 m) Cable Assembly
70088010	10 ft (3 m) Cable Assembly

## Inches of Groove per Electrode

Pointed Copperclad DC Electrodes						
Groove Depth	5/32 in. x 12 in. (4.0 mm x 30.5 cm)	3/16 in. x 12 in. (4.8 mm x 30.5 cm)	1/4 in. x 12 in. (6.5 mm x 30.5 cm)	5/16 in. x 12 in. (8.0 mm x 30.5 cm)	3/8 in. x 12 in. (9.5 mm x 30.5 cm)	1/2 in. x 14 in. (12.7 mm x 35.6 cm)
1/8 in. (3.2 mm)	65 in. (165 cm)	70 in. (178 cm)	81 in. (206 cm)	NR	NR	NR
5/32 in. (4.0 mm)	57 in. (145 cm)	65 in. (165 cm)	70 in. (178 cm)	81 in. (206 cm)	NR	NR
3/16 in. (4.8 mm)	NR	57 in. (145 cm)	66 in. (168 cm)	72 in. (183 cm)	82 in. (208 cm)	NR
1/4 in. (6.4 mm)	NR	46 in. (117 cm)	58 in. (147 cm)	66 in. (168 cm)	72 in. (183 cm)	112 in. (285 cm)
5/16 in. (8.0 mm)	NR	20 in. (51 cm) – 2P	46 in. (117 cm)	58 in. (147 cm)	59 in. (150 cm)	100 in. (254 cm)
3/8 in. (9.5 mm)	NR	12 in. (30 cm) – 2P	24 in. (61 cm) – 2P	47 in. (119 cm)	59 in. (150 cm)	88 in. (224 cm)
1/2 in. (12.7 mm)	NR	NR	14 in. (36 cm) – 2P	26 in. (66 cm) – 2P	47 in. (119 cm)	73 in. (185 cm)
5/8 in. (15.9 mm)	NR	NR	NR	16 in. (41 cm) – 2P	26 in. (66 cm) – 2P	57 in. (145 cm)
3/4 in. (19.05 mm)	NR	NR	NR	NR	16 in. (41 cm) – 2P	43 in. (109 cm)
7/8 in. (22.0 mm)	NR	NR	NR	NR	NR	35 in. (89 cm) – 2P
1 in. (25.4 mm)	NR	NR	NR	NR	NR	28 in. (71 cm) – 2P

Note: All figures derived from gouging mild steel under laboratory conditions. Field results may vary due to type of metal, power source, compressed air supply, operators experience and other parameters.

NR = Not Recommended

2P = Two (2) Passes

Jointed Copperclad DC Electrodes			
Groove Depth	5/16 in. x 14 in. (7.9 mm x 35.6 cm)	3/8 in. x 17 in. (9.5 mm x 43.2 cm)	1/2 in. x 17 in. (12.7 mm x 43.2 cm)
5/32 in. (4.0 mm)	160 in. (406 cm)	NR	NR
3/16 in. (4.8 mm)	142 in. (361 cm)	206 in. (523 cm)	NR
1/4 in. (6.4 mm)	125 in. (318 cm)	172 in. (437 cm)	260 in. (660 cm)
5/16 in. (7.9 mm)	112 in. (284 cm)	150 in. (310 cm)	188 in. (478 cm)
3/8 in. (9.5 mm)	84 in. (213 cm)	136 in. (345 cm)	157 in. (399 cm)
1/2 in. (12.7 mm)	72 in. (183 cm) – 2P	103 in. (262 cm)	140 in. (356 cm)
5/8 in. (15.9 mm)	48 in. (122 cm) – 2P	75 in. (191 cm) – 2P	102 in. (259 cm)
3/4 in. (19.05 mm)	NR	57 in. (145 cm) – 2P	90 in. (229 cm)
7/8 in. (22.0 mm)	NR	NR	80 in. (203 cm)
1 in. (25.4 mm)	NR	NR	72 in. (183 cm)

Note: All figures derived from gouging mild steel under laboratory conditions. Field results may vary due to type of metal, power source, compressed air supply, operators experience and other parameters.

NR = Not Recommended

2P = Two (2) Passes

## Arcair Air Carbon-Arc Electrodes

### Designed Specifically for the Air Carbon-Arc Process

- Contain a precise formulated blend of carbon and graphite
- The most efficient metal removal performance in today's market
- Superior metal removal rates, cool operation, and uniform diameters

### Ideal for a Broad Range of Applications

- Creating u-grooves for weld joint
- Removing old welds
- Gouging out cracks
- Cleaning and repairing castings
- Removing hard surface material
- Rough machining

#### Pointed Copperclad DC Electrodes

Part No.	Description	Application
22023003	1/8 in. (3.2 mm) x 12 in. (30.5 cm) CCDC Pointed*	A standard, all-purpose gouging electrode. Its controlled copper coating improves electrical conductivity (for more efficient, cooler operation) and helps maintain electrode diameter at the point of the arc.
22983003	5/32 in. (4.0 mm) x 12 in. (30.5 cm) CCDC Pointed	
22033003	3/16 in. (4.8 mm) x 12 in. (30.5 cm) CCDC Pointed	
22043003	1/4 in. (6.4 mm) x 12 in. (30.5 cm) CCDC Pointed	
22053003	5/16 in. (7.9 mm) x 12 in. (30.5 cm) CCDC Pointed	
22063003	3/8 in. (9.5 mm) x 12 in. (30.5 cm) CCDC Pointed	
22082003	1/2 in. (12.7 mm) x 14 in. (35.6 cm) CCDC Pointed	

Note: Standard 50 pieces per carton unless noted. \* 100 pieces per carton.

#### Pointed Plain DC Electrodes

Part No.	Description	Application
21983003	5/32 in. (4.0 mm) x 12 in. (30.5 cm) DC Pointed	General purpose electrodes without the copper plating to avoid any chance of copper contamination in the base material. Same high quality blend of carbon and graphite used in other electrodes.
21043003	1/4 in. (6.4 mm) x 12 in. (30.5 cm) DC Pointed	
21053003	5/16 in. (7.9 mm) x 12 in. (30.5 cm) DC Pointed	
21063003	3/8 in. (9.5 mm) x 12 in. (30.5 cm) DC Pointed	

Note: Electrodes will glow incandescent due to not having the copper plating and a penciling affect will take place along the outside diameter of the electrode. Standard 50 pieces per carton unless noted.

#### Pointed Copperclad AC Electrodes

Part No.	Description	Application
20033003	3/16 in. (4.8 mm) x 12 in. (30.5 cm) CCAC Pointed	Designed for use with A.C. power supplies. Rare earth material is added to the electrodes to stabilize the arc and enhance the operating characteristics. 12 in. (305 mm) long.
20043003	1/4 in. (6.4 mm) x 12 in. (30.5 cm) CCAC Pointed	
20063003	3/8 in. (9.5 mm) x 12 in. (30.5 cm) CCAC Pointed	

#### Flat Copperclad DC Electrodes

Part No.	Description	Application
35099003	3/8 in. (9.5 mm) x 3/16 in. (4.8 mm) x 12 in. (30.5 cm) Flat	Specially designed for close tolerance metal removal and scarfing applications. Excellent for general gouging applications, removing weld crowns, repairing or making dies, removing temporary welded dogs, and scarfing billets.
35033003	5/8 in. (15.9 mm) x 3/16 in. (4.8 mm) x 12 in. (30.5 cm) CCDC Flat	

Note: Standard 50 pieces per carton unless noted.

#### Half Round Copperclad DC Electrodes

Part No.	Description	Application
25103003	5/8 in. (15.9) x 5/16 in. (7.9 mm) x 12 in. (30.5 cm) CCDC Half-Round	Versatility of having both a round and flat electrode for the various gouging applications. Excellent for removing weld crowns, repairing or making dies, removing temporary welded dogs, and scarfing billets.

Note: Standard 50 pieces per carton unless noted.

#### Jointed Jetrods® Copperclad DC Electrodes

Part No.	Description	Application
24052003	5/16 in. (7.9 mm) x 14 in. (35.6 cm) CCDC Jointed	Provides continuous electrode feed and increased savings, especially in production operations. Suited for both hand held foundry applications and or automated gouging systems.
24062003	3/8 in. (9.5 mm) x 14 in. (35.6 cm) CCDC Jointed	
24064003	3/8 in. (9.5 mm) x 17 in. (43.2 cm) CCDC Jointed	
24082003	1/2 in. (12.7 mm) x 14 in. (35.6 cm) CCDC Jointed	
24084003	1/2 in. (12.7 mm) x 17 in. (43.2 cm) CCDC Jointed	
24104003	5/8 in. (15.9 mm) x 17 in. (43.2 cm) CCDC Jointed	
24124003	3/4 in. (19.05 mm) x 17 in. (43.2 cm) CCDC Jointed	

Note: Standard 100 pieces per carton unless noted.

## CutSkill Electrodes

Pointed Copperclad DC Electrodes		
Part No.	Description	Application
22033003C	3/16 in. (4.8 mm) x 12 in. (30.5 cm) CCDC Pointed	A standard, all purpose gouging electrode. Its controlled copper coating improves electrical conductivity (for more efficient, cooler operation) and helps maintain electrode diameter at the point of the arc.
22043003C	1/4 in. (6.4 mm) x 12 in. (30.5 cm) CCDC Pointed	
22053003C	5/16 in. (7.9 mm) x 12 in. (30.5 cm) CCDC Pointed	
22063003C	3/8 in. (9.5 mm) x 12 in. (30.5 cm) CCDC Pointed	

Note: Standard 50 pieces per carton unless noted. \* 100 pieces per carton.

Hollow Pointed Copperclad DC Electrodes		
Part No.	Description	Application
22043003HC	1/4 in. (6.4 mm) x 12 in. (30.5 cm) CCDC Pointed	General purpose electrodes having the same high quality blend of carbon and graphite used in other electrodes, but with a hole down the center of the electrode.
22053003HC	5/16 in. (7.9 mm) x 12 in. (30.5 cm) CCDC Pointed	
22063003HC	3/8 in. (9.5 mm) x 12 in. (30.5 cm) CCDC Pointed	

Note: Standard 50 pieces per carton.

Jointed Copperclad DC Electrodes		
Part No.	Description	Application
24064003C	3/8 in. (9.5 mm) x 17 in. (43.2 cm) CCDC Jointed	Provides continuous electrode feed for greatly increased savings, especially in production operations.
24084003C	1/2 in. (12.7 mm) x 17 in. (43.2 cm) CCDC Jointed	
24104003C	5/8 in. (15.9 mm) x 17 in. (43.2 cm) CCDC Jointed	
24124003C	3/4 in. (19.05 mm) x 17 in. (43.2 cm) CCDC Jointed	
24164003C	1 in. (25.4 mm) x 17 in. (43.2 cm) CCDC Jointed*	

Note: Standard 100 pieces per carton unless noted \* - 25 pieces per carton.

## Welding Carbon Products

### Carbon Plates and Carbon Rods

Wide Range of Applications to Control the Flow of Weld Metal

- Repair broken corners
- Repair broken gears
- Dams or molds for weld deposit

Eliminates the Need for Many Jigs and Fixtures

- Substantial time and labor savings



Ordering Information	
<b>Carbon Plate</b>	
48043012	1/4 in. (6.4 mm) x 12 in. (30.5 cm) x 12 in. (30.5 cm)
48063012	3/8 in. (9.5 mm) x 12 in. (30.5 cm) x 12 in. (30.5 cm)
48083012	1/2 in. (12.7 mm) x 12 in. (30.5 cm) x 12 in. (30.5 cm)
48123012	3/4 in. (19.05 mm) x 12 in. (30.5 cm) x 12 in. (30.5 cm)
48163012	1 in. (25.4 mm) x 12 in. (30.5 cm) x 12 in. (30.5 cm)
<b>Carbon rod</b>	
47123000	3/4 in. (19.05 mm) x 12 in. (30.5 cm)
47143000	7/8 in. (22.23 mm) x 12 in. (30.5 cm)
47164000	1 in. (25.4 mm) x 17 in. (43.2 cm)
47183000	1-1/8 in. (28.6 mm) x 12 in. (30.5 cm)
47203000	1-1/4 in. (31.8 mm) x 12 in. (30.5 cm)
47243000	1-1/2 in. (38.1 mm) x 12 in. (30.5 cm)
47323000	2 in. (50.8 mm) x 12 in. (30.5 cm)

## Arcair-Matic® N7500

### Automated Gouging System

The Arcair-Matic N7500 gouging system is highly productive for any metal fabrication operation where gouging and welding represents a large portion of the work schedule. This applies to almost all metals, including stainless steel, carbon, manganese, and chrome-moly steels.



AUTOMATED GOUGING

### Digital LCD Remote Pendant

- Ease of use – start/stop function, travel delay, electrode diameter
- Rough machining feature to stall the feed of the electrode to compensate for pitted area or out-of-round steel rolls, thereby maintaining the concentricity of the shaft/roll
- US Patent No. US 9101998 B2
- “Travel delay” function assures excellent groove geometry at the very beginning of the groove, thereby eliminating the need for a starting pad
- Shock-absorbent bumper
- Remote Pendant incorporates an emergency stop switch (E-Stop) when pressed in, will take precedence over any other “stop” signal and will drop out the engaged contactor in the power supply stopping the flow of current to the carbon electrode



### Torch Head

- Small and lightweight while accepting the wide range of Arcair jointed Jetrod Copperclad DC carbons, 5/16 in. (7.9 mm) through 3/4 in. (19.05 mm)
- Can be oriented 360 degrees in any direction giving flexibility to fit the application



### Digital Circuitry Control Box

- Redesigned digital circuitry control box
- A synergic mode ensures conformity to pre-determined, pre-selected groove depth and width specifications
- Can be used with CC/CV power supplies and the system utilizes the contactor in the welding power supply unit thereby eliminating the need for an external contactor used on prior models



### Complete N7500 Gouging System

#### Ordering Information

65991015	Includes remote pendant, control box, torch head, air regulator and electrode tube holder
----------	---

### System Cable Assembly Options\*

#### Ordering Information

##### 110V AC Power Supply Cable

96130304	10 ft (3 m)
----------	-------------

##### 220V AC Power Supply Cable

96130305	10 ft (3 m)
----------	-------------

##### Pendant Cable Assembly

96170069	14 in. (0.36 m)
96170070	15 ft (5 m)
96170071	25 ft (8 m)
96170072	50 ft (15 m)

##### Motor Cable Assembly

96130336	15 ft (5 m)
96130337	25 ft (8 m)
96130338	50 ft (15 m)

##### Power Supply Communication Cable Assembly

96130339	15 ft (5 m)
96130340	25 ft (8 m)
96130341	50 ft (15 m)

##### DC Power Cables

96130254	4 ft (1.2 m)
96130256	15 ft (5 m)
96130300	25 ft (8 m)

NOTE: Minimum 2 Power Cables Required

##### Air Hose Assembly

94396051	4 ft (1.2 m)
94396049	15 ft (5 m)
94396048	25 ft (8 m)

\*Must be ordered separately



## All Position Travel Systems

Arcair, the industry leader in air carbon-arc products partnered with leading travel system manufacturers to create the best all-around metal removal system providing superior performance, flexibility, versatility, and safety for your metal removal applications.

BUG-O® and GULLCO® tractors are ideal for out of position metal removal applications. Both systems incorporate an aluminum track that guides the tractor down the weld seam with the ability to keep the Arcair-Matic N7500 torch head on track with a mechanical rack device.

### Bug-O Travel System Packages

All travel systems include a complete N7500 Automated Gouging System

- Remote pendant
- Control box
- Torch head
- Arcair electrode tube holder
- Arcair air regulator



AUTOMATED  
GOUGING

Ordering Information		Bug-O Travel System Specifications						
Rigid - 110 VAC	71023140	<b>Carriage</b>	<b>Master Drive Unit</b>	<b>Arc Gouging Control Module</b>	<b>Arcair Mounting Group</b>	<b>Cable Mounting Assembly</b>	<b>Rail</b>	<b>On/Off Magnet</b>
Rigid - 220 VAC	71023141	MPD-1065 (12 in. Releaseable Carriage)	MPD-1000 (110 VAC)	AGS-1002	AGS-4172	BUG-2975	ARR-1080 (Heavy-Duty Aluminum Rail)	ARM-2010 (5 Magnets)
Flex - 220 VAC	71023143	MPD-1065 (12 in. Releaseable Carriage)	MPD-1002 (220 VAC)	AGS-1002	AGS-4172	BUG-2975	ARR-1080 (Heavy-Duty Aluminum Rail)	ARM-2010 (5 Magnets)
		FMD-1105 (HI-Flex Carriage w/ Handle & Clamp)	MPD-1000 (110 VAC)	AGS-1002	AGS-4172	--	FMD-2170 (HI-Flex Rail)	FMD-2010 (8 Magnets)
		FMD-1105 (HI-Flex Carriage w/ Handle & Clamp)	MPD-1002 (220 VAC)	AGS-1002	AGS-4172	--	FMD-2170 (HI-Flex Rail)	FMD-2010 (8 Magnets)

\* System Part No. includes the BUG-O items as noted along with the Arcair-Matic N7500 System.

### GULLCO Travel System Packages

All travel systems include a complete N7500 Automated Gouging System

- Remote pendant
- Control box
- Torch head
- Arcair electrode tube holder
- Arcair air regulator



Ordering Information		Gullco Travel System Specifications					
Rigid - 110 VAC	71023144	<b>Carriage</b>	<b>Rack Box</b>	<b>Rack Bar</b>	<b>Welding Gun Attachment</b>	<b>Track</b>	<b>Track Magnet Devices</b>
		GK-200-RHB-N (GULLCO "KAT" Variable Speed Travel Carriage - 110 VAC)	GK-171-650 (GULLCO Heavy Duty Rack Box)	GK-171-047-2 (GULLCO 18 in. Long Heavy Duty Square Rack Bar)	GK-165-047-2 (GULLCO 4-Motion Semi-Automatic Welding Gun Attachment)	GK-165-052-1 (GULLCO 96 in. Aluminum Alloy Standard Track)	GK-165-215 (6 GULLCO Track Magnet Devices)
		GK-200-RHC-N (GULLCO "KAT" Variable Speed Travel Carriage - 220 VAC)	GK-171-650 (GULLCO Heavy Duty Rack Box)	GK-171-047-2 (GULLCO 18 in. Long Heavy Duty Square Rack Bar)	GK-165-047-2 (GULLCO 4-Motion Semi-Automatic Welding Gun Attachment)	GK-165-052-1 (GULLCO 96 in. Aluminum Alloy Standard Track)	GK-165-215 (6 GULLCO Track Magnet Devices)

BUG-O is a registered trademark of the Weld Tooling Corporation. Gullco is a registered trademark of Gullco Enterprises Limited. The aforementioned registered trademarks are in no way affiliated with Arcair. Arcair is a registered trademark of ESAB.

## SLICE® Exothermic Cutting System

### Versatile - Unlike Any Other Cutting Technology

- Cuts right through hard-to-cut materials
  - Mild, stainless steel and alloy steels
  - Cast iron
  - Aluminum, magnesium and other non ferrous metals
  - Slag and refractory materials
  - Pierces through concrete or brick

### Fast Cutting Speeds

- No-preheat required
- Cut sooner and finish every job faster

### Comfortable and Easy to Use

- Pistol grip style handle
- Lightweight shield to protect the operator from heat and sparks
- Lever operated oxygen control

### Carry All Convenience

- Several portable SLICE packs to choose from
  - Utility Pack
  - Battery Pack
  - Industrial Pack
  - Complete Pack



EXOTHERMIC CUTTING

Specifications				
Input Voltage	Length of Power Cable & Oxygen Hose	Power Cable AWG Size	Certification Mark (Standards)	Weight
12 V Battery (not included)	10 ft (3 m)	#10	CE	#10 - 3.8 lb (1.7 kg)
		#6		#6 - 4.4 lb (2.0 kg)
		#1		#1 - 6.3 lb (2.9 kg)

Ordering Information	
03003012	SLICE Cutting Torch w/ #10 Power Cable (When Igniting w/ 12V Battery & Cutting w/o Power)
03003011	SLICE Cutting Torch w/ #6 (When Igniting 12V Battery & Cutting w/o Power)
03003010	SLICE Cutting Torch w/ #1 (Up to 200 A w/ Power)

Use 1/4" & 3/8" diameter of cutting rods by simply changing the collet nut and collet chuck

Lightweight shield to help protect the operator from heat and sparks

Easy to squeeze lever on the handle for easy oxygen control

Industrial grade oxygen hose 10 ft (3 m) length is standard



Pistol grip designed handle is comfortable and easy to use

## Tips for Using SLICE® Exothermic Cutting Equipment

### TIPS FOR CUTTING

Cutting procedures will vary from job to job. Study the cutting rates chart for specific cutting speeds.

Normal cutting is done by using a drag technique. Once the rod is in contact with the piece to be cut, drag the rod in the direction of the cut. If the operator cannot see the kerf, the speed of cut is too fast. If the rod is being used too rapidly the progress of the cut is too slow and the rod is being used without cutting. REMEMBER, the cutting rods consume as long as the oxygen is flowing. Maintain the proper travel speed at all times.

NOTE: Use a sawing motion when material to be cut is thicker than 1-1/2 to 2 inches to ensure a complete melt through.

Use a smooth motion to complete the cut. Be careful not to hit nearby material with the rod when cutting in “close quarters.” After completing the cut, release the oxygen control lever in the handle. THE CUTTING ROD WILL CONTINUE TO BURN AS LONG AS OXYGEN IS SUPPLIED. Hold the torch safely away from you until the rod cools.

### TIPS FOR PIERCING SURFACES

The SLICE Torch can be used to pierce solids. Special procedures must be used when piercing. When piercing, use a collet extension (and shield). This extension adds life to the torch and hand shield, and greatly improves operator safety and comfort. Always hold the torch at arm’s length and wear plenty of protective clothing, eye and ear protection. Cutting rods can get stuck inside the pierced hole. If possible, remove the cutting rod from the hole before releasing the oxygen lever.

With any thermal cutting equipment blowback is most likely to occur when the user is piercing holes. Cutting rods may burn unevenly. Slowly swirl the cutting rod as it enters a pierced hole. Cutting rods may burn out on the sides. Correct the problem by removing the cutting rod from the pierce point, shut the oxygen off, and replace the cutting rod.

To pierce follow these steps:

- Strike cutting rod on striker.
- Hold torch at arm’s length
- Keep the cutting rod at a 90° angle (perpendicular) to the pierce point
- Slowly push cutting rod in at pierce point until you are at proper depth or until you have achieved burn through

The pierce procedure is also used to cut concrete. By piercing a series of holes where a user wants to cut concrete, the concrete becomes easier to fracture. This helps reduce the time it would take to actually cut the concrete.

### OXYGEN USAGE

This cutting process uses standard industrial grade oxygen to support the exothermic reaction and to remove the molten metal. All SLICE equipment uses standard oxygen fittings. The most commonly recommended operating pressure is 80 psi. Applications such as cutting material sections 3 in. (7.6 cm) and thicker might require higher operating pressures. Pressures as low as 40 psi have been used to perform operations such as washing off rivet heads and scarfing out small cracks for repair.

The oxygen consumption rate for the SLICE cutting rods at 80 psi is 7 to 7.5 cfm for the 1/4 in. (6.35 mm) diameter cutting rods and 11 to 12 cfm for the 3/8 in. (15.87 mm) diameter cutting rods. This rate will vary if a different operating pressure is used.

### ROD BURNTIME

Listed are the approximate burntimes for the various SLICE rod diameters and lengths:

- 1/4 in. x 22 in. (6.4 X 559 mm) . . 40 - 45 seconds
- 1/4 in. x 44 in. (6.4 X 1118 mm) 80 - 90 seconds
- 3/8 in. x 18 in. (9.5 X 457 mm) . . 30 - 35 seconds
- 3/8 in. x 36 in. (9.5 X 914 mm) . . 60 - 70 seconds

### APPLICATION DATA

The best techniques for the SLICE equipment will change from job to job. The enclosed charts present the results of extensive testing of the SLICE Torch. Four things contribute to good cutting:

- 1) Electrical current
- 2) Type of material being cut
- 3) Environmental conditions
- 4) Experience of the operator(s)

These data result from studies of the first two (2) items in this list. Since data were collected in a laboratory, actual results obtained will vary because of changes in the environment. Too, these tests were conducted by highly experienced users. The way in which you use the SLICE Torch will also cause your results to vary.

In any application, some adjustments in operating conditions are necessary. The charts are presented only as a guideline. Results will vary. You can approximate these results by using the data presented as a starting point, then adjusting for your job.

Here is a sample of some cutting rates that can be obtained using the SLICE equipment. Cutting rates in this chart were obtained using 80 psi oxygen pressure, battery ignition (no power cutting) and 1/4 in. x 22 in. (356 x 559 mm) cutting rods. These cutting rates will vary when using different rods, when cutting with power or using a different oxygen pressure. This chart does not represent all materials SLICE will cut nor all thicknesses used in fabrication. When cutting composite materials or metals not listed, locate the listed type that most closely matches the metal to be cut. This information is only meant as a reference to the efficiency and versatility that a user can realize using the SLICE equipment.

Cutting Rates						
Material Being Cut	Thickness		Cut/in Rod		Cut Speed	
	in.	cm	in.	cm	in/min	cm/min
Carbon Steel	1/8	.318	2.25	5.7	72	183
	1/4	.635	1.50	3.8	52	132
	3/8	.953	1.38	3.5	42	106
	1/2	1.27	1.25	3.2	35	89
	3/4	1.91	0.75	1.9	22	56
Stainless Steel	1/8	.318	2.00	5.1	65	165
	1/4	.635	1.13	2.9	36	91
Aluminum	1/4	.635	1.75	4.4	58	147
	3/8	.953	1.25	3.2	38	97
	3/4	1.91	0.75	1.9	23	58

*This data is the result of averaging lab tests. The actual results will vary.*

## SLICE® Battery/Utility Pack

Go anywhere and cut, burn, or pierce virtually any metallic, non-metallic or composite material with this exothermic cutting pack. Comes with all the necessary equipment and cutting rods required to do cutting when combined with standard industrial grade oxygen to support the exothermic reaction and to remove the molten metal.



- New heavy-duty storage case to hold/store the equipment when not in use
- Improved torch handle and rubber shield to improve the operator's grip and provide protection from molten spray when piercing
- Improved striker assembly that incorporates a slide mechanism that allows the operator to only expose a small portion of the ignition bar (copper), which increases the life of the striker copper bar

### Battery Pack Only:

- Improved battery ignition source with improved features over prior model
  - Faster recharging of a “dead” battery
  - Better visual “gas gauge” indicating battery condition
  - Over-charging safe guard

Specifications				
Input Voltage	Length of Power Cable & Oxygen Hose	Power Cable AWG Size	Certification Mark (Standards)	Weight
120 V AC 60 Hz 220 V AC 50 Hz (Battery Pack)	10 ft (3 m)	#10	CE	Battery Pack 28 lb (12.7 kg) Utility Pack 21 lb (9.5 kg)
Output Voltage	Type of Battery	Recharge Time	Exothermic Cutting Rods	Dimensions L x W x H
12VDC	Seal lead acid	6 h (fully drained)	1/4 in. x 22 in. Uncoated – 25 Pcs	22.25 x 20 x 5.5 in. (565 x 508 x 140 mm)

Ordering Information	
63991041	SLICE Battery Pack – 120 V AC 60 Hz
63991044	SLICE Battery Pack – 220 V AC 50 Hz
63991047	SLICE Utility Pack

## SLICE® Battery Ignition Source

The improved battery ignition source features faster recharging, better visual gas gauge and over-charging safe guard.

Accepts the SLICE cutting torch power connection that has the twist-lock power pin and the SLICE Striker Assembly that completes the circuit when the SLICE rod held in the cutting torch comes in contact with the Striker copper bar. With oxygen flowing through the torch and cutting rod the exothermic reaction begins and cutting can start. Simply release the oxygen lever on the torch to stop the burn.



- All connections to the battery ignition source are labelled for ease of use
- Illuminated lights “GAS GAUGE” signifies the level of the battery current output to ignite the cutting rod
- Experienced operators can expect to achieve 115+ ignitions from a fully charged battery
- Charging time to bring a fully drained battery up to a fully charged status is 6 hours

Specifications				
Input Voltage	Internal Battery Display	Charging Mode	Certification Mark (Standards)	Weight
22-30 V DC	LED	Constant Volt-age	CE	7.1 lb (3.22 kg) Battery Case & Power Adapter
Output Voltage	Type of Battery	Adapter Input	Adapter Output	Dimensions L x W x H
12 V DC	Seal lead acid	100 – 240 VAC 50 – 60 Hz 1.4 A Max	24 V DC, 2.7 A	6.4 x 4.6 x 7.4 in. (163 x 117 x 188 mm)

Ordering Information	
96076040	SLICE Battery Ignition Source
96076041	Power Adapter w/ NAM Power Lead

EXOTHERMIC CUTTING

## SLICE® Industrial Pack

A self-contained cutting system lends itself well for maintenance/repair inside of manufacturing facilities.

- Improved torch handle and rubber shield to improve the operators grip and provide protection from molten spray when piercing
- Improved striker assembly that incorporates a slide mechanism that allows the operator to only expose a small portion of the ignition bar (copper) which increases the life of the striker copper bar
- Improved battery box with improved features over prior model
  - Faster recharging of a “dead” battery
  - Better visual “gas gauge” indicating battery condition
  - Over-charging safe guard
- Storage shelf on the cart to place a 12V battery for the power to ignite the SLICE rod and begin exothermic cutting action (12V battery not included with system)
- System includes a battery charger mounted on the cart to recharge the 12V battery as needed



## SLICE® Complete Pack

A self-contained cutting system lends itself well to the emergency/forced entry type cutting situations where seconds count.

- Improved torch handle and rubber shield to improve the operators grip and provide protection from molten spray when piercing
- Improved striker assembly that incorporates a slide mechanism that allows the operator to only expose a small portion of the ignition bar (copper), which increases the life of the striker copper bar
- Improved battery box with improved features over prior model
  - Faster recharging of a “dead” battery
  - Better visual “gas gauge” indicating battery condition
  - Over-charging safe guard



**EXOTHERMIC CUTTING**

Specifications				
Input Voltage	Length of Power Cable & Oxygen Hose	Power Cable AWG Size	Certification Mark (Standards)	Weight
120 V AC 60 Hz	10 ft (3 m)	#10	CE	81.2 lbs (36.8 kg)
Output Voltage	Exothermic Cutting Rods			Dimensions L x W x H
12 V DC	1/4 in. x 22 in. Uncoated – 25 Pcs			20-5/8 x 48-3/8 x 20 in. (524 x 1229 x 508 mm)

Ordering Information	
63991045	SLICE Industrial Pack – 120 V AC 60 Hz

Specifications				
Input Voltage	Length of Power Cable & Oxygen Hose	Power Cable AWG Size	Certification Mark (Standards)	Weight
120 V AC 60 Hz 220 V AC 50 Hz	10 ft (3 m)	#10	CE	With Cylinder 70 lb (31.75 kg) Without Cylinder 39.05 lb (17.71 kg)
Output Voltage	Recharge Time	Exothermic Cutting Rods		Dimensions L x W x H
12 V DC	6 h (fully drained)	1/4 in. x 22 in. Uncoated – 25 Pcs		With Cylinder: 15 x 27 x 8 in. (400 x 689 x 206 mm) Without Cylinder: 15 x 25 x 8 in. (400 x 638 x 206 mm)

Ordering Information	
63991040	SLICE Complete Pack – 120 V AC 60 Hz
63991042CE	SLICE Complete Pack – 220 V AC 50 Hz

## SLICE® Striker Assembly



The SLICE Striker comes standard with a #10 AWG Power Cable with a twist-lock brass pin that can connect to the SLICE battery ignition source. The same twist-lock pin can be inserted into the mating receptacle on a plier type clamp found in the SLICE Utility Pack (please see separate fact sheet for details).

- Improved striker assembly that incorporates a slide mechanism that allows the operator to only expose a small portion of the ignition bar (copper), which increases the life of the striker copper bar
- Robust handle insulator material that can handle impact with the ground and high temperature rating

Specifications		
<b>Length of Power Cable &amp; Oxygen Hose</b>	<b>Power Cable AWG Size</b>	<b>Certification Mark (Standards)</b>
10 ft (3 m)	#10	CE
<b>Weight</b>	<b>Dimensions L x W x H</b>	
1.2 lb (.54 kg)	9.5 x 1.5 x 1.75 in. (241.3 x 38 x 44.5 mm)	
Ordering Information		
72012010	SLICE Striker Assembly	

## SLICE® Cutting Rods

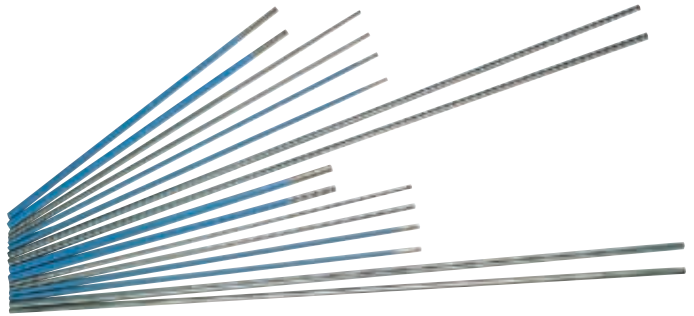

Unlike any other cutting process used today, SLICE systems can cut, burn or pierce virtually any metallic, non-metallic or composite material. Specially designed flux-coated cutting rod, patented single piece construction maintains the balance necessary to sustain the exothermic reaction.

- Specially designed cutting rod
- One piece patented construction maintains the balance necessary to sustain the exothermic reaction
- Cutting rod sustains the burn without constant electrical power once ignited

Ordering Information	
42049003	SLICE Exothermic Cutting Rods, Flux Coated, 1/4 x 22 – 100 Pcs
42049002	SLICE Exothermic Cutting Rods, Flux Coated, 1/4 x 22 – 25 Pcs
43049009	SLICE Exothermic Cutting Rods, Uncoated, 3/8 x 36 – 25 Pcs
43049007	SLICE Exothermic Cutting Rods, Uncoated, 3/8 x 18 – 50 Pcs
43049002	SLICE Exothermic Cutting Rods, Uncoated, 1/4 x 22 – 25 Pcs
43049005	SLICE Exothermic Cutting Rods, Uncoated, 1/4 x 44 – 25 Pcs
42049005	SLICE Exothermic Cutting Rods, Flux Coated, 3/8 x 18 – 50 Pcs
43049003	SLICE Exothermic Cutting Rods, Uncoated, 1/4 x 22 – 100 Pcs
94463032	3/8 in. Collet Conversion Kit

EXOTHERMIC CUTTING

# MAJOR UPGRADE: ARCAIR® SLICE® EXOTHERMIC CUTTING SYSTEM.

The fastest way to cut, burn or pierce virtually any metallic, nonmetallic or composite material. SLICE cuts anything put in front of its 8,000°F to 10,000°F flame, including steel, aluminum, cast iron, brass, nickel, concrete or firebrick.

The portability and cut-anything capabilities of SLICE systems make them preferred tools for forcible entry (fire and rescue), heavy equipment repair and maintenance, steel erection, bridge construction, and scrap and demolition work.

## SLICE ENHANCEMENTS.

- More-ergonomic torch grip and oxygen flow lever.
- Stronger connection between grip and rubber shield.
- New striker assembly extends striker life by exposing ignition bar in small increments.
- Improved 12V ignition source for faster recharging of a dead battery, overcharging safeguard and a better visual indication of battery condition.

## FOUR SLICE PACK OPTIONS.

### 1. SLICE Utility Pack.

Includes everything required for cutting except the 12V battery and oxygen cylinder.

### 2. SLICE Battery Pack.

Includes improved 12V ignition source. No cylinder.

### 3. SLICE Complete Pack.

Includes improved 12V ignition source and 55-cu.-ft. oxygen cylinder and oxygen regulator. Metal carrying case makes it well-suited for forcible-entry situations when seconds count.

### 4. SLICE Industrial Pack.

Cart accommodates a large oxygen cylinder to extend cutting time, and a 12V AC battery charger.



## Sea Torch® “Combination Torch”

Underwater Cutting & Welding Torch

### One-piece Body Construction

- Fully insulated electrically for safety in normal operation
- Prohibits oxygen leakage in the torch body
- Bright orange for high visibility to the diver

### Combination Torch

- Torch can be used for oxygen-arc cutting
- Underwater welding

### Tapered Collet Body

- Brings the bare surface of an electrode into contact for the entire length of the collet
- Solid grip and increased contact area decreases the risk of arcing between the collet and electrode

### Equipped with a Spark Arrestor

- Spark arrestor located behind the collet for safe operation
- Ball check valve in the torch handle gives additional protection



## Underwater Cutting Electrodes

### Exothermic Cutting Electrodes

- Exothermic cutting electrodes only require current to ignite the electrode and once ignited the rod will continue to burn as long as there is oxygen flowing

### Water-proof Coating

- All cutting electrodes are coated with a water-proof coating



Specifications	
<b>Length of Power Cable</b>	
10 ft (3 m)	
<b>Weight (with cable)</b>	<b>Dimensions (length)</b>
4.5 lbs (2.04 kg)	8.75 in. (22.2 cm)

Ordering Information	
42066006	Sea-Jet Cutting Electrodes, 3/8 x 18 – 50 Pcs
42075005	Sea Dragon Cutting Rod, 3/8 x 18 – 50 Pcs

Ordering Information	
14050126	Sea Torch with 3/8 in. (9.5 mm) Cutting Collet

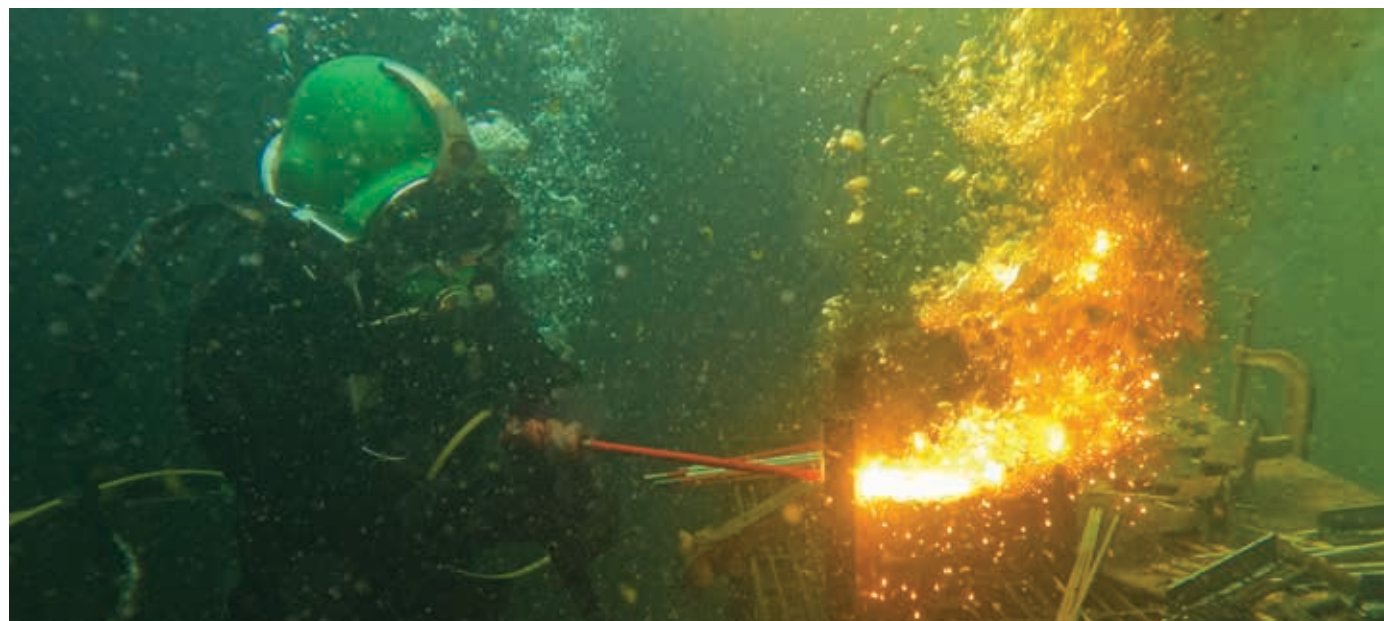

UNDERWATER CUTTING & WELDING





## Sea-Stinger® II Torch

Underwater Welding Torch



### Lightweight and Durable

- Proven design that gives the diver-welder an easy to use electrode holder
- Repairable replaceable cable and internal parts extend its service life

### Accepts Several Different Diameter of Welding Electrodes

- 1/8" (3.2 mm), 5/32" (4.0 mm) and 3/16" (4.8 mm) welding electrodes

## Underwater Welding Electrodes

### Excellent Bead Contour

- All position, flux coated SMAW electrode

### Fillet Welds are Flat with Good Base Metal Wetting

- Helps keep undercut to a minimum

### Easy Slag Removal

- Keeps chipping and grinding to a minimum
- Lower risk of slag inclusions

### Produced Welds Which Pass Bend and X-ray Requirements

- As defined by the AWS D3.6 specification for underwater welding



Specifications	
<b>Length of Power Cable</b>	
10 ft (3 m)	
<b>Weight (with cable)</b>	<b>Dimensions (length)</b>
3.65 lbs (1.66 kg)	6 in. (15.24 cm)

Ordering Information	
14050128	Sea-Stinger II Underwater Welding Torch

Ordering Information	
42024002	Sea-Weld Welding Electrodes, 1/8 x 14 – 150 Pcs
42984004	Sea-Weld Welding Electrodes, 5/32 x 14 – 100 Pcs
42034007	Sea-Weld Welding Electrodes, 3/16 x 18 – 75 Pcs

PROTEX® CHEMICALS



PROTEX  
CHEMICALS

## Protex Original Anti-Spatter

First Choice for Big Jobs in Welding, Cutting, or Gouging

- Reduces spatter and protects from slag spoiling clean edges
- Protects the parent metal, fixtures, large weldments and jigs from spatter and slag
- Use it during heat treating to protect surfaces from scale

Environmentally Safe

- Non-toxic and non-flammable



Ordering Information	
53011000	Protex Original, 1 gal (3.8 L), Case of 4
53015000	Protex Original, 5 gal (19 L)
53018000	Protex Original, 55 gal (208 L), Drum

## Protex Extra Anti-Spatter

Reduces Spatter Adhesion to Parent Metal

- Spray or brush onto the parent metal and you are ready to weld in less than one minute

Environmentally Safe

- Non-toxic and non-flammable



Ordering Information	
53024500	Protex Extra, 24 oz (710 mL), Case of 12
53014500	Protex Extra, 1 gal (3.8 L), Case of 4
53015500	Protex Extra, 5 gal (19 L)
53018500	Protex Extra, 55 gal (208 L), Drum

## Protex Plus Anti-Spatter

### Reduces Adhesion to Parent Metal

- Spray onto the parent metal to reduce spatter or slag from adhering

### Environmentally Safe

- An aerosol anti-spatter
- Contains no chlorinated solvents, fluorocarbons, silicones

#### Ordering Information

57021106	Protex Plus, 16 oz (473 mL), Case of 12
----------	---



## Protex Tip Dip Anti-Spatter

### Protects Spatter Build-up on GMAW Nozzles and Contact Tips

- High heat resistance to minimize spatter build-up

**Note:** Allow nozzles to cool below red heat before dipping (ignition may occur above 1000°F).

### Environmentally Safe

- Non-toxic



#### Ordering Information

57021105	Protex Tip Dip, 16 oz (454 g), Case of 12
----------	---

## Protex Alclean

### Removes oxides, dirt and grime from aluminum plate, castings and joint areas prior to welding

- Spray or brush on large areas

**Note:** may turn 2000 Series aluminum black.



#### Ordering Information

57021200	Protex Alclean, 1 qt (946 mL), Case of 12
57014000	Protex Tip Dip, 1 gal (3.8 L), Case of 4



# // MANUAL PLASMA







LEAN.

MEAN.

THE PORTABLE PLASMA CUTTER WITH MORE  
POWER THAN YOU THOUGHT POSSIBLE.

**THERMAL  
DYNAMICS**  
AN ESAB BRAND



# CONTENTS

Plasma Cutting Process.....211

## CUTTING MACHINES

Cutmaster® 30+ .....213  
 Cutmaster® 40 .....214  
 Cutmaster® 58 .....214  
 Cutmaster® 60i .....215  
 Cutmaster® 82 .....217  
 Cutmaster® 102 .....217  
 Cutmaster® 152 .....218  
 PAK® 200i .....218

## PLASMA TORCHES

1TORCH® SL60 .....219  
 1TORCH® SL100 .....219  
 1TORCH® Mechanized SL100, Automation SL100SV .....219  
 1TORCH® Consumables .....220  
 1TORCH® Consumables Parts Application Guide .....220

## PLASMA ACCESSORIES

Plasma Accessories .....221



Dr. James Browning, Founder



**1957**

Dr. James Browning & Merle Thorpe found Thermal Dynamics.

**1970**

First PAK® unit-power supply, PAK 40, cooling system, and console combined into one unit.

**1975**

PAK 44 incorporated plug-in relays, torch auto-pilot, and constant current.

**1980**

First single phase machine introduced, PAK 5.

**1982**

PAK-3, the first PAC system to use air as plasma gas, for cutting gauge thickness material.

**1990**

Plasma gouging introduced, PAK 15XC

**1997**

PAKMaster® XL series and the Econopak® provide more portability.

**1998**

The Drag Gun® introduced as the first cutting system with a built-in air compressor.

**1999**

PAKMaster® XL Plus Series introduced.

# AT THE FOREFRONT OF PLASMA CUTTING INNOVATION



FIG. 9



**2000**

Cutmaster® 50 & Sure Lok® RPT replacement torches introduced.

**2002**

T Torch® and ATC® connection were introduced with SureLok® technology. First non-High Frequency system introduced with the Cutmaster® 38

**2004**

Cutmaster 1Series®; 51/81/101 launched.

**2008**

Cutmaster TRUE™ Series; 39/52/82/102/152 launched.

**2011**

Cutmaster 42 with SL40 torch utilizing V2S technology.

**2014**

Thermal Dynamics becomes An ESAB Brand

**2017**

ESAB launches the Thermal Dynamics Cutmaster 60i

**2018**

Cutmaster 58 is introduced.

**2020**

Cutmaster 40 is introduced.

FIG. 1

## Plasma Cutting Process

### From the Market Leaders

Since Thermal Dynamics® developed the plasma arc process in 1953 and incorporated in 1957, we have introduced a number of innovations to ensure peak performance in plasma cutting and gouging.

Today, ESAB's product line includes the full range of Thermal Dynamics systems designed to meet your specific needs and applications.

### Process Description

Plasma arc cutting is a relatively simple operation and widely accepted for cutting ferrous and non-ferrous metals. The plasma arc's straight, narrow, column-like shape and high current density allow the operator to achieve cut consistency without maintaining a constant distance between the nozzle and the workpiece.

Plasma cutting involves using a torch, compressed gas, and a source of electric power to create a constricted arc that melts a localized area of metal and removes the molten material with a high-velocity jet of hot, ionized gas.

During plasma cutting, a compressed gas and an electric arc are simultaneously passed through a small orifice, which is typically 0.040 in. (1.0 mm) to 0.125 in. (3.18 mm) in diameter. An electric arc heats the gas to a plasma state at a temperature as high as 50,000°F (27,760°C). This super-heated plasma jet is directed to the area to be cut, and the jet melts a path through the metal. Because it is a melting process, plasma cutting can cut almost any commercially used metal.

Plasma gouging is a variation of the plasma cutting process. The torch nozzle configuration is designed to produce a lower velocity, broader arc. Rather than cutting completely through the metal, the torch is held at an angle so the arc gouges a U-shaped groove in the metal.

Plasma cutting can be accomplished manually or mechanically. In mechanical setups, a plasma torch is driven by an automatic machine that is typically regulated by a computer numerical control (CNC) to cut a predetermined shape. This section focuses on manual plasma cutting, in which the plasma torch is manipulated by hand to perform a variety of metal cutting tasks.

Manual systems are available in a variety of sizes. Generally rated in amperage output or cutting capacity, the units range from about 15 to 300A output, encompassing a cutting capacity ranging from 1/4 in. (6.35 mm) to approximately 4 in. (101.6 mm).

Manual units can also be divided into two general categories. Stationary or console systems generally are designed to remain fixed in one place, although most are equipped with wheels that make it possible to move them around a shop. Portable systems are designed to be carried around by one or two workers, allowing them to move the system where it is needed rather than taking materials to be cut to one location.

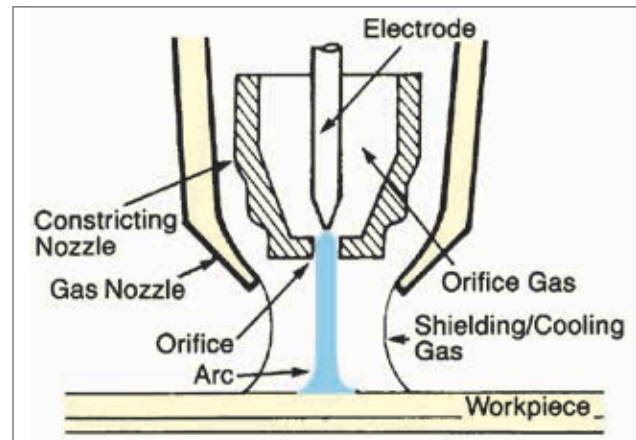

Plasma Arc Cutting

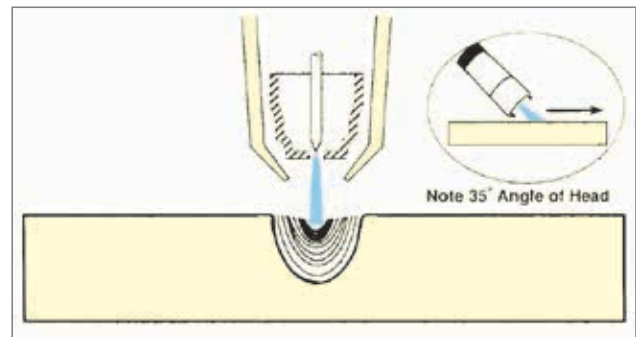

Plasma Arc Cutting

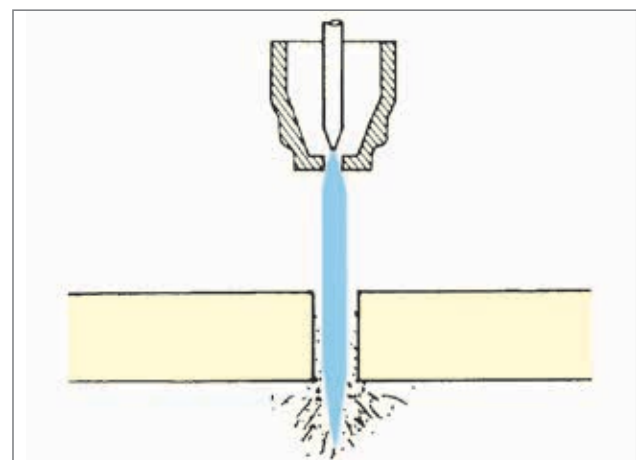

Plasma Arc Gouging

## Plasma Cutting Process

### The Cutting Torch

One of the most important considerations in choosing a system is the front-end design of the plasma cutting torch, because it controls the cut and most heavily influences the operating costs of the setup. If reaching tight places is important, a torch with a small or narrow front end is a good choice. A smaller front end may also be a better choice in applications that require a clear line of vision to follow a cut line, because a larger front end could obscure vision.

In addition to the up-front costs for nozzles, electrodes, and other front-end parts, you should consider the durability of the parts and the life in arc hours you can expect from the nozzle and electrode combination. These factors are better indicators of operating costs than are the prices of the parts alone.

Plasma cutting torch parts are generally made to very high tolerances. Make sure that any replacement parts you use are made to proper specifications. The wrong replacement parts can result in poor performance and damage to the torch head, which could require an expensive repair.

### Recommended Cutting Gases

**Compressed Air** is the most commonly used gas for lower current plasma cutting and works well for most metals from gauge thickness to 1 in. (25.4 mm). It leaves an oxidized cut surface. Compressed air can also be used for plasma gouging on carbon steel.

**Nitrogen (N<sub>2</sub>)** is often used for higher current plasma systems and for cutting materials up to 3 in. (76.2 mm) thick. It produces excellent quality cuts on most materials.

**Argon-Hydrogen Mixtures (H-35)** are generally used for cutting stainless steel and aluminum. They produce a clean, high quality cut face. Argon-Hydrogen is required for mechanized cutting of any material more than 3 in. (76.2 mm) thick. This mixture also provides an excellent gas for plasma gouging on all materials.

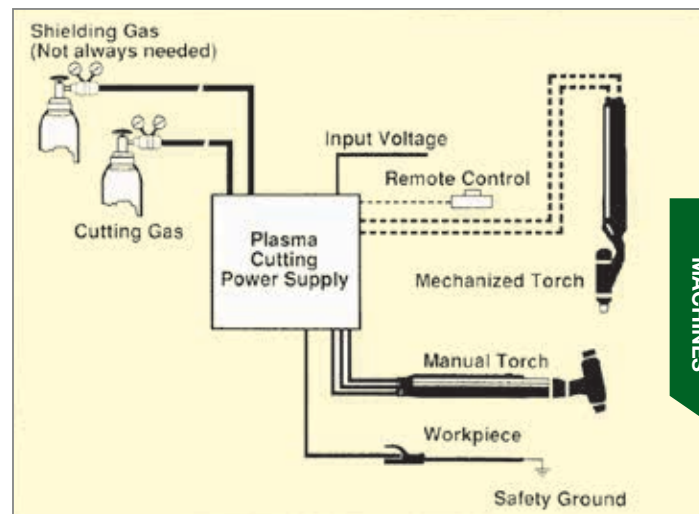

Finally, the best way to evaluate a manual plasma cutting system for your application is to ask for a demonstration. Many of the factors that determine which unit is right for you become obvious when you see the unit demonstrated in your own shop. Pay particular attention to cut speed, quality, ease of use, and portability, if that is an issue. If access is limited to an area to be cut, make sure that the cutter you evaluate can do the job.

### Important Product Safety

Sound common sense procedures must be followed for personal protection and operating efficiency when using manual plasma cutting equipment. Always comply with the manufacturer's recommendations for operating and maintaining the equipment, as set forth in the instructions provided with each unit. Also, be certain to use all applicable safety precautions, as described in Precautions and Safe Practices for Arc Welding, Cutting and Gouging (F-52-529), which is available by contacting ESAB at 1-800-ESAB.123 or visiting [esabna.com](http://esabna.com).

## Cutmaster® 30+

Highest Power-To-Weight Ratio in its Class

CUTTING MACHINES



- Portable and durable with three handles and lightweight, industrial all-weather housing
- Bright 4.3 in. TFT LCD display with glove-friendly adjustment knob simplifies use and provides greater control and flexibility
- Dual input 110-240 V, 1 ph power with automatic voltage detection that sets max output amperage
- Comes with industrial SL60 1Torch featuring 2T/4T function, safety trigger lock, and double-tap trigger to conserve bottled air
- Switch between normal and grate cutting modes
- Automatic air pressure detection and post-cut air purge to expand consumable life
- 40% duty cycle @ 30 A, 100% @ 20 A
- Cutmaster Black Series consumables included for up to 60% longer life
- Industry leading 3-year warranty on power supply and 1-year warranty on torch and leads

### Specifications

Input Voltage	Recommended Generator Size	Open Circuit Voltage	Amperage Output
110 – 240 VAC +/- 10%, 1 ph, 50/60 Hz	4.5 kW (full output)	290 V	10 – 30 A, continuously adjustable
Rated Duty Cycle	Amperage Draw	Input Power Cable and Plug	Work Lead with Ground Clamp
40% @ 30 A 100% @ 20 A	19 A @ 230 V 20 A @ 120 V 1 ph (limited output)	4 m (13 ft) 10mm <sup>2</sup> work cable with 25 mm Dinse connection	4 m (13 ft) 10mm <sup>2</sup> work cable with 25 mm Dinse connection
Recommended Cut	Maximum Sever	Pierce Rating	Gas Requirements
up to 3/8 in. (10 mm)	5/8 in. (16 mm)	up to 3/8 in. (10 mm)	Compressed air
SL60QD Torch Duty Cycle	Air Flow Requirements (cutting & gouging)	Operating Input Air Pressure Range	Operating Temperature Range
100% at 30 A @ 350 scfh air flow	170 – 350 cfm (80 – 150 l/m)	90 – 125 psi (6.2 – 8.6 bar) (0.62 – 0.86 Mpa)	14 – 122° F (-10° – 50° C)
Torches	Power Supply Air Filter	Dimensions L x W x H	Weight (including torch)
SL60 1Torch (supplied)	Built-in	18.3 x 7.9 x 12.4 in. (465 x 200 x 315 mm)	24.25 lbs. (11 kg)

### Ordering Information

TD Cutmaster 30+ Package, 120 – 240 V 1 ph (NEMA 6-50 plug, 115 V adapters) CSA	1-3000-1
---	----------

*Cutmaster 30+ power supply, SL60 75° torch with lead, 3 m (10 ft) work lead with ground clamp, consumables kit, regional input power plugs per above, 1/4 in. NPT air fitting. Cutmaster 30+ is compatible with all 1Torch ATC torch connections.*



## Cutmaster® 40

Highest Power-To-Weight Ratio in its Class



- Built for portability and durability with the integral multi-handle design
- 40% Duty Cycle depending on application. Automatic voltage input detection from 110-240V and will automatically set the max output. 27 amps for 110 and 40 amps for 200-240V
- Industrial SL60 1Torch with ATC® (Advanced Torch Connector)
- Up to 1/2 in. (12 mm) recommended pierce and cut capacity with maximum sever of 1 in. (25 mm)
- Cutmaster Black Series electrode included for up to 60% longer life of consumable parts
- Industry leading 4-year warranty on power supply and 1-year warranty on torch

CUTTING  
MACHINES

Specifications									
Input Voltage	Recommended Cut	Maximum Sever	Duty Cycle	Open Circuit Voltage (OCV)	Pierce Rating	Max Amperage Output	Torch Air Pressure	SL60 Torch Duty Cycle	Min. Air Flow Requirements
110-240 VAC +/- 10%, 1 ph, 50/60 Hz	up to 1/2 in (12 mm)	1 in (25 mm)	40% @ 40 A 60% @ 30 A 100% @ 20 A	300 V	1/2 in (12 mm)	15 – 40 A continuously adjustable	90-125 psi (6.2-8.6 bar)	100% at 40 A @ 400 cfm (189 l/min) air	170 cfm (80 l/min)
Amperage Draw	Gouging Profiles	Output Range	Temp. Range	Recommended Generator	Gas Requirements	Dimensions L x W x H	Weight		
29 A @ 208 V 26 A @ 230 V 25.3 A @ 115 V	Tip A (SL60 torch only)	40 A (Max)	32° – 122° F (0° – 50° C)	8.0 kW	Compressed Air	18.1 x 7.9 x 12.8 in. (460 x 200 x 320 mm)	22 lbs. (10 kg)		
Ordering Information									
Cutmaster 40, SL40 75° hand torch, 15 ft. (4.5 m), 120/230 V, 1 ph									1-4000-1

Cutmaster 40 power supply, SL60 90° torch with lead, work lead with ground clamp, spare parts kit, input power adapters: 50A to 20A and 20A to 15A, 1/4" NPT air fitting with quick connect, and operating manual. Cutmaster 40 is compatible with all 1Torch ATC torch connections.

## Cutmaster® 58

Medium Duty, Portable Plasma Cutting System



- The Cutmaster® 58 is the most powerful 5/8 in. (16 mm) machine on the market today
- Cuts through mild and stainless steel, or aluminum up to 1 in. (25 mm) thick, 1/2 in. (13 mm) pierce rating
- Combines power with the well-known performance and features of the industry-leading 1Torch®
- 6.2 kW rated output, 60% duty cycle at 50A, available in either 208-480V or 600V system - either system is capable of being wired single or three phase
- Simple switch at the back of the system allows for low or high voltage applications and automatic voltage detection within each range
- Built for portability and durability with the integral multi-handle design

Specifications					
Input Voltage	Recommended Cut	Pierce Rating	Max Amperage Output	Output Power	Torch
208-230/460 V, 1/3 ph, 50/60 Hz 400 V, 3 ph, 50 Hz 600 V, 3 ph, 50/60 Hz	5/8 in. (16 mm)	1/2 in. (12 mm)	60 A	6.2 kW	SL60QD Air Pressure - 75 psi (5.2 bar) Consumption - 6.7 cfm (190 l/m)
Duty Cycle	Amperage draw	Maximum Cut	Dimensions L x W x H	Weight	
40% @ 60 A 60% @ 50 A 100% @ 30 A	45 A @ 230 V, 1 ph 24 A @ 230 V, 3 ph 16 A @ 460 V, 3 ph	1 in. (25 mm)	24 x 12 x 15 in. (610 x 305 x 381 mm)	43 lbs. (19.5 kg)	

Ordering Information			
Cutmaster 58, 20 ft. (6 m), SL60QD, 208-230 VAC	1-5830-1	Cutmaster 58, 20 ft. (6 m), SL60QD, 400-480 VAC	1-5830-2
Cutmaster 58, 20 ft. (6 m), SL60QD, 600 VAC	1-5830-5	Cutmaster 58, 50 ft. (15.2 m), SL60QD, 208-230 VAC	1-5831-1
Cutmaster 58, 50 ft. (15.2 m), SL60QD, 400-480 VAC	1-5831-2	Cutmaster 58, 50 ft. (15.2 m), SL60QD, 600 VAC	1-5831-5

Cutmaster 58 systems include: Power supply, torch, spare parts kit, input power cable, work cable and clamp.

## Cutmaster® 60i

The New Frontier in Plasma



CUTTING MACHINES

- Packed with power and offering the highest power-to-weight ratio in its class, the Cutmaster® 60i with SL60QD 1Torch® also has best-in-class cutting arc length and the most empowering and engaging user experience no matter the application
- Built for portability and durability with the integral multi-handle design, available in either a 1 phase or 3 phase unit
- Cutmaster MechPak is also available for easy integration into semi-automatic cutting processes (MechPak sold separately)
- 50% Duty Cycle at 60A with automatic multi-voltage detection from 208-480V
- Industrial SL60QD 1Torch quick disconnect with ATC® (Advanced Torch Connector) allowing selective replacement of either the torch handle assembly or the torch leads, using the patented SureLok® technology
- Up to 3/4 in. (20 mm) recommended cut capacity with maximum sever of 1-1/2 in. (38 mm) and 3/4 in. (20 mm) pierce capability
- High-visibility, oversized display with gas optimizer technology and consumables end-of-life indicator, makes setup and usage simple and productive
- Cutmaster Black Series electrode included for up to 60% longer life of consumable parts
- Industry leading 4-year warranty on power supply and 1-year warranty on torch

### Specifications

Input Voltage	Recommended Generator Size	Open Circuit Voltage	Amperage Output
208 – 480 VAC +/- 10%, 1 ph or 3 ph, 50/60 Hz	15 kW (full output)	300 V	10 – 60 A, continuously adjustable
Rated Duty Cycle	Amperage Draw	Input Power Cable and Plug	Work Lead with Ground Clamp
50% @ 60 A 60% @ 50 A 100% @ 40 A	43 A @ 208 V 1 ph / 26 A @ 208 V 3 ph 39 A @ 230 V 1 ph / 23 A @ 230 V 3 ph 19 A @ 480 V 1 ph / 11 A @ 480 V 3 ph	9 ft. (2.7 m) 1 ph 8 AWG 3/C with NEMA 6-50P plug 9 ft. (2.7 m) 3 ph 12 AWG 4/C cable without plug	20 ft. (6 m) #8 work cable with 50 mm connection
Recommended Cut	Maximum Sever	Pierce Rating	Gas Requirements
up to 3/4 in. (20 mm)	1-1/2 in. (38 mm)	3/4 in. (20 mm)	Compressed air
SL60QD Torch Duty Cycle	Air Flow Requirements (cutting & gouging)	Operating Input Air Pressure Range	Operating Temperature Range
100% at 60 A @ 400 scfh air flow	300 – 500 cfm (142 – 235 l/m)	90 – 125 psi (6.2 – 8.6 bar)	32 – 122° F (0° - 50° C)
Torches	Power Supply Gas Filtering Ability	Dimensions L x W x H	Weight
SL60QD 1Torch (supplied) SL60/SL100 1Torch SL100 Mechanized 1Torch SL100SLV Automated 1Torch	Particulates to 5 Microns	21.12 x 7.85 x 14.15 in. (536 x 199 x 593 mm)	37 lbs. (16.8 kg)

### Ordering Information

Cutmaster 60i, 1 ph with SL60QD 1Torch 20 ft. (6.1 m) 75° Head	1-5630-1X
Cutmaster 60i, 1 ph with SL60QD 1Torch 50 ft. (15.2 m) 75° Head	1-5631-1X
Cutmaster 60i, 3 ph with SL60QD 1Torch 20 ft. (6.1 m) 75° Head	1-5630-2X
Cutmaster 60i, 3 ph with SL60QD 1Torch 50 ft. (15.2 m) 75° Head	1-5631-2X

Cutmaster 60i systems include: power supply, SL60QD 75° torch with lead, 20 ft. (6.1 m) work lead with ground clamp, spare parts kit, operating manual, and filter wrench.

Cutmaster 60i is compatible with all 1Torch® ATC torch connections.

### SL60 Consumables

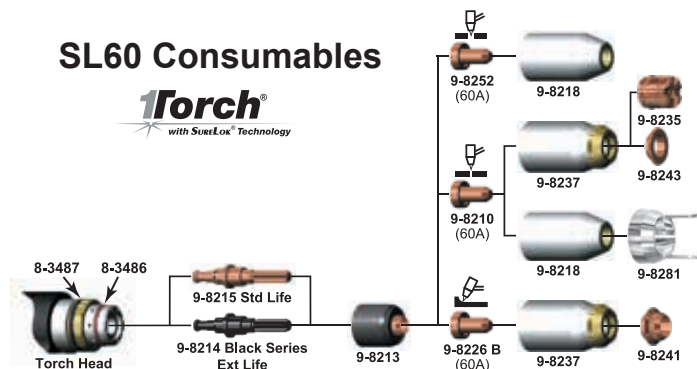



# WE'VE CREATED A CUTTING BEAST.



**THE FIERCEST PLASMA CUTTER IN ITS CLASS.**  
**KILLER POWER-TO-WEIGHT RATIO // INSANE CUTTING ARC**  
**VICIOUS TORCH // MONSTROUS DISPLAY**

Find out how you can unleash the Thermal Dynamics® **Cutmaster® 60i** at [esab.com](http://esab.com).

## Cutmaster® 82

Medium/Heavy Duty, Portable Plasma Cutting System



- The Cutmaster® 82 weighs in at only 43 lbs. (19.5 kg) while still offering superior cutting power
- Cuts 3/4 in. (20 mm) with a maximum capability of 1-1/2 in. (40 mm)
- Versatile 1Torch® with ATC® disconnect makes it easy to add lead extensions or convert to a machine torch
- True Guard roll bar provides easy transportation and protection for unmatched durability
- Auto Pilot Restart feature instantly reignites the pilot arc while cutting expanded metals

### Specifications

Input Voltage	Recommended Cut	Pierce Rating	Output Power	Max Amperage Output	Torch
208 – 230/460 V, 1/3 ph, 50/60 Hz 400 V, 3 ph, 50 Hz 600 V, 3 ph, 50/60 Hz	3/4 in. (20 mm)	5/8 in. (15 mm)	9 kW	80 A	SL60 Air Pressure - 70 psi (4.8 bar) 6.7 cfm (190 l/m)
Maximum Cut	Amperage Draw	Duty Cycle (@ 104°F/40°C)	Dimensions L x W x H	Weight	
1.5 in. (40 mm)	72 A @ 230 V, 1 ph 39 A @ 230 V, 3 ph 21 A @ 460 V, 3 ph	40% @ 80 A 60% @ 65 A 100% @ 55 A	24 x 12 x 15 in. (610 x 305 x 381 mm)	43 lbs. (19.5 kg)	

### Ordering Information

Cutmaster 82, SL60 75°, 20 ft. (6.1 m), 208-230 V, 1 ph	1-1130-1	Cutmaster 82, SL60 75°, 20 ft. (6.1 m), 460 V, 3 ph	1-1130-2
Cutmaster 82, SL60 75°, 20 ft. (6.1 m), 600 V, 3 ph	1-1130-5	Cutmaster 82, SL60 75°, 50 ft. (15.2 m), 208-230 V, 1 ph	1-1131-1
Cutmaster 82, SL60 75°, 50 ft. (15.2 m), 460 V, 3 ph	1-1131-2	Cutmaster 82, SL60 75°, 50 ft. (15.2 m), 600 V, 3 ph	1-1131-5

Cutmaster 82 systems include: power supply, torch, spare parts kit, input power cable, work cable and clamp, and an instructional DVD.

## Cutmaster® 102

Heavy Duty, Portable Plasma Cutting System



- The Cutmaster® 102 weighs in at 62 lbs. (28 kg) and provides 100 A of cutting power
- This unit combined with the 1Torch® has a maximum cut capacity of 1-3/4 in. (45 mm)
- Versatile 1Torch with ATC® disconnect makes it easy to add lead extensions or convert to a machine torch
- True Guard roll bar provides easy transportation and protection for unmatched durability
- Auto Pilot Restart feature instantly reignites the pilot arc while cutting expanded metals

### Specifications

Input Voltage	Recommended Cut	Pierce Rating	Output Power	Max Amperage Output	Torch
208 – 230/460 V, 1/3 ph, 50/60 Hz 400 V, 3 ph, 50 Hz 600 V, 3 ph, 50/60 Hz	1 in. (25 mm)	3/4 in. (20 mm)	12 kW	100 A	SL100 Air Pressure - 70 psi (4.8 bar) 7.5 cfm (212 l/m)
Amperage Draw	Maximum Cut	Duty Cycle	Dimensions L x W x H	Weight	
95 A @ 230 V, 1 ph 45 A @ 230 V, 3 ph 29 A @ 460 V, 3 ph	1 3/4 in. (45 mm)	60% @ 100 A 80% @ 80 A 100% @ 70 A	30 x 12 x 15 in. (762 x 305 x 381 mm)	62 lbs. (28.1 kg)	

### Ordering Information

Cutmaster 102, SL100 75°, 20 ft. (6.1 m), 208-230 V, 1 ph	1-1330-1	Cutmaster 102, SL100 75°, 20 ft. (6.1 m), 460 V, 3 ph	1-1330-2
Cutmaster 102, SL100 75°, 20 ft. (6.1 m), 600 V, 3 ph	1-1330-5	Cutmaster 102, SL100 75°, 50 ft. (15.2 m), 208-230 V, 1 ph	1-1331-1
Cutmaster 102, SL100 75°, 50 ft. (15.2 m), 460 V, 3 ph	1-1331-2	Cutmaster 102, SL100 75°, 50 ft. (15.2 m), 600 V, 3 ph	1-1331-5

Cutmaster 102 systems include: power supply, torch, spare parts kit, input power cable, work cable and clamp, and an instructional DVD.

## Cutmaster® 152 Extra Heavy Duty Cutting System



- The Cutmaster® 152, weighing only 62 lbs. (28 kg), offers multi-voltage 1-or 3-phase input capability and provides 120 A of cutting power for a 1-1/4 in. (30 mm) recommended cut and 2 in. (50 mm) maximum cut
- Comes standard with the 1Torch® providing you with the well known comfort and reliability famous throughout the industry
- Front Panel LEDs indicate status conditions for maximum efficiency and storage compartment for convenient access to spare parts and consumables
- True Guard roll bar provides easy transportation and protection for unmatched durability
- Auto Pilot Restart feature instantly reignites the pilot arc while cutting expanded metals

Specifications					
Input Voltage	Recommended Cut	Pierce Rating	Output Power	Max Amperage Output	Torch
208 – 230/460 V, 1/3 ph, 50/60 Hz 400 V, 3 ph, 50 Hz 600 V, 3 ph, 50/60 Hz	1-1/4 in. (30 mm)	1 in. (25 mm)	15.4 kW	120 A	SL100 Air Pressure - 70 psi (4.8 bar) 7.5 cfm (212 l/m)
Amperage Draw	Maximum Cut	Duty Cycle	Dimensions L x W x H	Weight	
120 A @ 230 V, 1 ph 56 A @ 230 V, 3 ph 37 A @ 460 V, 3 ph	2 in. (50 mm)	80% @ 120 A 100% @ 100 A	30 x 12 x 15 in. (762 x 305 x 281 mm)	62 lbs. (28.1 kg)	

Ordering Information				
Cutmaster 152, SL100 75°, 20 ft. (6.1 m), 208–230 V, 1 ph	1-1730-1	Cutmaster 152, SL100 75°, 20 ft. (6.1 m), 460 V, 3 ph	1-1730-2	
Cutmaster 152, SL100 75°, 20 ft. (6.1 m), 600 V, 3 ph	1-1730-5	Cutmaster 152, SL100 75°, 50 ft. (15.2 m), 208–230 V, 1 ph	1-1731-1	
Cutmaster 152, SL100 75°, 50 ft. (15.2 m), 460 V, 3 ph	1-1731-2	Cutmaster 152, SL100 75°, 50 ft. (15.2 m), 600 V, 3 ph	1-1731-5	

Cutmaster 152 systems include: power supply, torch, spare parts kit, input power cable, work cable and clamp, and an instructional DVD.

## PAK® 200i Manual Air-Plasma Cutting and Gouging System



- Capable of hand cutting at 200 A with the ability to cut up to 2-3/4 in. (70 mm) on mild steel; at full output this unit will cut 10 ipm (254 mm/min) on 2 in. (51 mm) carbon steel
- 100% duty cycle at full output
- Dual Gas Capability – the dual gas system ensures superior quality and performance on ferrous and non-ferrous materials (Plasma Gas: Air, ArH2, Secondary Gas: Air, N2)
- High Gouging Removal Rate – with the ability to remove up to 25 lbs. (11.3 kg) of carbon steel per hour
- Tip Saver for Optimal Tip Life – this ensures that any accidental contact between the tip and the work at high power levels will not damage the tip

All PAK 200i systems include power supply, torch and leads, spare parts kit, 25 ft. (7.6 m) work cable and clamp, and torch coolant.

Specifications						
Input Voltage	Output Power	Recommended Cut	Maximum Cut	Pierce Rating	Duty Cycle	Torch
380 – 415 V, 3 ph, 50/60 Hz / 480 V, 3 ph, 50/60 Hz	40 kW	1-1/2 in. (40 mm)	2 3/4 in. (70 mm)	1 1/4 in. (32 mm)	100% @ 200 A	PCH200 Hand/Machine
Output Current	Amperage Draw	Specifications	Dimensions L x W x H	Weight		
35-200 A	60 A @ 380 V 57 A @ 400 V 47 A @ 480 V	Plasma Gas - Air, ArH2, N2 Secondary Gas - Air, N2	40.6 x 48 x 27.5 in. (1031 x 1219 x 698 mm)	490 lbs. (222 kg) w/o torch Fully Assembled Power Supply		

Ordering Information						
PAK 200i - 70° Torch, 25 ft. (7.6 m), 480 V	1-2239	PAK 200i - 70° Torch, 50 ft. (15.2 m), 480 V	1-2240	PAK 200i - 90° Torch, 25 ft. (7.6 m), 480 V	1-2241	
PAK 200i - 70° Torch, 25 ft. (7.6 m), 400 V	1-2245	PAK 200i - 70° Torch, 50 ft. (15.2 m), 400 V	1-2246	PAK 200i - 90° Torch, 25 ft. (7.6 m), 400 V	1-2247	
PAK 200i - 90° Torch, 50 ft. (15.2 m), 480 V	1-2242	PAK 200i - 90° Torch, 50 ft. (15.2 m), 400 V	1-2248	PAK 200i - 180° Torch, 25 ft. (7.6 m), 480 V	1-2243	
PAK 200i - 180° Torch, 25 ft. (7.6 m), 400 V	1-2249	PAK 200i - 180° Torch, 50 ft. (15.2 m), 480 V	1-2244	PAK 200i - 180° Torch, 50 ft. (15.2 m), 400 V	1-2250	

## 1TORCH® SL60

Light/Medium Duty Torch (20 – 80 A)



- As a replacement (RPT®) torch, the 1Torch® has the ability to work on the majority of plasma power supplies on the market today
- Its unique design allows the 1Torch the ability to work with high frequency, touch, CD, and moving parts (blow back) start systems

### Ordering Information

SL60, 75, 20 ft. (6.1 m) Standard RPT Connect	7-5200	SL60, 90, 20 ft. (6.1 m) Standard RPT Connect	7-5261
SL60, 75, 50 ft. (15.2 m) Standard RPT Connect	7-5201	SL60, 90, 50 ft. (15.2 m) Standard RPT Connect	7-5262
SL60, 75, 20 ft. (6.1 m) ATC Connect	7-5204	SL60, 90, 20 ft. (6.1 m) ATC Connect	7-5260
SL60, 75, 50 ft. (15.2 m) ATC Connect	7-5205	SL60, 90, 50 ft. (15.2 m) ATC Connect (lead extension 7-7545 required)	7-5260
SL60QD Torch and Lead 20 ft. (6.1 m) 75° Head	7-5620	SL60QD Torch and Lead 50 ft. (15.2 m) 75° Head	7-5650

## 1TORCH® SL100

Medium/Heavy Duty Torch (20 – 120 A)



- Hand torches offer ergonomic handles with easy-to-use trigger release that provides comfort during prolonged use
- 75° and 90° heads offer operators a choice of positions

### Ordering Information

SL100, 75°, 20 ft. (6.1 m) Standard RPT Connect	7-5202	SL100, 90°, 20 ft. (6.1 m) Standard RPT Connect	7-5264
SL100, 75°, 50 ft. (15.2 m) Standard RPT Connect	7-5203	SL100, 90°, 50 ft. (15.2 m) Standard RPT Connect	7-5265
SL100, 75°, 20 ft. (6.1 m) ATC Connect	7-5206	SL100, 90°, 20 ft. (6.1 m) ATC Connect	7-5263
SL100, 75°, 50 ft. (15.2 m) ATC Connect	7-5208	SL100, 90°, 50 ft. (15.2 m) ATC Connect (lead extension 7-7545 required)	7-5263

## 1TORCH® Mechanized SL100, Automation SL100SV

Medium/Heavy Duty Torch (20 – 120 A)



SL100 Mechanized



SL100SV Automated

- Only 34 consumable parts cover the full range of cutting and gouging up to 120 A
- Stocking parts for a fleet of plasma units can be simplified using the 1Torch®

### Ordering Information

SL100 Mechanized, 180°, 25 ft. (7.6 m), Standard	7-5209	SL100 Mechanized, 180°, 50 ft. (15.2 m), Standard	7-5210
SL100 Mechanized, 180°, 25 ft. (7.6 m), Shielded	7-5211	SL100 Mechanized, 180°, 50 ft. (15.2 m), Shielded	7-5212
SL100 Mechanized, 180°, 5 ft. (1.5 m), Standard ATC Connect	7-5213	SL100 Mechanized, 180°, 10 ft. (3.0 m), Standard ATC Connect	7-5214
SL100 Mechanized, 180°, 25 ft. (7.6 m), Standard ATC Connect	7-5215	SL100 Mechanized, 180°, 50 ft. (15.2 m), Standard ATC Connect	7-5216
SL100 Mechanized, 180°, 5 ft. (1.5 m), Shielded ATC Connect	7-5219	SL100 Mechanized, 180°, 10 ft. (3.0 m), Shielded ATC Connect	7-5220
SL100 Mechanized, 180°, 25 ft. (7.6 m), Shielded ATC Connect	7-5221	SL100 Mechanized, 180°, 50 ft. (15.2 m), Shielded ATC Connect	7-5222
SL100SV Automated, 180°, 25 ft. (7.6 m), Standard ATC Connect	7-4001	SL100SV Automated, 180°, 35 ft. (10.6 m), Standard ATC Connect	7-4002
SL100SV Automated, 180°, 50 ft. (15.2 m), Standard ATC Connect	7-4003	SL100SV Automated, 180°, 75 ft. (22.8 m), Standard ATC Connect	7-4004
SL100SV Automated, 180°, 100 ft. (30.4 m), Standard ATC Connect	7-4005		

# 1TORCH® Consumables

## SL60 Consumables

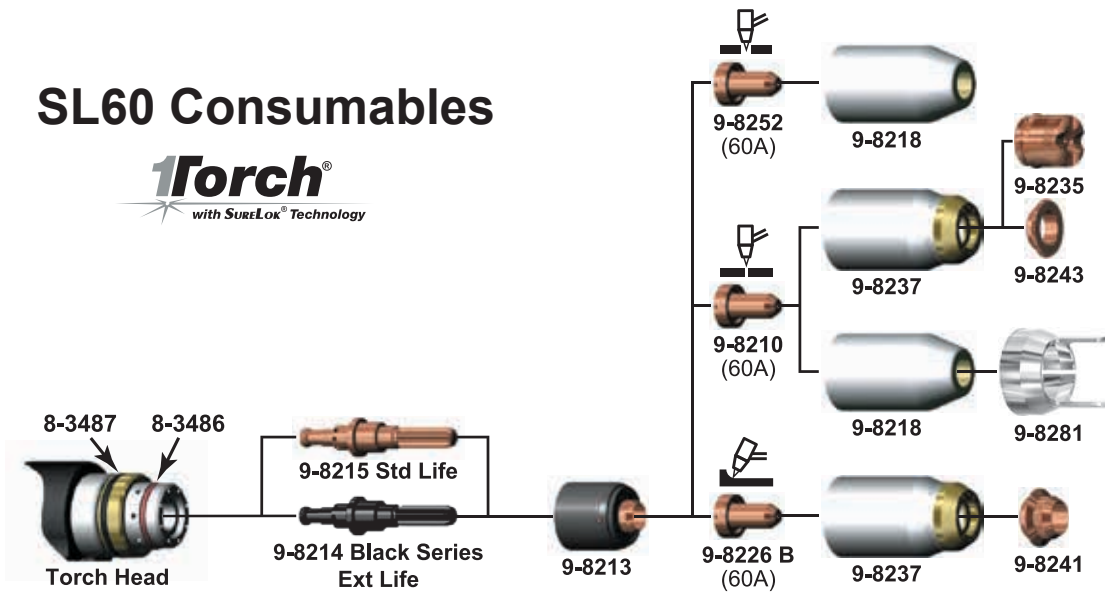

Description	Part Number	
O-Ring	8-3487	
O-Ring	8-3486	
O-Ring Lubricant	8-4025	
Black Series Electrode	9-8214	
Electrode	9-8215	
Start Cartridge	9-8213	
Heavy Duty Start Cartridge (non HF systems only)	9-8277	
Drag	Tip, 20A, Drag	9-8205
	Tip, 30A, Drag	9-8206
	Tip, 40A, Drag	9-8207
	Tip, 60A, Drag	9-8252
Standoff	Tip, 40A, Standoff	9-8208
	Tip, 50/55A, Standoff	9-8209
	Tip, 60A, Standoff	9-8210
	Tip, 70A, Standoff	9-8231
	Tip, 80A, Standoff	9-8211
	Tip, 90/100A, Standoff	9-8212
Gouge	Tip, 120A, Standoff	9-8253
	Tip, A, Gouging	9-8225
	Tip, B, Gouging	9-8226
	Tip, C, Gouging	9-8227
	Tip, D, Gouging	9-8228
Shield Cup	9-8218	
Shield Cup Body, MaximumLife®	9-8237	

Description	Part Number	
Drag	Shield Cap, Drag, 40A	9-8244
	Shield Cap, Drag, 50-60A	9-8235
	Shield Cap, Drag, 70-100A	9-8236
	Shield Cap, Drag, 120A	9-8258
Mechanized	Shield Cap, Mechanized, 40A	9-8245
	Shield Cap, Mechanized, 50-60A	9-8238
	Shield Cap, Mechanized, 70-100A	9-8239
	Shield Cap, Mechanized, 120A	9-8256
Shield Cap, Deflector	9-8243	
Shield Cap, Gouging	9-8241	
Ohmic Clip	9-8224	
Ohmic clip for manual torches	9-8259	
Spare Parts Kit, 30A	5-2550	
Spare Parts Kit, 40A	5-2551	
Spare Parts Kit, 50/55A	5-2552	
Spare Parts Kit, 60A	5-2553	
Spare Parts Kit, 70A	5-2554	
Spare Parts Kit, 80A	5-2555	
Spare Parts Kit, 90/100A	5-2556	

Note: All Spare Parts Kits above include ten (10) tips, five (5) electrodes and one (1) start cartridge.

PLASMA TORCHES

## 1TORCH® Consumables Parts Application Guide

For SL60®/SL100® Manual Cutting and Gouging Operations.



**DRAG TIP CUTTING** The preferred method of cutting light gauge metal up to 1/4 in. (6 mm) thickness. Produces the best cut quality narrowest kerf width, fastest cutting speeds, and with little to no distortion. Traditional drag cutting was limited to 40 Amps or less; now with Thermal Dynamics TRUE Cut Drag Tip Series™ technology, it is possible to cut up to 60 Amps. For best results, use the Shield Cup with the torch tip in direct contact with the work (up to 60 Amps).



**DRAG SHIELD CUTTING** This is an operator-friendly method of cutting between 70 to 120 Amps while maintaining a constant standoff distance. For metal thickness greater than 1/4 in. (6 mm), simply drag the shield cap in contact with the work piece. Use the shield cup body with the appropriate drag shield cap matching the current level being used. This method is not recommended for cutting light-gauge sheet metal.



**STANDOFF CUTTING** The preferred method of cutting metal thicker than 1/4 in. (6 mm) and at current levels above 60 Amps. Provides maximum visibility and accessibility. Shield cup for 'standoff' cutting (with the torch tip 1/8 in. (3 mm) to 1/4 in. (6 mm) from the work piece). Use the shield cup body together with the deflector for extended parts life and improved resistance to reflect heat. This combination provides cutting results similar to the single piece shield cup, as well as easy changeover to gouging or drag shield cutting.



**GOUGING** A simple method of metal removal by angling the torch to a lead angle of 35°-45°, and using a gouging tip. While maintaining a constant standoff distance, this allows for only a partial penetration into the work, thus removing metal from the surface. The amount of current, travel speed, standoff distance, lead angle, and tip size will determine the amount of material removed and the profile of the gouge. You can use the shield cup body with either the gouging shield cap or the shield deflector. Also, you can use the single piece shield cup.

Gouging Profiles			
	Output Range	Depth	Width
	40A (MAX)	Shallow	Narrow
	50-100A	Deep	Narrow
	60-120A	Moderate	Moderate
	60-120A	Shallow	Wide

## Plasma Accessories



### Cutting Guide Cutting Kit (Deluxe)

Part Number: 7-8910

Cuts circles from 2-1/8 in. (54 mm) to 41-1/2 in. (1054 mm) with proper cutting attachments. Includes easy add-on attachments to fit most Thermal Dynamics torches for precise straight line, circle cutting and beveling. Carrying case, radius/roller kit (7-7501), circle cutting guide (7-3291), magnetic pivot, suction pivot included.



### Circle Guide Cutting Kit

Part Number: 7-3291

Cuts 2-1/8 in. (54 mm) to 27-3/4 in. (705 mm) circles (using magnetic attachment) when cutting or beveling is required. For use with most Thermal Dynamics torches.



### Radius/Roller Cutting Guide Kit

Part Number: 7-7501

This easy-to-use guide cuts circles from 3 in. (76 mm) up to 28-3/4 in. (730 mm). Maintains a consistent height off the work piece whether you are using the circle cutting attachment for cutting circles or the roller guide feature to improve your straight-line cutting. Both novices and experts will see noticeable improvement in quality, speed, and parts life. Cutting Bushing (7-2915) for use with the SL40 torch.



### Straight Line Cutting Guide

Part Number: 7-8911

This versatile, straight line cutter is for hand held systems and it cuts vertical, 90° or bevel cuts. Magnetic mounts ensure placement and ease of use. Optional suction plates available for non-magnetic applications (i.e. aluminum and stainless steel). Includes: 4 ft. (1.2 m) standard rail torch holder and bushing heavy duty magnets (2 ea.) slide assembly wheels and fasteners. optional 4 ft. (1.2 m) extensions (9-7971) available.



### Standoff Cutting Guides

Part Number: 9-0090 (SL40 Torch)  
Part Number: 9-8251 (SL60/SL100 Torch, 40A)  
Part Number: 9-8281 (SL60/SL100 Torch, 60-100A)

Available for SL40 torch, SL60 and SL100 torches.



### Cutting Guide Bushing

Part Number: 7-2915

Designed to fit the SL40 torch specific to the Cutmaster 42 system. This bushing accommodates the use of the SL40 torch with the cutting guides.



### Leather Lead Covers

Part Number: 9-1258 [15 ft. (4.6 m)]  
Part Number: 9-1260 [20 ft. (6.1 m)]  
Part Number: 9-1270 [25 ft. (7.6 m)]  
Part Number: 9-1280 [50 ft. (15.2 m)]

These lead covers are suitable for both 1Torch and SureLok leads. Snaps make it easy to install. For wider torches, consider snapping two covers together width wise.



### Remote Pendant Control

Part Number: 7-3460

20 ft. (6.1 m) Remote Pendant Control for your mechanized application.



### ATC Lead Extensions

Part Number: 7-7544 [15 ft. (4.6 m)]  
Part Number: 7-7545 [25 ft. (7.6 m)]  
Part Number: 7-7552 [50 ft. (15.2 m)]

Available for any system using hand or mechanized 1Torch with ATC Quick Disconnect. Leads Extensions enable you to customize your lead length to suit the cutting job.

## Plasma Accessories

 <p><b>Single Stage Air Filter Kit</b> Part Number: 7-7507</p> <p>(Filter Body 9-7740, Hose 9-7742, Filter Element 9-7741). For use with shop compressed air systems, this in-line filter will not allow moisture or water to pass through the filter element even if it becomes completely saturated. This hi-tech filter element actually blocks the absorption of water to increase performance and improve consumable parts life.</p>	 <p><b>Two Stage Air Filter</b> Part Number: 9-9387</p> <p>First Stage Element 9-1021, Second Stage Element 9-1022). The Two Stage Air Filter will remove moisture and contaminants from the air stream when using compressed air. The filter is capable of filtering to at least 5 microns. The filter assembly is pre-assembled and need only be installed on the power supply.</p>	 <p><b>Multi-Purpose Cart</b> Part Number: 7-8888</p> <p>Designed for most portable manual cutting systems or any similar sized systems. This rugged steel cart has easy rolling 8 in. (203 mm) diameter wheels along with 3" (76 mm) front mounted casters. This cart also serves as an excellent showroom display stand.</p>
 <p><b>Cutmaster MechPak Kit</b> Part Number: 7-7725 [25 ft. (7.6 m)] Part Number: 7-7750 [50 ft. (15.2m)]</p> <p>For easy integration into semi-automatic cutting processes.</p>	<p><b>Trigger Guard Guides</b> Part Number: 9-8420</p> <p>1 Torch (SL60 and SL100). These guards offer additional protection from accidental activation or damage to the torch switch.</p>	<p><b>CNC Harness Cable</b> Part Number: 9-9385</p> <p>Assembly of electrical cables or wires which transmit signals or electrical power.</p>
	<p><b>Hand Pendant Extension</b> Part Number: 7-7744</p> <p>25 ft. (7.6 m).</p>	<p><b>Automation Interface Kit</b> Part Number: 9-8311</p> <p>For Cutmaster TRUE Series (52, 82, 102, 152). This kit adds a divided low volt output for height controls that can use 50:1 arc voltage. Required for the Thermal Dynamics SC-11 height control.</p>
	<p><b>CNC Interface Cable</b> Part Number: 9-1008 [25 ft. (7.6 m)] Part Number: 9-1010 [35 ft. (10.6 m)] Part Number: 9-1011 [50 ft. (15.2 m)]</p> <p>For "Start/Stop" and "OK to Move" Only.</p>	<p><b>Pinion Assembly</b> Part Number: 7-2827</p> <p>1-3/8 in. (35 mm) Diameter</p>

# // WELDING HELMETS









# LEVEL UP.

Up your welding game with our best Sentinel yet.

**SENTINEL**<sup>TM</sup> A60

# CONTENTS

## WELDING HELMETS

- Sentinel™ A60 .....227
- Savage™ A40 .....228
- Swarm A30 Welding Helmet .....229
- Swarm A20 Welding Helmet .....230
- Swarm™ A10 Welding Helmet .....231
- P-10 Passive Shade 10 Helmet .....232
- Savage A40 PAPR .....233

## Sentinel™ A60

Professional Shade 3/5-13 Auto-Darkening Welding Helmet



- ADF viewing area: 118 x 71 mm (4.65 x 2.8 in.) and intuitive internal ADF controls including sensitivity and delay
- Shade range: DIN 3/5–13, adjustable in 0.5 increments and ADF a shade lock setting
- ESAB OpTCS True Color Lens Technology
- On-board memory for up to 9 settings
- Arc sensors: 4
- Fast switching time of 0.08 millisecond
- Replaceable CR2450 battery
- Low battery, grind mode and shade lock LEDs

Visit [esab.com](http://esab.com) for more information.

### Specifications

Viewing Area	118 x 71 mm (4.65 x 2.8 in.)
Active Lens Shade	5–13 (Adjustable in 0.5 shade increments)
Passive Lens Shade	3
Power Supply	2 CR2450 batteries, replaceable
Arc Sensors	4
Switch Time (Light to Dark)	1/25,000 s
Switch Time (Dark to Light)	Digitally adjustable from 0.1 to 0.9 s
CE Optical Classification	1/1/1/1
Standards and Certifications	CE: EN175; EN379; EN166   ANSI: Z87.1   CSA: Z94.3   AS/NZS 1338.1   ISO 16321 +TIG
Weight	644 g (1.4 lbs)

### Ordering Information

Sentinel A60 Helmet	0700600860
---------------------	------------

Delivery includes: Full helmet assembly, 2 replacement inner lenses, 4 replacement outer lenses, carry bag, durag and safety manual.

### Wear and Spare Parts & Accessories

1	Sentinel A60 Front Cover Lens – Clear	0700600880
1	Sentinel A60 Front Cover Lens – Amber	0700600881
1	Sentinel A60 Front Cover Lens - Clear HC*	0700600882
1	Sentinel A60 Front Cover Lens – Amber HC*	0700600883
2	Sentinel A60 Helmet Shell	0700600863
4	Sentinel A60 Auto Darkening Filter ADF (excl. batteries)	0700600865
5	Sentinel A60 Inside Cover Lens	0700600866
7	Sentinel A60 Halo Headgear	0700600867
	Sentinel A60 Front Sweat band	0700600869
	Sentinel A60 Magnifying Lens +1.0 diopter **	0700600872
	Sentinel A60 Magnifying Lens +1.5 diopter **	0700600873
	Sentinel A60 Magnifying Lens +2.0 diopter **	0700600874
	Sentinel A60 Magnifying Lens +2.5 diopter **	0700600875

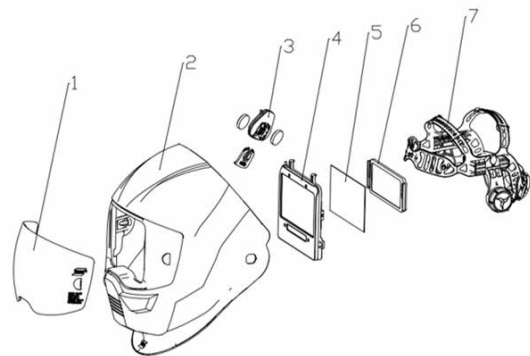

\* HC Lenses include an anti-scratch hard coat for longer life.

\*\* Magnifying Lenses are optional accessories not included with the complete helmet. The magnifier bracket is included with these lenses.

# Savage™ A40

## Professional Auto-Darkening Welding Helmet



- External shade adjustment between DIN 9 and DIN 13 and an optical class of 1/1/1/2. Delay and sensitivity can be adjusted from the inside
- Four arc sensors for higher auto darkening response
- Wider coverage and a larger viewing area of 100 x 50 mm (3.93 x 1.96 in.) that offers a wide field of vision and increased spatial awareness
- Sensitivity control is an adaptable feature useful when welding low amp TIG for better reaction to darker arc light
- Delay control enabling the welder to set how long the lens stays dark after the welding arc stops. Short delay helps get the job done faster during tack welding, whilst longer delay is useful for high amperage welding
- Externally activated Grind Button. Shade 4 Grind Mode
- True Color allowing for a brighter view and enhanced color definition

Visit [esab.com](http://esab.com) for more information.

WELDING HELMETS

Specifications	
Cartridge Dimensions	110 x 90 x 7.8 mm (4.33 x 3.54 x 0.3 in.)
Viewing Area	100 x 50 mm (3.93 x 1.96 in.)
Lens Shade	DIN 4, 9-13 Automatic
Power Supply	Solar cell, replaceable battery (1*CR2450 lithium). Alerts when low battery.
Arc Sensors	4
Switch Time, from Dark to Light	0.1-0.9 s
Switch Time Light to Dark at 23°C	0.07 ms
CE Optical Classification	1/1/1/2
Standards and Certifications	CE: EN175; EN379; EN166   ANSI: Z87.1   CSA: Z94.3
Weight	500 g (1.1 lbs)

Ordering Information	
Savage A40 Helmet (Black)	0700000490
Savage A40 Helmet (Yellow)	0700000491

Delivery includes: Full helmet assembly, safety manual.

Wear and Spare Parts & Accessories		
1	Head Gear	0700000483
2	Sweat Band	0700000414
3	Front Cover Lens	0700000010
4	Inside Cover Lens	0700000482
5	ADF Cradle	0700000418
6	Lens Retainer with Screw	0700000419
	Magnifying Lens +1.0 Diopter	0700000084
	Magnifying Lens +1.5 Diopter	0700000085
	Magnifying Lens +2.0 Diopter	0700000086
	Magnifying Lens +2.5 Diopter	0700000087

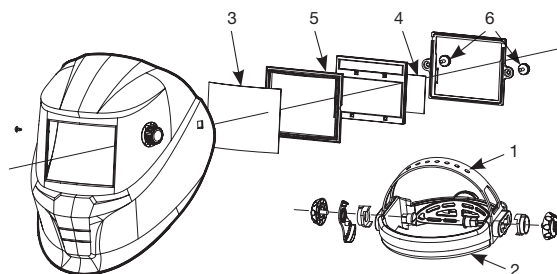

## Swarm™ A30

Auto-Darkening Welding Helmet

WELDING  
HELMETS



- ADF viewing area: 98 x 43 mm (3.85 x 1.7 in.)
- Shade range: DIN 4/9–13
- Grind mode via internal switch
- CE Optical class: 1/1/1/2
- Arc sensors: 4
- Fast switching time of 0.08 millisecond
- Internally-mounted and fully-adjustable delay and sensitivity settings
- Replaceable 1 x CR2450 battery
- Low battery indicator LED
- ADF test button

Visit [esab.com](http://esab.com) for more information.

### Specifications

Viewing Area	98 x 43 mm (3.85 x 1.7 in.)
Active Lens Shade	9-13 (Adjustable)
Passive Lens Shade	4
Power Supply	1 CR2032 battery, replaceable
Arc Sensors	2
Switch Time (Light to Dark)	0.08 ms
CE Optical Classification	1/1/1/2
Standards and Certifications	CE: EN175; EN379; EN166   ANSI: Z87.1   CSA: Z94.3
Weight	520g (1.1 lbs)

### Ordering Information

Swarm A30 Helmet	0700102044
------------------	------------

Delivery includes: Full helmet assembly, Safety Manual.

### Wear and Spare Parts

1	Swarm A10 / A20 / A30 Front Cover Lens 5 PCS	0700102036
2	Swarm A30 Inner Cover Lens 5 PCS	0700102046
3	Swarm A30 Headgear	0700102050

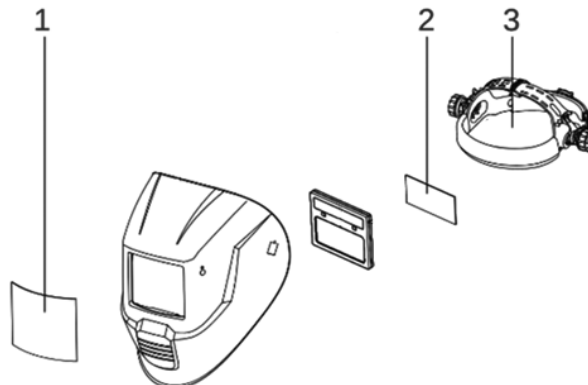

# Swarm™ A20

## Auto-Darkening Welding Helmet



- ADF viewing area: 93 x 43 mm (3.6 x 1.7 in.)
- Shade range: DIN 9–13 (adjustable)
- CE Optical class: 1/1/1/2
- Arc sensors: 2
- Fast switching time of 0.1 millisecond
- Fully-adjustable delay and sensitivity settings
- Replaceable CR2032 batteries (1)
- Low battery indicator LED
- ADF test button

Visit [esab.com](http://esab.com) for more information.

Specifications	
Viewing Area	93 x 43 mm (3.6 x 1.7 in.)
Active Lens Shade	9-13 (Adjustable)
Passive Lens Shade	4
Power Supply	1 CR2032 battery, replaceable
Arc Sensors	2
Switch Time (Light to Dark)	0.1 ms
CE Optical Classification	1/1/1/2
Standards and Certifications	CE: EN175; EN379; EN166   ANSI: Z87.1   CSA: Z94.3   Brazil CA
Weight	520g (1.1 lbs)

Ordering Information	
Swarm A20 Helmet	0700102043

Delivery includes: Full helmet assembly, safety manual.

Wear and Spare Parts		
1	Swarm A10 / A20 / A30 Front Cover Lens 5 PCS	0700102036
2	Swarm A10 / A20 Inner Cover Lens 5 PCS	0700102038
3	Swarm A10 / A20 Headgear	0700102037

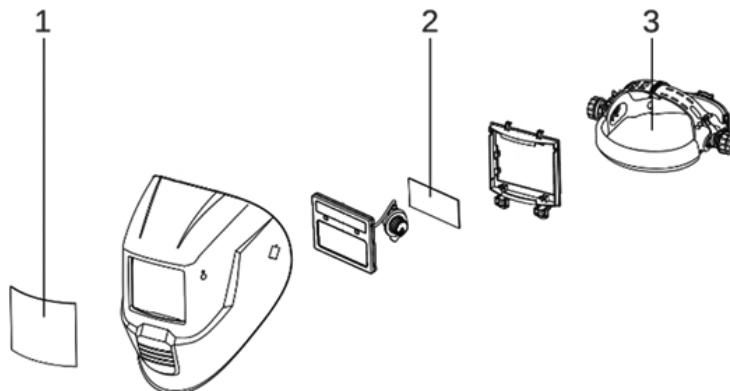

## Swarm™ A10

Auto-Darkening Welding Helmet

WELDING HELMETS



- ADF viewing area: 92 x 42mm (3.6 x 1.65 in.)
- Active lens shade: DIN 11 (fixed)
- CE Optical class: 1/1/1/2
- Arc sensors: 2
- Fast switching time of 0.1 millisecond
- 2-position adjustable delay and 3-position adjustable sensitivity
- Replaceable CR2032 batteries (2)
- Low battery indicator LED

Visit [esab.com](http://esab.com) for more information.

### Specifications

Viewing Area	92 x 42 mm (3.6 x 1.65 in.)
Active Lens Shade	11 (fixed)
Passive Lens Shade	3
Power Supply	2 CR2032 batteries, replaceable
Arc Sensors	2
Switch Time (Light to Dark)	0.1 ms
CE Optical Classification	1/1/1/2
Standards and Certifications	CE: EN175; EN379; EN166   ANSI: Z87.1   CSA: Z94.3   Brazil CA
Weight	480g (1.05 lbs)

### Ordering Information

Swarm A10 Helmet	0700102042
------------------	------------

Delivery includes: Full helmet assembly, safety manual.

### Wear and Spare Parts

1	Swarm A10 / A20 / A30 Front Cover Lens 5 PCS	0700102036
2	Swarm A10 / A20 Inner Cover Lens 5 PCS	0700102038
3	Swarm A10 / A20 Headgear	0700102037

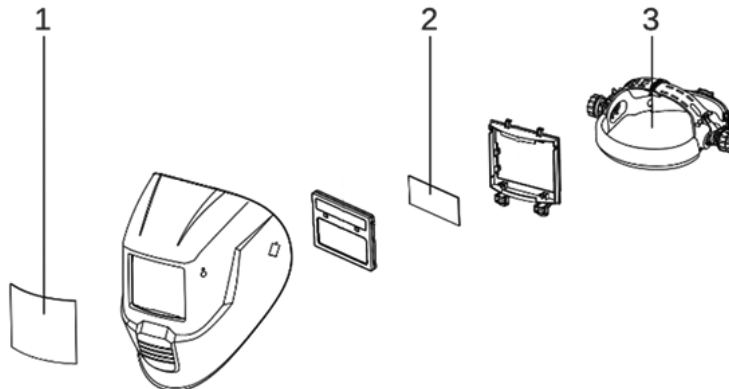



# P-10 Welding Helmet

## Passive Welding Helmet



- Large viewing area: 133 x 114 mm (5.25 x 4.5 in.)
- Filter thickness: 3mm (0.12 in)
- Shade: DIN 10
- Easy-adjust ratcheting headgear
- Durable PP shell
- UV/IR protection: DIN 16

WELDING HELMETS

Visit [esab.com](http://esab.com) for more information.

Specifications	
Viewing Area	133 x 114 mm (5.25 x 4.5 in.)
Passive Lens Shade	DIN 10
Standards and Certifications	ANSI: Z87.1   CSA: Z94.3
Weight	490 grams (1.08 lbs)

Ordering Information	
P-10 Passive Shade 10 Welding Helmet	0700102052

Delivery includes: Ready-to-use P-10 welding helmet, safety manual.

Wear and Spare Parts		
1	P-10 replacement Shade 10 filter lens	0700102051

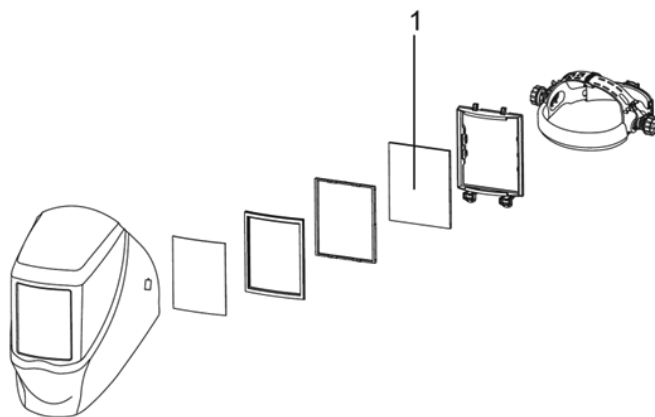

## Savage™ A40 PAPR

Professional Automatic Welding Helmet with NIOSH-Approved PAPR

WELDING HELMETS



- NIOSH-approved PAPR filtration system delivers three setting adjustable flow from 170 to 230 liters per minute
- Convenient push-button interface with easy to read LCD display for PAPR adjustment
- High efficiency 2 stage filtration system with spark arrestor for added safety
- LCD display indicating fan speed, flow rate and battery charge level with additional audible alert for low battery
- High quality shielded air tube with simple connections
- Fully adjustable PAPR harness and multi-point helmet headgear adjustment for total comfort
- Four sensor ADF with adjustable shade, sensitivity and delay controls to dial in the precise darkness and reaction speed

Visit [esab.com](http://esab.com) for more information.

### Specifications

Cartridge Dimensions	110 x 90 x 7.8 mm (4.33 x 3.54 x 0.3 in.)
Viewing Area	100 x 50 mm (3.93 x 1.96 in.)
Lens Shade	DIN 4, 9-13 Automatic
Power Supply (helmet)	Replaceable CR2450 battery with solar cell backup. Alerts when low battery.
Power Supply (PAPR)	4400mAh Li-Ion rechargeable battery (charger included). Alerts when low battery.
Sensors	4
Switch Time, from Dark to Light	0.1-0.9 s
Switch Time, at 23°C (73°F)	0.07 ms
CE Optical Classification	1/1/1/2
Standards and Certifications	NIOSH   ANSI Z87.1   CE: EN379; EN175   AS/NZS 1338.1   CSA Z94.3
Weight	1350 g (2.97 lbs)

### Ordering Information

Savage A40 Helmet (Black) with NIOSH PAPR	0700002400
---	------------

Kit includes: Full helmet assembly; PAPR blower; hose; (2) Li-Ion batteries; (5) inner lenses; (3) outer lenses; (2) P3 particulate filters; (5) prefilters; (2) spark arrestors; heavy duty carry duffel bag

### Options & Accessories

Breathing Tube 1 m (3.3 ft) w/ Cloth NIOSH-PAPR	0700002409
Magnifying Lens +1.0 Diopter	0700000084
Magnifying Lens +1.5 Diopter	0700000085
Magnifying Lens +2.0 Diopter	0700000086
Magnifying Lens +2.5 Diopter	0700000087
Filter Cover	0700002402
Pre-Filter NIOSH - PAPR (5)	0700002404
Main Filter NIOSH - PAPR	0700002403
Standard Battery NIOSH - PAPR	0700002407



**Wear and Spare Parts (PAPR System)**

1	Savage A-40 9-13 Helmet Prepared for PAPR	0700500400
2	Filter Cover NIOSH-PAPR	0700002402
3	Spark Arrestor NIOSH-PAPR	0700002405
4	Pre-Filter NIOSH-PAPR (5)	0700002404
5	Main Filter NIOSH -PAPR	0700002403
6	Blower Unit NIOSH-PAPR	0700002406
7	Waist Belt w/ Shoulder Strap NIOSH-PAPR	0700002411
8	Battery Charger NIOSH-PAPR	0700002414
9	Carrier Bag NIOSH-PAPR	0700002415
10	Standard Battery NIOSH -PAPR	0700002407
11	Breathing Tube (1M) w/ Cloth NIOSH-PAPR	0700002409
12	Portable Air Flow Tester NIOSH-PAPR	0700002413

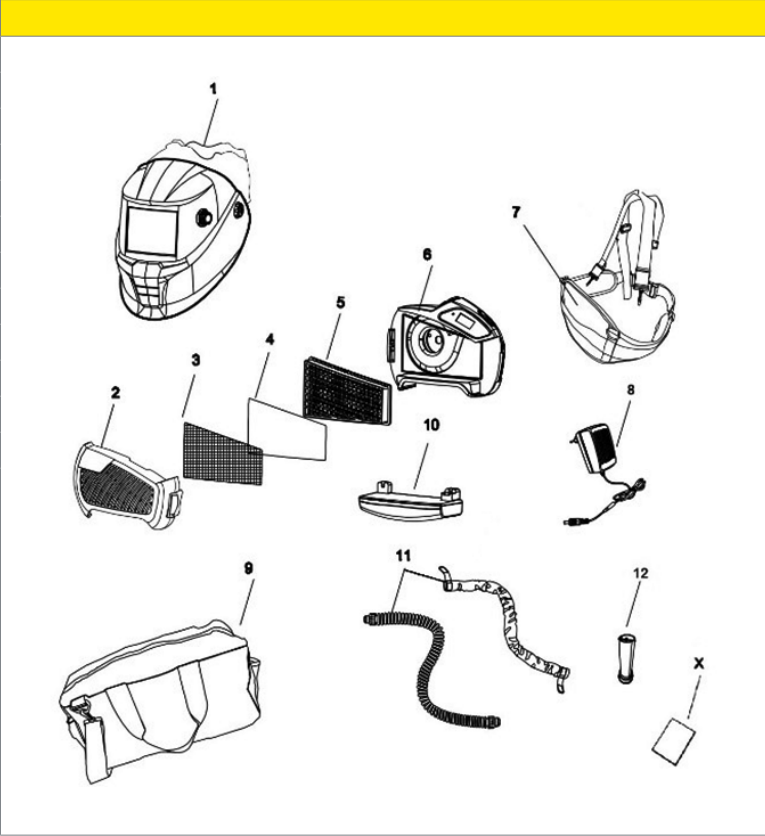

**Wear and Spare Parts (Savage ADF Helmet)**

1	Head Gear	0700000483
2	Sweat Band	0700000414
3	Front Cover Lens	0700000010
4	Inside Cover Lens	0700000482
5	ADF Cradle	0700000418
6	Lens Retainer with Screw	0700000419
7	Head Gear with Air Duct	0700500404
8	Face Seal	0700500405

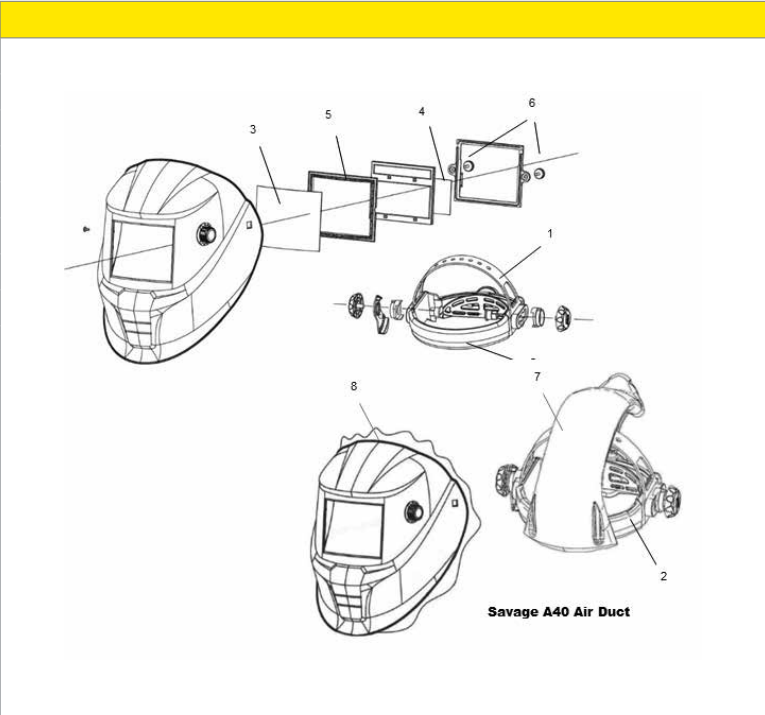

# BREATHE EASIER WITH INTEGRATED FUME MITIGATION SOLUTIONS.

ESAB makes it easier to create a healthier, less stressful work environment with integrated fume mitigation solutions that include the new Tweco **Centrovac** MIG gun, **CarryVac 2** portable fume extractor and **Savage A40 PAPR**.

## CAPTURED AT THE SOURCE

Removing welding fumes at the gun nozzle is a great way to meet OSHA and ACGIH standards. Tweco Centrovac fume extraction MIG guns limit particulates in the operator's breathing zone, and they especially help when welding in confined areas or inside tanks.

Even at high volumes and vertical up welds, Centrovac's fume extraction will not interfere with shielding gas coverage. The guns are available in air- and water-cooled models and adapt to most brands of wire feeders.



## PORTABLE EXTRACTION

For location flexibility in manganese and general fume reduction applications, pair Centrovac with the CarryVac 2 P150 portable extraction unit. CarryVac 2 runs off 115V primary power and has an automatic start/stop function to extend filter life.

## POWERED AIR PURIFYING RESPIRATORS

Savage A40 PAPR combines exceptional value and performance. Its two-stage replaceable filtration cartridge meets NIOSH certification and removes 99.9 percent of airborne particles, including fumes generated from stainless steel, chrome alloys and chrome-coated metals.



**Carryvac**  
P 150









# 100% SATISFACTION IS OUR **PROMISE TO YOU.**

**Our pledge:** To create the best products and give customers complete buying confidence with our 100% Satisfaction Guarantee and the most extensive warranties, including a new lifetime warranty on all Victor® EDGE™ Series 2.0 regulators.



Learn more at [esab.com/support/warranty](https://esab.com/support/warranty)



ESAB / [esab.com](https://esab.com)



XA00262721 / NA / EN / 01-23-23 / Note: Specifications subject to change without notice. Products may vary from those pictured.