



JASIC®

EVO2.0



Operator Manual

EM-200CT & EM-250CT



Your new product



Jasic.co.uk

Thank you for selecting this Jasic EVO 2.0 product.

This product manual has been designed to ensure that you get the most from your new product. Please ensure that you are fully conversant with the information provided paying particular attention to the safety precautions. The information will help protect yourself and others against the potential hazards that you may come across.

Please ensure that you carry out daily and periodic maintenance checks to ensure years of reliable and trouble free operation.

Please call your Jasic distributor in the unlikely event of a problem occurring. Please record below the details from your product as these will be required for warranty purposes and to ensure you get the correct information should you require assistance or spare parts.

Date purchased _____

From where _____

Serial number _____

(The serial number is normally located on the top or underside of the machine and will begin with AA)

For further information on your Jasic product warranty registration please visit:

www.jasic-warranty.co.uk

Disclaimer

Whilst every effort has been made to ensure that the information contained within this manual is complete and accurate, no liability can be accepted for any errors or omissions.

Please Note:

Products are subject to continual development and may be subject to change without notice. Regularly check our product pages at www.jasic.co.uk for revision updated operating manuals.

No part of this manual may be copied or reproduced by any means without the written permission of Wilkinson Star Limited.

CONTENTS

	Page
Your New Product	2
Index	3
Safety Instruction	4
General electrical safety	4
General operating safety	4
PPE	5
Welding processes lens shade selector guide	5
Fume and welding gases	6
Fire risks	6
The working environment	7
Protection from moving parts	7
Magnetic fields	7
Compressed gas cylinders and regulators	7
RF declaration	8
LF declaration	8
Materials and their disposal	9
Package and Contents	9
Description of Symbols	10
Product Overview	12
Technical Specifications	13
Description of Controls	14
Installation	16
Control Panel Description	19
Remote Control (wired and wireless)	28
Remote Control Socket	29
Operating MIG	30
Guide to MIG/MAG Welding	38
Spool Gun Operation	45
MIG Welding Chart	46
MIG Welding Problems	47
MIG Torch Description and Spare Parts List	49
MMA Setup	50
Operating MMA	51
Guide to MMA Welding	54
MMA Welding Troubleshooting	58
Lift TIG Setup	59
Operating Lift TIG	60
Guide to Lift TIG	62
TIG Torch Description and Spare Parts List	67
TIG Welding Troubleshooting	68
Maintenance	71
Troubleshooting	71
Troubleshooting Error Codes	72
WEEE Disposal	73
RoHS Compliance Declaration	73
UKCA Declaration of Conformity	74
EC Declaration of Conformity	75
Statement of Warranty	76
Schematic	77
Options and Accessories	78
Jasic Contact Details	80

SAFETY INSTRUCTIONS



These general safety norms cover both arc welding machines and plasma cutting machines unless otherwise noted. The user is responsible for installing and operating the equipment in accordance with the enclosed instructions.

It is important that users of this equipment protect themselves and others from harm, or even death. The equipment must only be used for the purpose it was designed for. Using it in any other way could result in damage or injury and in breach of the safety rules.

Only suitably trained and competent persons should operate the equipment.

Pacemaker wearers should consult their doctor prior to using this equipment.

PPE and workplace safety equipment must be compatible for the application of the work involved.

Always carry out a risk assessment before carrying out any welding or cutting activity.

General electrical safety



Danger
Electric shock risk

The equipment should be installed by a qualified person and in accordance with current standards in operation.

It is the users responsibility to ensure that the equipment is connected to a suitable power supply. Consult your utility supplier if required.

Do not use the equipment with the covers removed. Do not touch live electrical parts or parts which are electrically charged. Turn off all equipment when not in use.

In the case of abnormal behaviour of the equipment, the equipment should be checked by a suitably qualified service engineer.

If earth bonding of the work piece is required, bond it directly with a separate cable with a current carrying capacity capable of carrying the maximum capacity of the machine current.

Cables (both primary supply and welding) should be regularly checked for damage and overheating.

Never use worn, damaged, under sized or poorly jointed cables.

Insulate yourself from work and earth using dry insulating mats or covers big enough to prevent any physical contact.

Never touch the electrode if you are in contact with the work piece return.

Do not wrap cables over your body.

Ensure that you take additional safety precautions when you are welding in electrically hazardous conditions such as damp environments, wearing wet clothing and metal structures.

Try to avoid welding in cramped or restricted positions.

Ensure that the equipment is well maintained. Repair or replace damaged or defective parts immediately.

Carry out any regular maintenance in accordance with the manufacturers instructions.

The EMC classification of this product is class A in accordance with electromagnetic compatibility standards CISPR 11 and IEC 60974-10 and therefore the product is designed to be used in industrial environments only.

WARNING: This class A equipment is not intended for use in residential locations where the electrical power is provided by a public low-voltage supply system. In those locations it may be difficult to ensure the electromagnetic compatibility due to conducted and radiated disturbances.

General operating safety



Never carry the equipment or suspend it by the carrying strap or handles during welding.

Never pull or lift the machine by the welding torch or other cables.

Always use the correct lift points or handles. Always use the transport under gear as recommended by the manufacturer.

Never lift a machine with the gas cylinder mounted on it.

If the operating environment is classified as dangerous, only use S-marked welding equipment with a safe idle voltage level. Such environments may be for example: humid, hot or restricted accessibility spaces.

SAFETY INSTRUCTION

CAUTION Use of Personal Protective Equipment (PPE)

PPE REQUIRED AT ALL TIMES

Welding arc rays from all welding and cutting processes can produce intense, visible and invisible (ultraviolet and infrared) rays that can burn eyes and skin.

- Wear an approved welding helmet fitted with an appropriate shade of filter lens to protect your face and eyes when welding, cutting or watching.
- Wear approved safety glasses with side shields under your helmet.
- Never use any equipment that is damaged, broken or faulty.
- Always ensure there are adequate protective screens or barriers to protect others from flash, glare and sparks from the welding and cutting area.
- Ensure that there are adequate warnings that welding or cutting is taking place.
- Wear suitable protective flame resistant clothing, gloves and footwear.
- Ensure adequate extraction and ventilation is in place prior to welding and cutting to protect users and all workers nearby.
- Check and be sure the area is safe and clear of flammable material before carrying out any welding or cutting.



Some welding and cutting operations may produce noise. Wear safety ear protection to protect your hearing if the ambient noise level exceeds the local allowable limit (e.g: 85 dB).

Welding and Cutting Lens Shade Selector Guide

WELDING CURRENT	MMA ELECTRODES	MIG LIGHT ALLOY	MIG HEAVY METALS	MAG	TIG ALL METALS	PLASMA CUTTING	PLASMA WELDING	GOUGING ARC/AIR
10	8	10	10	10	9	11	10	10
15								
20	11							
30					11			
40	12							
60		12						
80	13							
100		13						
125	14							
150		14						
175	15							
200		15						
225	16							
250		16						
275	17							
300		17						
350	18							
400		18						
450	19							
500		19						

SAFETY INSTRUCTION

Safety against fumes and welding gases



Warning
Fumes and
Gases

The HSE have identified welders as being an 'at risk' group for occupational diseases arising from exposure to dusts, gases, vapours and welding fumes. The main identified health effects are pneumonia, asthma, chronic obstructive pulmonary disease (COPD), lung and kidney cancer, metal fume fever (MFF) and lung function changes.

During welding and hot cutting 'hot work' operations, fumes are produced which are collectively known as welding fume. Depending upon the type of welding process being performed, the resultant fume generated is a complex and highly variable mixture of gases and particulates. Regardless of the length of welding being carried out, all welding fume, including mild steel welding requires suitable engineering controls to be in place which is usually Local Exhaust Ventilation (LEV) extraction to reduce the exposure to welding fume indoors and where LEV does not adequately control exposure it should also be enhanced by using suitable respiratory protective equipment (RPE) to assist with protecting against residual fume.

When welding outdoors appropriate RPE should be used.

Prior to undertaking any welding tasks an appropriate risk assessment should be carried out to ensure expected control measures are in place.

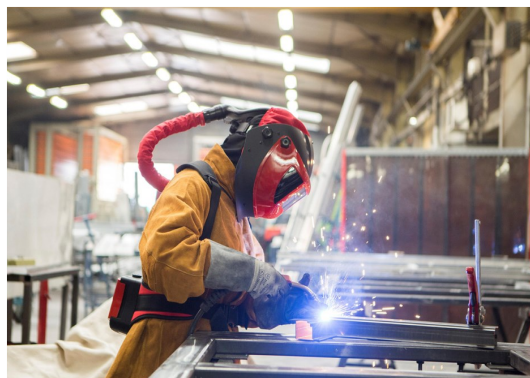

An example of personal fume protection

Locate the equipment in a well-ventilated position and keep your head out of the welding fume.

Do not breathe in the welding fume.

Ensure the welding zone is well-ventilated and provision should be made for suitable local fume extraction system to be in place.

If ventilation is poor, wear an approved airfed welding helmet or respirator.

Read and understand the Material Safety Data Sheets (MSDS's) and the manufacturer's instructions for metals, consumable, coatings, cleaners and de-greasers.

Do not weld in locations near any de-greasing, cleaning or spraying operations.

Be aware that heat and rays of the arc can react with vapours to form highly toxic and irritating gases.

For further information please refer to the HSE website www.hse.gov.uk for related documentation.

Precautions against fire and explosion



Caution
Risk of fire

Avoid causing fires due to sparks and hot waste or molten metal.

Ensure that appropriate fire safety devices are available near the welding and cutting area.

Remove all flammable and combustible materials from the welding, cutting and surrounding areas.

Do not weld or cut fuel and lubricant containers, even if empty. These must be carefully

cleaned before they can be welded or cut.

Always allow the welded or cut material to cool before touching it or

placing it in contact with combustible or flammable material.

Do not work in atmospheres with high concentrations of combustible fumes, flammable gases and dust.

Always check the work area half an hour after cutting to make sure that no fires have begun.

Take care to avoid accidental contact of the torch electrode to metal objects, as this could cause arcs, explosion, overheating or fire.

Know and understand your fire extinguishers

	Water	Foam spray	ABC powder	Carbon dioxide	Wet chemical
<i>Symbols found on fire extinguishers & what they mean</i>					
Flammable Wood, paper & textiles	✓	✓	✓	✗	✓
Flammable liquids	✗	✓	✓	✓	✗
Flammable gases	✗	✗	✓	✗	✗
Electrical contact	✗	✗	✓	✓	✗
Cooling oil & fats	✗	✗	✗	✗	✓

SAFETY INSTRUCTION

The working environment



Ensure the machine is mounted in a safe and stable position allowing for cooling air circulation.
Do not operate equipment in an environment outside the laid down operating parameters.
The welding power source is not suitable for use in rain or snow.

Always store the machine in a clean, dry space.

Ensure the equipment is kept clean from dust build up.

Always use the machine in an upright position.

Protection from moving parts



When the machine is in operation keep away from moving parts such as motors and fans.

Moving parts, such as the fan, may cut fingers and hands and snag garments.

Protections and coverings may be removed for maintenance and managed only by qualified personnel after first disconnecting the power supply cable.

Replace the coverings and protections and close all doors when the intervention is finished and before starting the equipment.

Take care to avoid getting fingers trapped when loading and feeding wire during set up and operation.

When feeding wire be careful to avoid pointing it at other people or towards your body.

Always ensure machine covers and protective devices are in operation.

Risks due to magnetic fields



The magnetic fields created by high currents may affect the operation of pacemakers or electronically controlled medical equipment.

Wearers of vital electronic equipment should consult their physician before beginning any arc welding, cutting, gouging or spot welding operations.

Warning
Strong magnetic field

Do not go near welding equipment with any sensitive electronic equipment as the magnetic fields may cause damage.

Keep the torch cable and work return cable as close to each other as possible throughout their length.

This can help minimise your exposure to harmful magnetic fields.

Do not wrap the cables around the body.

Handling of compressed gas cylinders and regulators



Mishandling gas cylinders can lead to rupture and the release of high pressure gas.

Always check the gas cylinder is the correct type for the welding to be carried out.

Always store and use cylinders in an upright and secure position.

Danger
Compressed gas

All cylinders and pressure regulators used in welding operations should be handled with care.

Never allow the electrode, electrode holder or any other electrically “hot” parts to touch a cylinder.

Keep your head and face away from the cylinder valve outlet when opening the cylinder valve.

Always secure the cylinder safely and never move with regulator and hoses connected.

Use a suitable trolley for moving cylinders.

Regularly check all connections and joints for leaks.

Full and empty cylinders should be stored separately.

Never deface or alter any cylinder

SAFETY INSTRUCTIONS

Fire awareness



The cutting and welding process can cause serious risks of fire or explosion. Cutting or welding sealed containers, tanks, drums or pipes can cause explosions. Sparks from the welding or cutting process can cause fires and burns. Check and risk assess the area is safe before doing any cutting or welding. Ventilate all flammable or explosive vapour from the workplace.

Remove any and all flammable materials away from the working area. If necessary, cover flammable materials or containers with approved covers (following manufacturers instructions) if unable to remove from the immediate area.

Do not cut or weld where the atmosphere may contain flammable dust, gas or liquid vapour. Always have the appropriate fire extinguisher nearby and know how to use it.

Hot parts



Always be aware that material being cut or welded will get very hot and hold that heat for a considerably long time which will cause severe burns if the appropriate PPE is not worn. Do not touch hot material or parts with bare hands.

Always allow for a cooling down period before working on material recently cut or welded. Use the appropriate insulated welding gloves and clothing to handle hot parts to prevent burns.

Noise awareness



The cutting and welding process can generate noise that can cause permanent damage to your hearing. Noise from cutting and welding equipment can damage hearing.

Always protect your ears from noise and wear approved and appropriate ear protection if noise levels are high.

Consult with your local specialist if you are unsure how to test for noise levels.

RF Declaration



Equipment that complies with directive 2014/30/EU concerning electromagnetic compatibility (EMC) and the technical requirements of EN60974-10 is designed for use in industrial buildings and not for domestic use where electricity is provided via the low voltage public distribution system.

Difficulties may arise in assuring class A electromagnetic compatibility for systems installed in domestic locations due to conducted and radiated emissions.

In the case of electromagnetic problems, it is the responsibility of the user to resolve the situation.

It may be necessary to shield the equipment and fit suitable filters on the mains supply.

LF Declaration



Consult the data plate on the equipment for the power supply requirements.

Due to the elevated absorbance of the primary current from the power supply network, high power systems affect the quality of power provided by the network. Consequently, connection restrictions or maximum impedance requirements permitted by the network at the public network connection point must be applied to these systems.

In this case, the installer or the user is responsible for ensuring the equipment can be connected, consulting the electricity provider if necessary.

SAFETY INSTRUCTION

Materials and their disposal



Welding equipment is manufactured with BSI published standards meeting CE requirements for materials which do not contain any toxic or poisonous materials dangerous to the operator. Do not dispose of the equipment with normal waste.



The European Directive 2012/19/EU on Waste Electrical and Electronic Equipment states that electrical equipment that has reached its end of life must be collected separately and returned to an environmentally compatible recycling facility for disposal.

For more detailed information please refer to the HSE website www.hse.gov.uk

PACKAGE CONTENTS AND UNPACKING

Supplied within your new Jasic EVO product package will be the following items with each model.

Use care when unpacking the contents and ensure all items are present and not damaged.

If damage is noted or items are missing, please contact the supplier in the first instance and before installing or using the product.

Record the product model, serial numbers and purchase date in the information section found on the inside front page of this operating manual.

Jasic EVO MIG 200 PFC

- EM-200CT PFC Power Source
- MIG Torch
- MMA work lead
- Work Return Lead
- USB Stick with Operating Manual

Jasic EVO MIG 250 PFC

- EM-250CT PFC Power Source
- MIG Torch
- MMA work lead
- Work Return Lead
- USB Stick with Operating Manual



Please Note: Package contents may vary depending on country location and package part number purchased

DESCRIPTION OF SYMBOLS

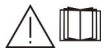

Read this operation manual carefully before use.



Warning in operation.



Single-phase static frequency converter-transformer rectifier.



1 ~ 50/60Hz

Symbol of single-phase AC power supply and rated frequency.



Can be used in the environment which has high risk of electric shock.

IP

Degree of protection, such as IP23S.

U₁

Rated AC input voltage (with tolerance $\pm 15\%$).

I_{1max}

Rated maximum input current.

I_{1eff}

Maximum effective input current.

X

Duty cycle, The ratio of given duration time/the full-cycle time.

U₀

No-load voltage, Open circuit voltage of secondary winding.

U₂

Load voltage.

H

Insulation class.



Do not dispose of electric waste with other ordinary waste.



Electric shock risk warning.



Current unit "A"



Overheat protection indicator.



Overcurrent protection indicator.



VRD function indicator.



MMA mode.



LIFT TIG mode.

ϕ 3.2

ϕ 4.0

Selection of welding electrode diameter for MMA.



MMA current.



Hot start current of MMA.



Arc force of MMA.



Welding mode switching.



Other function switching.



Wireless indication.



Remote control.











Pairing of wireless remote controller.

DESCRIPTION OF SYMBOLS



Read this operation manual carefully before use.

Steel Ar80% CO₂20%	Mixed gas welding (80% argon + 20% CO ₂) of carbon steel
Steel FluxCored Ar80% CO₂20%	Mixed gas welding (80% argon + 20% CO ₂) of flux-cored carbon steel
Steel FCW-SS	Self-shielded welding of carbon steel
AlMg Ar100%	100% argon shielding of aluminum magnesium alloy
CrNi Ar98% CO₂2%	Mixed gas welding (98% argon + 2% CO ₂) of stainless steel
	Welding type selection: welding base metal and gas
ϕ 0.6 ϕ 0.8 ϕ 1.0 ϕ 1.2	Welding wire diameter
	MIG/Lift TIG 2T operation
	MIG/Lift TIG 4T operation
	MIG torch
	MIG spool torch
	MIG synergic function
	Inching wire feeding function
	Gas check function

PRODUCT OVERVIEW

These digital EM-200CT and EM-250CT PFC MIG inverter welding machines feature advanced technology that provides excellent welding performance along with user experience. They provide a stable arc that is ideal for MIG, DC Lift TIG and MMA which can weld carbon steel, low alloy steel, stainless steel and other materials.

Moreover, they offer many adjustable MIG and MMA functions and features that makes these machine very durable and robust machines for a wide range of welding applications.

The unique electrical structure and air passage design inside the machine increases the dissipation of heat generated by power devices, thus improving the duty cycle of the machine.

Benefitting from the unique air passage, the equipment can effectively prevent damage to power devices and control circuits from dust drawn in by the fan, thus greatly improving the reliability of the equipment.

The unique ClearVision display offers the operator clear and informative data for the welding processed offered.



Features and functions that include:

- Three welding processes: Standard/Synergic MIG, MMA and DC Lift TIG.
- The EVO range offers a robust and industrial look with ergonomic design that includes Active Balancing Air Passage (ABAP).
- Inbuilt power factor correction (PFC). Where the power factor is the ratio of true power (KW) divided by reactive power (kvar). Power factor value is between 0.0 and 1.00 and if the power factor exceeds 0.8, the device is using mains input power efficiently.
- Wide Voltage mains input, this technology allows these to fully operate on mains input supplies seamlessly between 95V ~ 265V AC with auto compensation for mains voltage fluctuation.
- ClearVision digital control user panel technology.
- MIG features that include Synergic mode, dial in plate thickness, material, gas and wire size selection.
- Spool gun compatible.
- EM-200CT has a 2 roll drive system and the EM-250CT has a 4 roll drive system.
- TIG feature that include, pre/post gas timers, down slope control and 2T/4T trigger modes.
- Machine features such as, quick factory reset function, auto sleep mode and voltage reduction device (VRD).
- Fan on-demand which prolongs the life span of the internal fan which reduces the accumulation of grinding dust inside the machine.
- Overcurrent and overheat protection.
- MMA features that include, arc force, hot start current and anti-stick that offer easy arc starting, low spatter, stable current which offers good weld bead shape making this machine ideal for a wide range of electrodes.
- Parameters are automatically saved on shutdown and are restored automatically upon restarting the machine.
- Wired remote control interface as standard via front panel mounted 9 pin socket.
- Optional wireless remote control is available.
- Heavy duty 35-50mm dinse sockets.
- Generator friendly.
- High quality finish to mouldings, under carriage trolley with swivel front wheels and cylinder support.

TECHNICAL SPECIFICATIONS

Parameter	Unit	Jasic MIG EM-200CT PFC		Jasic MIG EM-250CT PFC	
Rated input (U1)	V	AC 95 ~ 265V		AC 95 ~ 265V	
Rated input Frequency	Hz	50/60		50/60	
Input Voltage	V	115V	230V	115V	230V
Rated input current (I _{eff})	A	MMA 15.5 MIG 17.4 TIG 13.3	MMA 13.6 MIG 13.5 TIG 10.6	MMA 18.1 MIG 19 TIG 15.9	MMA 17.6 MIG 18.5 TIG 14.5
Rated input current (I _{max})	A	MMA 28.3 MIG 38.1 TIG 24.2	MMA 24.8 MIG 32.8 TIG 19.3	MMA 33.0 MIG 53.2 TIG 29.1	MMA 32.2 MIG 44.9 TIG 26.5
Rated input power	kVA	MMA 3.2 MIG 3.6 TIG 2.8	MMA 5.7 MIG 5.6 TIG 4.4	MMA 3.8 MIG 4.0 TIG 3.3	MMA 6.9 MIG 7.7 TIG 6.1
Welding current range	A	MMA 20 ~ 110 MIG 30 ~ 140 TIG 5 ~ 140	MMA 20 ~ 180 MIG 30 ~ 200 TIG 5 ~ 200	MMA 20 ~ 125 MIG 30 ~ 160 TIG 5 ~ 160	MMA 20 ~ 220 MIG 30 ~ 250 TIG 5 ~ 250
MIG voltage range (U2)	V	MIG 11 ~ 23	MIG 11 ~ 28	MIG 11 ~ 25	MIG 11 ~ 30
Rated duty cycle (X) (rated at 40°C)	%	30%		30%	
Wire Feed Type	-	2 Roll Drive		4 Roll Drive	
Wire feed speed range	m/min	2 ~ 12	2 ~ 16	2 ~ 14	2 ~ 18
Suitable wire size	mm	0.6 - 0.8 - 1.0			
Arc Force Range	A	0 ~ 100			
Hot Start Range	A	0 ~ 60 (30 by default)			
No load voltage (U0)	V	68		70	
VRD voltage (MMA/TIG)	V	11			
Efficiency	%	> 80		> 80	
Idle State Power	W	< 50			
Power factor	cosφ	0.99			
Characteristic	-	CC/CV			
Standard	-	EN60974-1			
Protection class	IP	IP23S			
Insulation class	-	H			
Pollution Level	-	Grade 3			
Noise	Db	< 70			
Operating Temperature range	°C	-10 ~ +40			
Storage temperature	°C	-25 ~ +55			
Size (with handle)	mm	920 x 480 x 755 (LxWxH)			
Net weight	Kg	41.9		43.5	
Overall weight	Kg	53.4		56	

DESCRIPTION OF CONTROLS - JASIC MIG EM-200CT and EM-250CT

Front and Rear view Jasic MIG EM-200CT and EM-250CT

1. Digital user control panel (see lower down for further information)
2. "+" Output terminal*, The connection for the torch in MIG mode
3. Wireless remote control (optional)
4. Wired remote control 9 pin socket
5. MIG torch outlet, The connection used to connect the euro style MIG torch
6. "-" Output terminal*, The connection for the work return lead in MIG mode
7. Front cooling grill
8. Euro outlet trailing cable plug, this plug is used to determine the polarity of the torch euro outlet connector
9. Carriage front wheels (lockable)

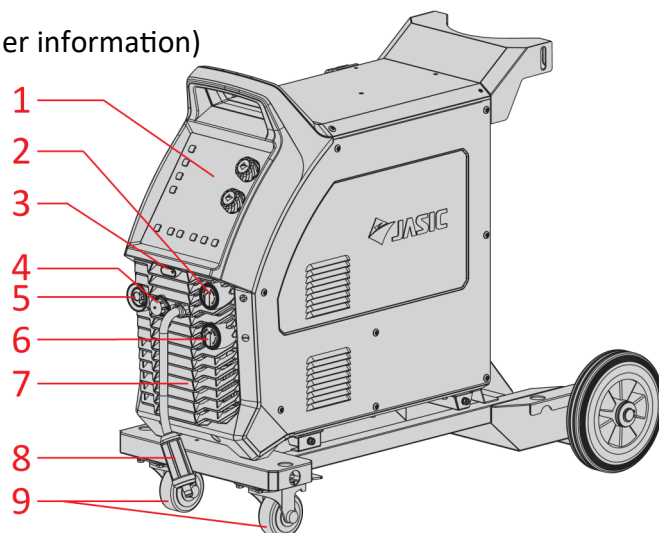

* Panel socket size is 35/50mm

Rear view Jasic MIG EM-200CT and EM-250CT

10. ON/OFF power switch
11. Shielding gas inlet hose
12. Machine mains power cable
13. Rear panel with integrated cooling vents
14. Rear support wheels

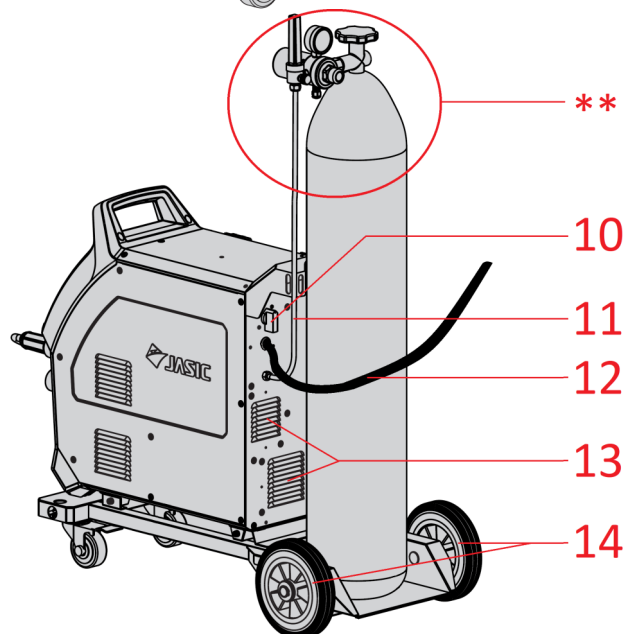

** Gas cylinder, gas regulator and gas flow meter

Front control panel view Jasic MIG EM-200CT and EM-250CT

15. Remote control enable switch and indicator
16. Synergic control ON/OFF switch and indicator
17. Wire Inch Button and indicator
18. Gas Test Button and indicator
19. Welding Mode selection area
20. MIG Parameter selection area
21. Digital display windows and controls
22. Warning indicators
23. MIG and MIG Spool Gun selection switch and indicators
24. 2T and 4T selection switch and indicator



For further information of the control panel, please see page 19

DESCRIPTION OF CONTROLS - JASIC MIG EM-200CT and EM-250CT

Side view Jasic MIG EM-200CT and EM-250CT

0. Gas cylinder support bracket
1. Wire spool holder and tensioner: Allows a 15Kg (300mm dia) reel of wire to be located in place via an alignment pin and then locked in place with the locking nut. The spool holder also has a brake arrangement to ensure correct tension of the wire, this is done by turning the central bolt with a socket clockwise (to tighten) or anti clockwise (to loosen)
2. Door retaining clips
3. Carriage cylinder support stand
4. Handle
5. Control panel
6. Internal LED light
7. Drive assembly feed motor and gearbox
8. Trailing cable that determines torch output polarity
9. Outlet feed adaptor: Part of the Euro outlet connector which contains the inner outlet guide which ensures smooth wire feed from the drive assembly through to the MIG torch
10. Foot operated front swivel wheel brake
11. Inlet wire guide: The welding wire is fed through the inlet guide prior to feeding through the drive rollers
12. Pressure roll assembly*: Holds the upper drive roll(s) in place which applies pressure to the welding wire via the installed grooved drive roll (S). The upper roll(s) are held in place via retaining circlip(s) which holds the grooved drive roll(s) in place
13. Drive roll tensioner: Allows the correct amount of tension to be applied to the top roller to ensure good feed of the wire through the MIG torch
14. Outlet feed adaptor: Part of the Euro outlet connector which contains the inner outlet guide
15. The inner outlet guide tune which ensures smooth wire feed from the drive assembly through to the MIG torch
16. Wire feed roll(s) and retaining nut which secures and holds the grooved drive roll(s) in place
17. Intermediate wire guide: Ensures the wire passes in between the 2 sets of feed rollers smoothly (EM-250CT only)

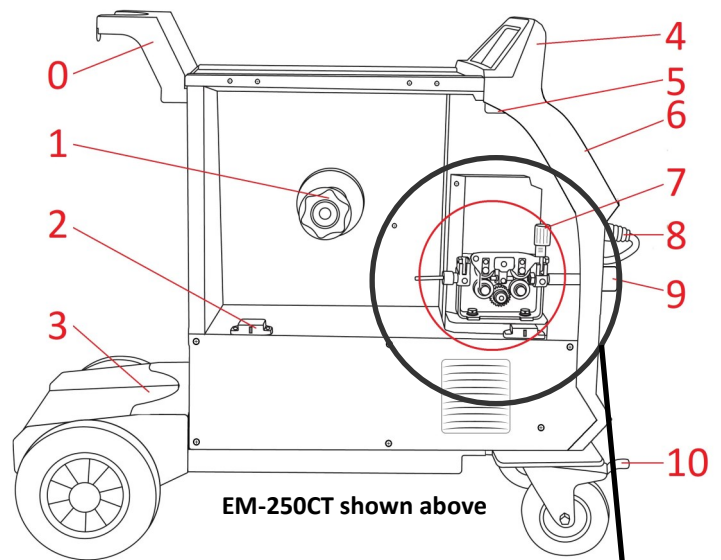

Please Note:

The drive gear for the EM-250CT feed roll system is located

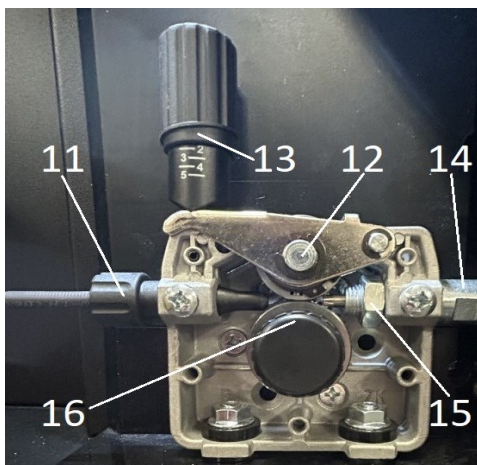

EM-200CT
2 roll drive system

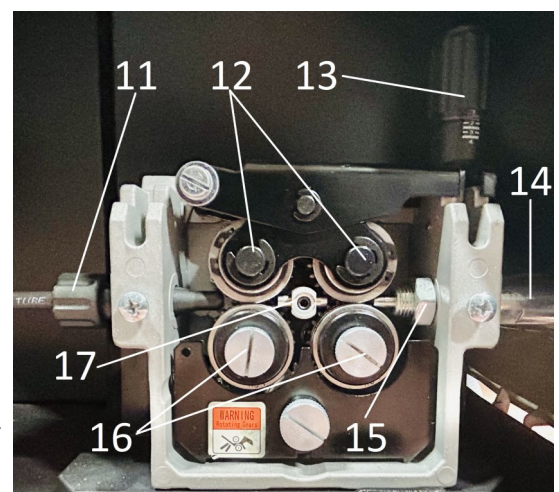

EM-250CT
4 roll drive system

INSTALLATION

Installation

The owner/user are responsible for installing and using this welding machine according to this operating manual.

Before installing this equipment, the owner/user shall make an assessment of potential hazards in the surrounding area.

Unpacking

Check the packaging for any signs of damage.

Carefully remove the machine and retain the packaging or at least until the installation is complete.

Contact your supplier in the first instance if any item is missing or damaged.

Lifting

The Jasic EM-200CT or EM-250CT does have an integrated handle although this is not to be used for lifting the machine. Always ensure the machine is lifted and transported safely and securely and never with the gas cylinder in place.

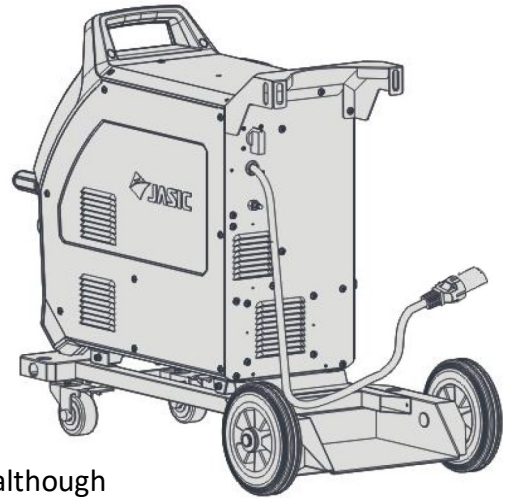

Location

The machine should be located in a suitable position and environment. Care should be taken to avoid moisture, dust, steam, oil or corrosive gases. Place on a secure level surface and ensure that there is adequate clearance around the machine to ensure natural airflow. Do not use the system in rain or snow. Position the welding power supply near an appropriate power point ensuring you leave at least 30cm of space around the machine to allow for proper ventilation.

Always place the machine on a firm level surface before using, ensuring it cannot tip over. Never use the machine on its side.

Most metals including stainless steel can give off toxic fume when welded or cut.

To protect the operator and others working in the area its important to have adequate ventilation in the work area to ensure air quality level meets all local and national standards.

Warning!



The following operation requires sufficient professional knowledge on electric aspects and comprehensive safety knowledge. All connections shall be made with the power supply turned off. Incorrect input voltage may damage the equipment.

Electric shock may cause death; after switching off the machine, there are still high voltages within the machine, so if removing the covers do not touch any of the live parts on the equipment for at least 10 minutes. Never connect the machine to the mains supply with the panels removed.

The electrical connection of this equipment shall be carried out by suitably qualified personnel and these shall be made with the power supply off. Incorrect voltage may damage the equipment.

Input power connection

Before connecting the machine you should ensure that the correct supply is available.

Details of the machine requirements can be found on the data plate of the machine or in the technical specification table shown on page 13 within this manual.

This equipment should always be connected by a qualified competent person.

Always ensure the equipment is correctly grounded.

INSTALLATION

Input Power Connection continued

1. Test with multi-meter to ensure the input voltage value is within the specified input voltage range.
2. Ensure that the power switch of the welder is turned off.
3. Wire the input mains cable wires to the correct sized mains plug, ensuring that the live, neutral and earth (ground) wires are connected correctly.
4. Carry out an electrical test of the machine if required (i.e. PAT test).
5. Ensure that the input fuse is correctly rated for the machine.
6. Connect the machine mains power plug firmly to the corresponding supply socket.

Please Note!



If the machine needs to be operated on long extension leads, then please use an extension lead where the cable has a larger cross-sectional area to reduce the voltage drop. Please consult your electrician or electrical supplier for the recommended size.

Gas Connections

The gas regulator is designed to reduce and control the high pressure gas from a cylinder or pipeline to the working pressure required for the Jasic TIG machine.

Before fitting the regulator, clean the cylinder valve outlet. Match the regulator to cylinder and before connecting, ensure the regulator and the regulator inlet and cylinder outlet match. Connect the regulator inlet connection to cylinder and tighten it firmly (do not overtighten) with a suitable spanner. If using a gas flowmeter, connect to the regulator outlet. Connect the gas hose to the regulator/flowmeter which is now located on the shield gas cylinder and connect the other end to the gas socket on the machines rear panel.

With the regulator connected to cylinder, always stand to one side of regulator and only then slowly open the cylinder valve. Slowly turn adjusting knob in (clockwise) direction until the outlet gauge indicates that you have set the required flow rate.

To reduce the gas flow rate, turn the adjustment knob anti-clockwise, until the required flow rate is Indicated on the gauge/flow meter.

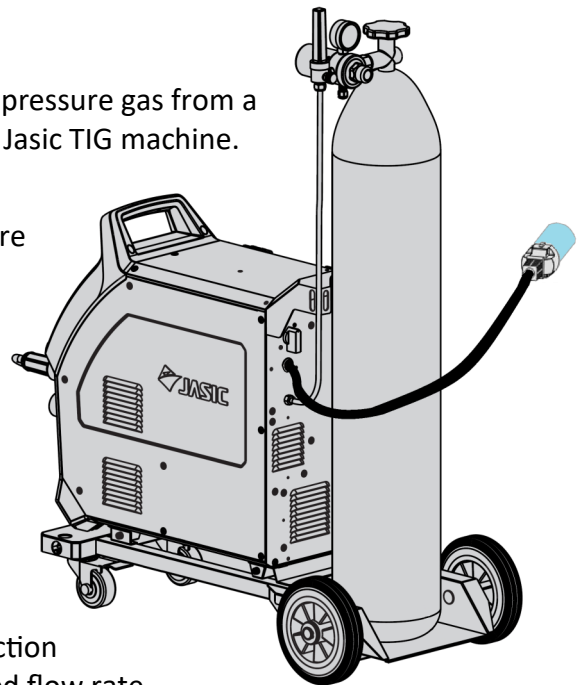

Output Power Connections

When inserting the cable plug of the work return lead, MMA electrode holder or TIG torch adapter into the dinse socket on the front panel of the welding machine, rotate it clockwise to tighten.

It is very important to check these power connections daily to ensure they have not become loose otherwise arcing may occur when used under load.

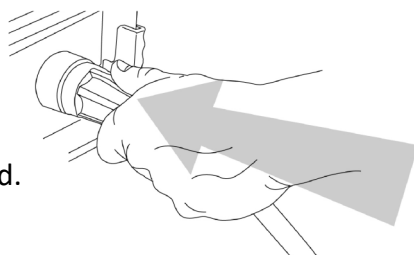

Generic library picture

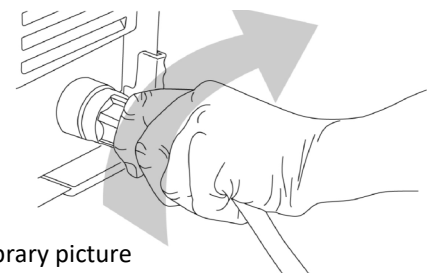

INSTALLATION OF WIRED REMOTE CONTROL (STANDARD)

Wired hand-held remote-control connection

As standard the EVO MIG EM-200CT and EM-250CT machines are fitted with a 9 pin remote control socket (1).

This allows for the matching 9 pin plug (2) of the hand held remote control or a foot pedal to be connected directly to the machine to offer the user remote operation control.

PLEASE NOTE:

Check that the machine supports a wired hand-held or foot remote control before installation.

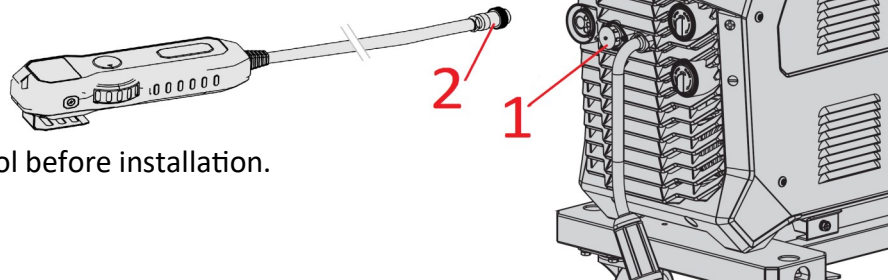

WIRELESS REMOTE CONTROL (OPTIONAL)

Wireless hand-held remote-control connection

An option with the EVO TIG range of machines is for the operator to be able to wirelessly control the welding current. To enable this, you will require to fit the optional remote interface module.

Installation of the wireless receiver module

- 1) Remove the plastic cap 'A' shown in the image right and fit the wireless receiver module as shown.
- 2) Remove the screws of the left side cover of the machine.
- 3) Remove the buckle from inside the front panel of the machine and pull out the plug.
- 4) Insert the wireless receiver module 'B' to the front panel, and then connect the connection line of the receiver module to the CN5 socket on the main board.

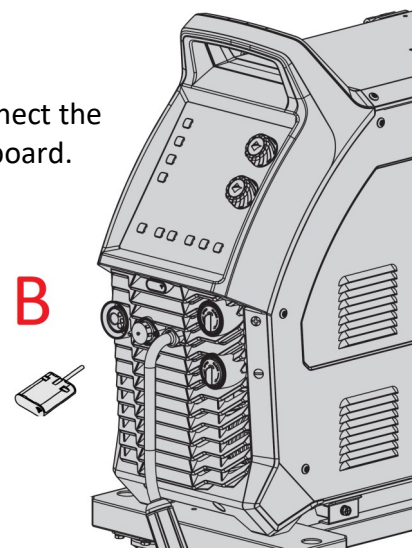
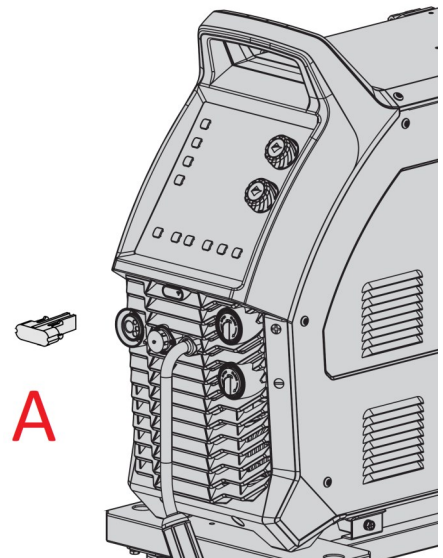

PLEASE NOTE:

Please check that the machine supports wireless hand held or foot remote controls before installation.



The above operation requires sufficient professional comprehensive knowledge of electrical circuits and electrical safety. Make sure the input cable of the machine is disconnected from the electricity supply and wait for 5 minutes before removing the machine covers.

CONTROL PANEL - JASIC MIG EM-200CT PFC and EM-250CT PFC



1. Remote control selection: Pressing this button will set current control from the panel to a remote device such as a foot pedal, TIG torch remote potentiometer or a remote control device for MMA. When in remote mode the LED indicator will also light up.
2. Synergic selector button: Turns synergic mode on or off. When in synergic mode the LED indicator will also light up.
3. Wire inch switch: When pressing this button, the feed motor will activate and feed the welding wire through the liner torch until it comes through the welding tip. When the wire is inching the LED indicator will also light up.
4. Gas purge switch: When the gas-check button is pressed, the gas will flow. When the key is pressed again gas flow will cease. When the gas is purging the LED indicator will also light up.
5. Welding process selection area and selector switch: Allows user to select MIG, MMA or Lift TIG.
6. Material and gas selection area, pressing either the up or down buttons will scroll you through the preset material and gas combinations type selector button (preset according to material selected).
7. Top digital display with rotary encoder for carrying out parameter adjustments including wire feed speed, current control and material thickness depending on welding process mode.
8. Bottom digital display with rotary encoder for carrying out parameter adjustments including voltage, inductance/arc force and burn back time depending on welding process mode.
9. Warning indicators:
 - a. The yellow warning LED will light up if the machine overheats.
 - b. The red warning LED will illuminate if the machine experiences an input mains under or over voltage situation.
 - c. The VRD indicator The VRD (Voltage Reduction Device) LED will be lit when the machine is in MMA mode and the VRD function is enabled.
10. Standard MIG gun or Spool Gun switch: This selector button allows the use of a spool gun to be used in MIG Mode, the selected LED indicator will also light up.
11. Torch trigger mode selection area: Use this selector button to choose between 2T or 4T mode for MIG torch finger switch control, the selected LED indicator will also light up.
12. MIG wire size selection area: Here you can choose between various MIG wire sizes, pressing the button will scroll you through the size options and is highlighted by the LED indicator lighting up.

CONTROL PANEL - FUNCTIONS

Digital Display

The top digital meter as shown below, is used to display many machine details including: current, wire feeding speed, plate thickness parameters and error codes etc.

Below is listed some of the data that will be noted via this display.



- When not welding, the preset current value will be displayed. If no operation is performed for set period of time, the default parameters are displayed.
- When welding, the actual output welding current value is displayed.
- In MIG, this display will show wire feed speed in meters per minute (m/min).
- In Synergic material thickness can be selected and displayed.
- When the factory settings are restored, the countdown is displayed.
- When the machines serial number is required, this display will show it.
- When the product is not working correctly, an error code is will be shown on this display.
- In welding engineer mode, the F0 number will be shown on this display
- Parameters are adjusted using the encoder dial shown in the image above
- This control dial also always for access to the background settings

In MIG Synergic mode, MMA mode or Lift TIG mode, current is displayed by default.
If Synergic mode is disabled in MIG mode, the wire feed speed is displayed by default.

Top parameter adjustment knob and button

This multi functional control knob is used to scroll through the various parameters of the welding equipment.

Depending on which welding process you have selected, by either pressing or rotating the control knob this allows the operator to select the required parameters of that welding process.

- In MIG mode, if the "Synergic" function is disabled, the wire feed speed can be set. If the function is enabled, rotate the knob to switch display of current, wire feed speed and plate thickness for configuration.
- In MMA or Lift TIG mode, the current parameter can be configured.
- Rotate the adjustment knob to adjust the parameters.
- Rotating the adjusting knob clockwise increases the parameter value, and rotating it counter clockwise decreases the value.
- When the adjustment knob is rotated, the adjusted parameter is displayed in the parameter display area.



During welding, rotating the adjustment control knob will adjust the selected parameter and these adjustments will also be noted by the array of green LED's circling the control dial.

CONTROL PANEL - FUNCTIONS

Digital Display

The bottom digital meter as shown below, is used to display the voltage, inductance/arc force and burn back time.



- When not welding, the preset value of voltage is displayed. If no operation is performed for a long time, the default parameters are displayed.
- When welding, the actual output voltage is displayed. The voltage is displayed by default in all welding modes.
- Inductance can be displayed and adjusted when in MIG mode
- Burn back time will be shown and adjusted when in MIG mode
- Arc force can be adjusted when in MMA
- When the product is not working correctly, this display is used to show an error code.
- In welding engineer mode, the F'O' number options will be shown on this display

Bottom parameter adjustment knob and button

This multi functional control knob is used to scroll through the various parameters of the welding equipment.

Depending on which welding process you have selected, by either pressing or rotating the control knob this allows the operator to select the required parameters of that welding process.

- In MIG mode, rotating this control to welding voltage, welding inductance and burn back time for configuration.
- In MMA mode, rotating control knob will adjust and set welding current and arc force setting.
- In Lift TIG mode, rotating control knob will adjust and set the welding current.
- Pressing the control knob will adjust between the parameters, voltage, inductance/arc force and burn back time.
- Rotating the knob clockwise increases the selected parameter value, while rotating it counter clockwise decreases the value.
- When the adjustment knob is rotated, the adjusted parameter is displayed in the parameter display along side.

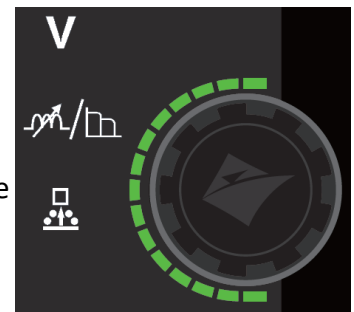



During welding, rotating the adjustment control knob will adjust the selected parameter and these adjustments will also be noted by the array of green LED's circling the control dial.

CONTROL PANEL - FUNCTIONS

Welding mode selection area and switch

The welding mode selection zone (shown right) contains the welding mode selection switch and corresponding indicators MIG, MMA and Lift TIG.

Pressing the green mode selection key  will allow you to choose the required welding mode and the corresponding indicator will be lit according to your selection.

If the  indicator is on, it indicates that MIG mode has been selected.

If this  indicator is on, it indicates that MMA mode has been selected.

If the  indicator is on, it indicates that Lift TIG mode has been selected.



TIG torch trigger modes



Torch trigger function modes: 2T, 4T, repeat and spot. Press the 'mode' key to select the required welding trigger mode and depending on your selected TIG torch trigger option the corresponding LED indicator will illuminate, see page 37 for further details.



Base metal and gas selecting zone

This control allows you to select the base metal and welding gas mixture options which include:

- ⇒ Carbon steel with 80% Ar + 20% CO₂
- ⇒ Steel flux cored with 80% Ar + 20% CO₂
- ⇒ Carbon steel with 100% CO₂
- ⇒ Steel flux cored with 100% CO₂
- ⇒ Stainless Steel with 98% Ar + 2% CO₂
- ⇒ Steel flux cored with 100% CO₂
- ⇒ Aluminium Mg with 100% AR

Users can select the desired base metal and gas combination by pressing the selecting keys  

Pressing either of these buttons will rotate the selection choice to light up the LED of the material/gas required to be used.

Note: This function is not applicable when MMA mode is selected.

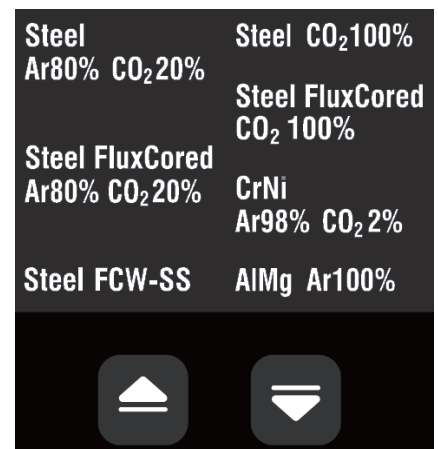

MIG Wire diameter selecting zone

Welding wire diameter options include solid wire of:

- ⇒ Φ 0.6mm
- ⇒ Φ 0.8mm
- ⇒ Φ 1.0mm
- ⇒ SP

The operator can select the desired wire diameter by pressing the selecting key and the corresponding LED will then illuminate to indicate which diameter sized wire is selected.

Notes: - Wire selection function is not changeable during welding or when in MMA mode.
- SP option is not available on all models.



CONTROL PANEL - FUNCTIONS

Warning indicators

Over temperature



The overheat indicator light indicates that the machine has entered overheat protection and has stopped welding output, the machine will re-activate once the unit has cooled down.

Do not turn off the machine when this indicator illuminates, wait for a while, and then continue welding after the overheat indicator has turned off.

Over Current



The over-current indicator light indicates that the machine has entered over-current protection and has stopped the output. Reset the machine by turning off and then back on.

If this error persists, please contact your supplier for further assistance.

Remote Control Switch



The remote selection control allows the user to select current control from either the front panel or to be controlled remotely either via the 9 pin control socket or via the optional wireless control. The LED indicator alongside the remote button indicates whether remote control is enabled or not.

- If the LED is OFF then current control is via the control panel and the panel adjustment dial will alter the welding amperage
- If the LED is ON then a connected wired or wireless hand/foot control will start the welding process and control the amperage.

Depending to the remote device connected, remote control facility is effective for MIG, TIG and MMA operating.

Synergic Control Switch



This button allows the user to turn synergic mode ON or OFF.

With Synergic mode turned on means the machine will automatically match the welding parameters according to the current, wire feed speed, material thickness with material type, gas and wire diameter size.

On the EVO MIG machine, there are a multitude of pre-configured settings being changed by the software to provide the best welding characteristics possible. The corresponding LED will light up to indicate that you are in synergic mode.

Wire Inch Switch

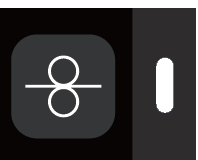

When pressing and holding the wire inch button, the wire feed motor will run and feed the welding wire through the drive system, into the MIG torch liner until it comes through the welding tip. The corresponding LED will light up to indicate that you are feeding the welding wire. Releasing the button will stop the wire feed.

Gas Purge Switch



This control button allows the operator to activate the shielding gas allowing for checking and setting the gas flow. When the gas purge button is pressed, shielding gas will flow and will continue to flow until the purge button is pressed again. The gas flow LED will be on while the gas is flowing.

The operator can also deactivate gas flow by pushing the torch trigger or any other button on the control panel while in gas purge check mode.

Note: If the button is not pressed to exit the gas purging will exit automatically after 30 seconds.

CONTROL PANEL - FUNCTIONS

VRD indicator



The VRD LED will be lit when the machine is in MMA mode and the VRD function is enabled. When the VRD indicator is lit the output voltage is 11.5V.

Please Note:

- The VRD LED will go off when the welding arc is established.
- VRD is factory set to ON, this can be disabled although requires a technician to carry out this task, please contact your supplier for further details.
- If the VRD function is enabled and no welding is in process although the VRD indicator light is red, this indicates that the VRD function is abnormal.

Serial Number Display



When the machine is in its idle state (before welding), press and hold both the welding mode button  and the parameter adjustment dial button (as shown below) for 3 seconds to display the machines serial number.

The barcode is displayed in nine groups of data in the top display screen only, including "1.XY", "2.XY" to "9.XY" where X and Y are figures from 0 ~ 9.

Refer to the below table for details:

Rotating the encoder will allow the operator to scroll through to see the full serial number from the display. Pressing any key will clear the serial number from the display.

Please Note:

The 12th - 19th digits in the digital barcode are the company's internal fixed numbers, which are not displayed in the window.

Read the 9 groups of data and arrange them in order from left to right, skipping the 12th - 19th digits, to get the barcode of the machine.

Data displayed	Meaning
1.XY	X and Y represent the 1 st and 2 nd digits/letters of the digital barcode respectively
2.XY	XY represents the 3 rd digit/letter of the digital barcode, and YX is from 11-45, corresponding to the barcode D-Z and representing the year
3.XY	XY represents the 4 th digit/letter of the digital barcode, and YX is from 01-12, corresponding to the barcode 0-C and representing the month
4.XY	XY represents the 5 th digit/letter of the digital barcode, and YX is from 01-31, corresponding to the barcode 0-V and representing the date
5.XY	X and Y represent the 6 th and 7 th digits/letters of the digital barcode respectively
6.XY	X and Y represent the 8 th and 9 th digits/letters of the digital barcode respectively
7.XY	X and Y represent the 10 th and 11 th digits/letters of the digital barcode respectively
8.XY	X and Y represent the 20 th and 21 st digits/letters of the digital barcode respectively
9.XY	X and Y represent the 22 nd and 23 rd digits/letters of the digital barcode respectively

If you do not carry out any welding operation or touch any control button on the panel, the serial number will clear automatically from the display after 20 seconds.

CONTROL PANEL - SETTINGS

Configuration Settings

Welding Engineers Mode functions



The Welding Engineer Mode function allows users to adjust and Set background default parameters or functions as follows:
Press and hold the top parameter adjustment knob for 5s in startup state.

After pressing and holding the top parameter adjustment knob" for 2s, the machine will count down from 3s; at the end of the countdown, the top display window will display a parameter number, such as "F01" and the bottom parameter display will show a value corresponding to that number.

Rotating the top parameter adjustment dial will allow you to select the parameter number to set the back-end parameter default value or function.

Rotating the bottom parameter adjustment dial will set the value corresponding to that parameter number. Pressing the top parameter adjustment dial will to save the new value.

After setting the value, press the welding mode selection key  to exit welding engineers mode.

Refer to the following table for the parameter numbers, function definitions and configuration values

Upon selecting your chosen response time, press the control dial to save the current settings. Then press the welding mode button to complete the operation and exit.

Background function	Parameter no.	Default value	Function definition
Standby time adjustment function	F01	10	Can be set to four values: "0", "5", "10" or "15". "0" indicates that the standby function is disabled and the machine will not enter standby state. "5", "10" and "15" indicate that the standby function is enabled and the machine will enter the standby state after the corresponding time in minutes.
Input overvoltage/undervoltage protection	F02	0	Can be set to "0" or "1". "0" indicates that the overvoltage/undervoltage protection function is disabled and OFF. "1" indicates that the overvoltage/undervoltage protection function is enabled and active.
Pre-flow time	F03	MIG: 0.1 Lift TIG: 0.5	Setting Pre-flow time for either MIG or Lift TIG will depend on which welding mode you are in when entering Welding Engineer Mode. If the "Welding Mode" is MIG, set the MIG pre-flow time, with range 0 ~ 2.0, adjustments of 0.1 and unit in seconds. If the "Welding Mode" is Lift TIG, set the Lift TIG pre-flow time, with range 0 ~ 5.0, accuracy of 0.5, and unit of seconds.

CONTROL PANEL - SETTINGS

Configuration Settings

Welding Engineers Mode functions (continued)

Background function	Parameter no.	Default value	Function definition
Post-flow time	F04	MIG: 0.5 Lift TIG: 5	Setting Port-flow time for either MIG or Lift TIG will depend on which welding mode you are in when entering Welding Engineer Mode. If the "Welding Mode" is MIG, set the MIG post-flow time, with range 0 ~ 5.0, accuracy of 0.5, and unit of seconds. If the "Welding Mode" is Lift TIG, set the Lift TIG post-flow time, with range 0 ~ 10, accuracy of 0.5, and unit of seconds.
Lift TIG downslope time	F05	0.5	Set the Lift TIG downslope time, with range 0 ~ 5, adjustments in 0.5 seconds.
Burn back voltage	F06	13	Set the MIG burn back voltage, with range 10 ~ 20, Adjustments in 0.1 volts.
Hot start current	F07	30	Set the MMA hot start current, with range 0 ~ 60, adjustments of 1 and unit of amperes.
Initial wire feed speed rate	F08	1	Setting the 'initial' wire feed speed rate of MIG wire which can be set to either "0", "1", "2" or "3". "0" indicates that the slow wire feed function is disabled. "1", "2" or "3" indicate that the slow wire feed speed is 1/3, 1/2 or 2/3 of the current set speed, respectively.
Remote control mode	F09	0	Can be set to "0" or "1" to use either wireless or wired remote controller. "0" indicates wireless remote control mode is active. "1" indicates wired remote control mode is active.

Please Note:

If entering the Welding Engineering Mode from different welding modes i.e. MIG or Tig for example, the functional definition corresponding to the background parameters/functions may also differ!

For example:

If entering the Welding Engineering Mode background from the MIG welding mode, the pre-flow or post-flow time set are the pre-flow/post-flow time of MIG mode.

Some models may not support F09, please confirm with the seller whether the machine supports wireless remote control function first before purchasing.

CONTROL PANEL - FUNCTIONS

Configuration Settings (Engineers mode)

Restore Factory Settings



To reset to factory settings for the EM-200CT or the EM-250CT, press and hold the welding mode button  for 5 seconds to restore all factory settings.

After holding the button for 1 second the display window will show the start of a count down from 3 to zero.

When the countdown ends, the factory settings are restored.

If the button is released before the countdown ends, the restore will not have taken place.

Factory settings are detailed and shown in the table below.



Welding Process	Parameter	Restored Parameter Value EVO EM-200CT	Restored Parameter Value EVO EM-250CT
MIG parameters	Burn back time	0.2S	0.2S
	Burn back voltage	13V	13V
	Inductance	0	0
	Pre-flow time	0.1S	0.1S
	Post-flow time	0.5S	0.5S
	Welding voltage	19.0V	19.0V
	Wire feeding speed	5m/min	5m/min
	Crater voltage	19.0V	19.0V
	Crater feeding speed	5m/min	5m/min
MMA parameters	Arc-force current	40A	40A
	Hot start current	30A	30A
	Welding current	130A	130A
Lift TIG parameters	TIG downslope time	0.5S	0.5S
	Welding current	100A	100A

CONTROL PANEL - FUNCTIONS

Wired (Foot pedal / hand-held) Remote Control

A 9 pin remote control socket is fitted as standard to the front panel of the machine, see pages 78/79 for optional remote controls)





- 1) Before welding, press the remote-control function  button to enable the remote control function.
- 2) The indicator  will be lit indicating that the remote-control function is enabled.
If the remote controller is connected, the remote control device controls the welding current.
If no remote controller is connected then the welding current is controlled by the panel control dial.
- 3) If the indicator  is not lit, this indicates that the remote-control function is not active and welding current is controlled by the front panel control dial.



Wireless Remote Control (optional)

(Wireless remote control interface is optional, see pages 78/79 for remote options)



1) Wireless pairing connection

Before welding, press and hold the panel remote control function button  and the pairing button  of the wireless remote controller at the same time, hold for 2 seconds to perform wireless remote control pairing.



During pairing, the blue indicator of wireless receiver module  flashes, after successful pairing, the indicator  of remote control mode is on .

At the same time the blue indicator of wireless receiver module  will be constant on and the welder display window displays "OK".

After successful pairing, the welding current can be adjusted by "+" or "-" buttons on the wireless remote controller.

The range of current is from the machines minimum to the maximum current value which was previously displayed as preset current on the panel.

2) Disconnecting the wireless connection

After the remote controller is successfully paired, press the remote control function button  on the panel or the pairing button  of the wireless remote controller for 2 seconds, and the wireless connection of the remote controller will be disconnected.

After disconnecting the display window of the welder displays the character "FAL", and the green indicator of the wireless receiver module  will be constantly on.

REMOTE CONTROL SOCKET

The Jasic MIG EM-200CT and EM-250CT are fitted with 9 pin remote control socket located on the front panel which is used to connect various remote control devices, for example: a TIG torch with trigger switch, a TIG torch with mounted switch and current adjustment dial, a foot pedal or other similar devices including MMA remote control devices.

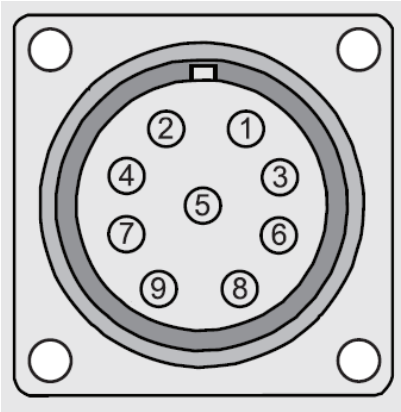

9pin Remote Socket Pin Out Details		
Pin No.	Signal symbol	Signal
Pin1	VCC	Power supply
Pin2	ASI	Analog signal
Pin3	A_GND	Analog signal GND
Pin4	/	/
Pin5	/	/
Pin6	TYPE1	Foot pedal controller recognition
Pin7	TYPE / Motor V+	Analog signal recognition / Motor driving power V+
Pin8	FRC_SWI / Motor V-	Foot pedal remote switch signal / Motor driving power V-
Pin9	GND	GND

When fitting the 9 pin remote plug, ensure you align the keyway when inserting the plug, then rotate the threaded collar fully clockwise until finger tight.

The 9 pin plug and clamp part number is: JSG-PLUG-9PIN

Remote device activation



As with the previous page, to activate remote, press the remote button and the remote LED will illuminate (as shown left), this indicates that the machine is ready to be used with a remote control device.

Pressing the remote button again will turn off remote control.

Lift TIG Torch (Trigger only) as follows:

Use our Euro style TIG torch (which uses euro trigger pins to start arc)

Part Number: WP26-12JE WP26 Euro Style TIG Torch 4m

Spool Gun and Push pull torch remote control wiring as follows:

- Pin 1 – Potentiometer Max
- Pin 2 – Potentiometer Wiper
- Pin 3 – Potentiometer Min
- Pin 7 – '+' Motor feed DC24V
- Pin 8 – '-' Motor feed 0v
- Pin 9 – GND

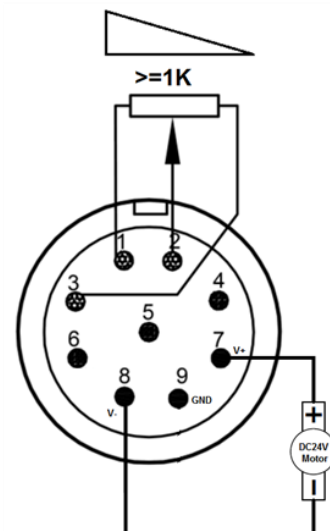

OPERATION MIG

MIG/MAG welding

Insert the welding torch (C) into the “Euro connector for torch in MIG” output socket on the front panel of the machine and tighten it.

Insert the trailing cable plug (A) into the “+” output terminal of the welding machine and tighten it clockwise.

Insert the work return lead cable plug (B) into the “-” output terminal on the front panel of the welding machine and tighten it clockwise.

Install the welding wire on the spindle adapter.

Connect the cylinder equipped with a gas regulator to the gas inlet on the back panel of the machine with a gas hose. Correctly set the gas pressure and flow.

Ensure that the roller groove size on the fitted drive roll matches the contact tip size of the

welding torch and the wire size being used.

Release the pressure arm of the wire feeder to thread the wire through the guide tube and into the drive roll groove and then adjust the pressure arm, ensuring no sliding of the wire. (too much pressure will lead to wire distortion which will affect wire feeding performance).

Pressing the wire inch button will activate the feed motor only and will start to feed the wire through the torch until the wire comes through the contact tip.

You are now ready to start MIG welding.

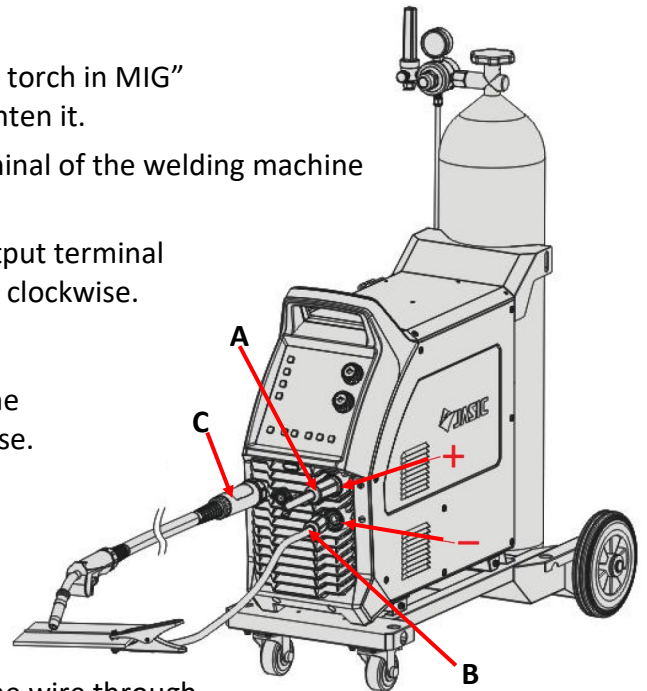

MIG welding using gasless, self shielded MIG wire

Insert the welding torch (D) into the “Euro connector for torch in MIG” output socket on the front panel of the machine and tighten it.

Insert the work return cable plug (E) into the “+” output terminal of the welding machine and tighten it clockwise.

Insert the trailing cable plug (F) into the “-” output terminal on the front panel of the welding machine and tighten it clockwise.

Install the wire spool on the spindle adapter ensuring that the roller groove size on the drive roll fitted matches the contact tip size of the welding torch and the wire size being used.

Release the pressure arm of the wire feeder to thread the wire through the guide tube and into the drive roll groove.

Adjust the pressure arm ensuring no sliding of the wire. (Too much pressure will lead to wire distortion which will affect wire feeding performance).

Pressing the wire inch button will activate the feed motor only and will start to feed the wire through the torch until the wire comes through the contact tip.

You are now ready to start MIG welding.

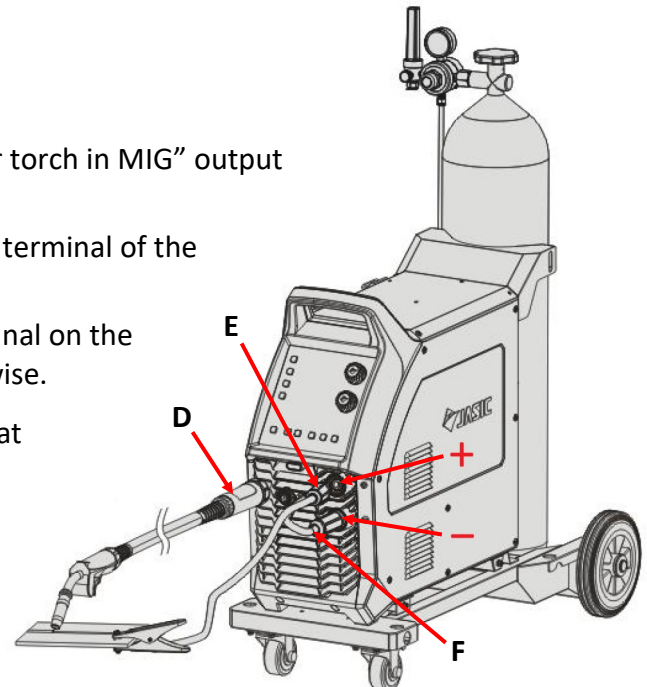

OPERATION - MIG



Before starting any welding activity ensure that you have suitable eye protection and protective clothing. Also take the necessary steps to protect any persons within the welding area.

MIG/MAG Standard Welding Mode

MIG - Metal Inert Gas Welding, MAG - Metal Active Gas Welding, GMAW - Gas Metal Arc Welding

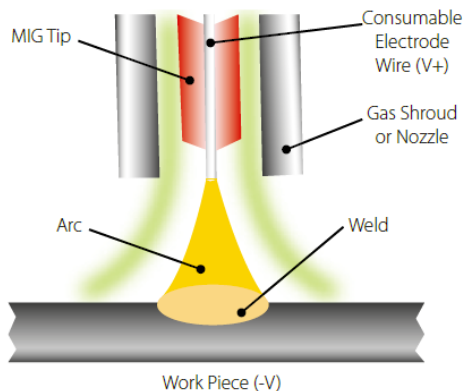

MIG welding was developed to help meet production demands of the war and post war economy which is an arc welding process in which a continuous solid wire electrode is fed through a MIG welding gun and into the weld pool, joining the two base materials together.

A shielding gas is also sent through the MIG welding gun and protects the weld pool from contamination which also enhances the arc.

Connect the MIG torch leads as detailed on page 30. Work return lead to '-' (B) and torch trailing lead to '+' (A).

Ensure that a suitable shielding gas supply is connected.

Switch the power switch on the back panel to "ON" the machine is started with the control panel lighting up and the cooling fans will initially start running.

Open the gas valve of the cylinder and adjust the gas regulator to obtain the desired flow rate.

Depending on your exact MIG welding requirements you can follow the instructions below to obtain your optimum setup.

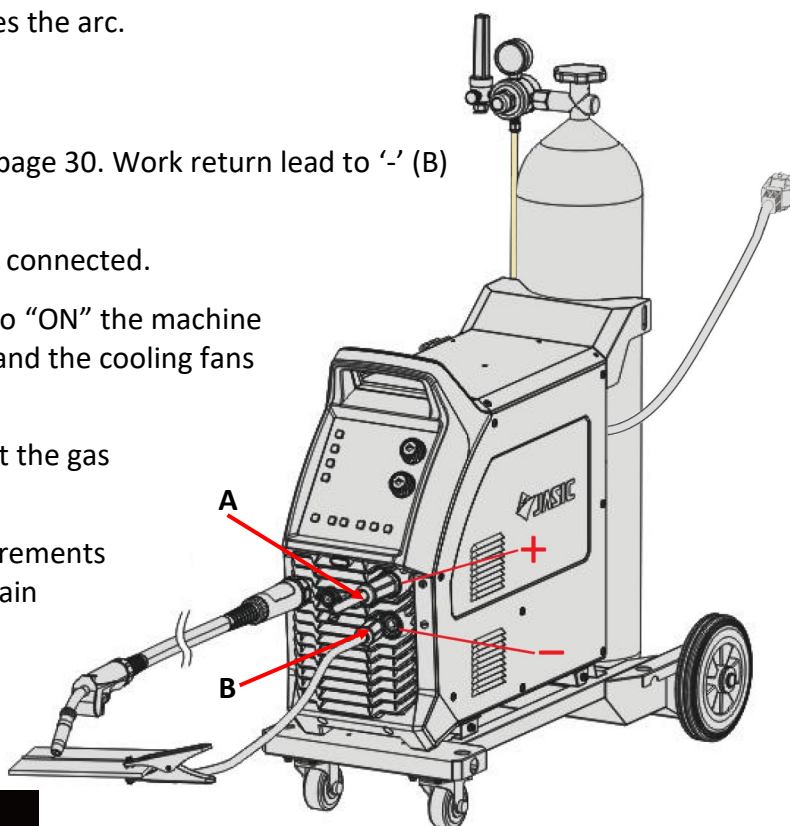

Standard Welding Mode:



Once the machine has been setup for MIG (as above along with page 30) you will be in a position to setup the control panel for your MIG welding task.

The control panel image left is an example of the machine being set up for standard MIG and the following few pages will explain the setup steps of operation.

OPERATION - MIG



Before starting any welding activity ensure that you have suitable eye protection and protective clothing. Also take the necessary steps to protect any persons within the welding area.

MIG/MAG standard welding mode

Selecting MIG Welding mode:

Press the MIG/MMA/Lift TIG button (C) to select MIG welding mode. Upon selecting MIG, only the MIG mode corresponding icon will be lit.

Material and Gas combination choice:

Select the material and shielding gas being welded, materials choice includes; carbon steel, stainless steel, aluminium-silicon alloy and aluminium-magnesium alloy can be selected by pressing either of the selection buttons (D).

Upon selecting the combination gas and material choice you require, only that selected material will be lit up.

Wire size:

Press the wire size button (E) to select the size of welding wire you have fitted within the machine, wire size choice is 0.6mm, 0.8mm or 1.0mm, your wire size selection choice may be restricted on which material or welding process you have previously selected.

Upon selecting your MIG wire size choice, only that wire size icon will be illuminated. The corresponding indicator will be lit according to selected operation method.

Remote control selection

The remote selection control allows the user to select current control from either the front panel or to be controlled remotely either via the 9 pin control socket or via the optional wireless control for MIG, (MMA or TIG) remote control devices.

The LED indicator alongside the remote button (F) indicates if remote control is enabled or not.

Synergic mode:

For standard MIG, ensure that synergic mode is OFF. The synergic option can be selected by pressing the button (G) to make the synergic programs effective.

Synergic mode, offers the operator the ability to adjust one control which in turn adjusts the other background welding parameters automatically.

The synergic indicator will be lit when operating in synergic mode.

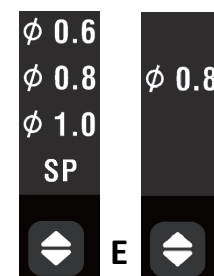
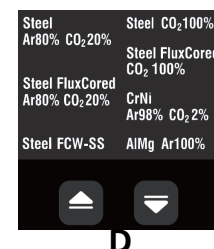
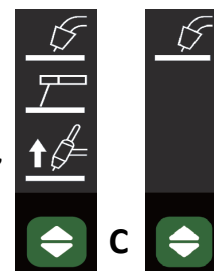

Please Note:

Depending on your material and gas selection you may note that the welding wire size selection choice maybe restricted. These settings are determined by the software based on the welding difference between steel and aluminium materials.

OPERATION - MIG



Before starting any welding activity ensure that you have suitable eye protection and protective clothing. Also take the necessary steps to protect any persons within the welding area.

MIG/MAG standard welding mode

Trigger Mode:

Select the 2T torch trigger mode by pressing the torch mode button (H) until the 2T icon is illuminated as shown right.

For alternative trigger modes details, please see page 37.



Standard MIG Torch or Spool Gun Mode:

The Jasic EM-200CT and EM-250CT machines can be used with the optional spool gun part number JE-SP250-6 which is a Euro style spool gun which will connect to the machine via the Euro outlet connector.

Pressing the MIG torch type button (J) to select either standard MIG torch or the spool gun torch option depending on which is fitted.

The corresponding indicator will be lit according to your selection.

See page 45 for further information on spool gun use.

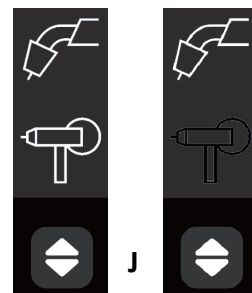

Wire Feed Speed Control

The control dial and display area (K) is a combined rotary encoder and selection push button which when rotated in standard MIG mode gives the operator the ability to control wire feed speed.

Rotating the control dial clockwise increases wire feed speed (increasing welding current) while rotating the dial anticlockwise will decrease the wire feed speed ultimately reducing welding current.

(The wire feed speed range is 2 ~ 14 m/min).

MIG Voltage Control

The control dial and display area (L) is a combined rotary encoder and selection push button which when rotated in standard MIG mode gives the operator the ability to control welding voltage.

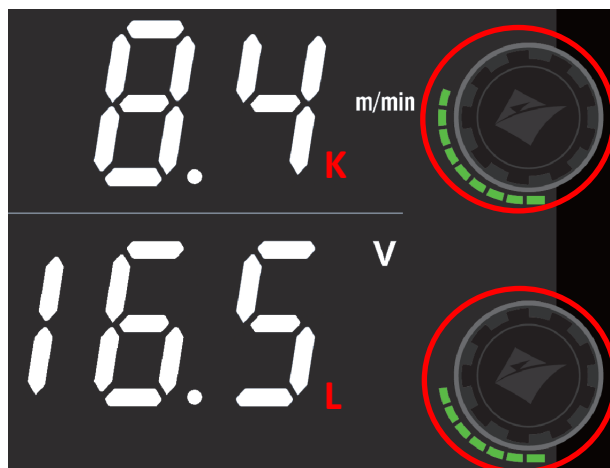

Inductance and Burn Back Controls

In standard MIG the top dial (K) is only for controlling wire feed speed although the lower dial (L) will control the following:

V	Welding Voltage	(welding voltage adjustment range is 11 ~ 26V)
	Inductance	(Inductance adjustment range is -10 ~ +10)
	Burn Back Time	(Burnback time adjustment range is 0 ~ 800ms)

To access inductance and burnback time, simply press the lower control dial (L) which will scroll you through these 3 options. Please refer to page 19 for further information.

OPERATION - MIG



Before starting any welding activity ensure that you have suitable eye protection and protective clothing. Also take the necessary steps to protect any persons within the welding area.

MIG/MAG standard welding mode

When in standard MIG mode, you can now adjust various MIG parameters such as pre & post gas flow, burnback voltage and initial slow wire feed speed and these which are adjusted via the welding engineer mode (WEM) function that allows the users to adjust a number of background default parameters or functions.

To access WEM, press and hold the top adjustment knob (K as per previous page) for 5 seconds, after pressing and holding this knob for 2s, the machine will show a count down from 3 seconds, at the end of the countdown, the top display window will show the parameter number "F01" with the bottom parameter displaying the value corresponding to that 'F' number.

By rotating the top parameter adjustment dial will allow you to select the required parameter number to set the back-end parameter default value or function (see pages 25 onwards for further details).

- **MIG pre-gas selection and adjusting:**

To select pre flow gas time setting, rotate the top adjustment dial until F03 is displayed, by rotating the bottom dial, you can then adjust the pre flow time shown in the bottom display window. The pre flow adjustment range is 0 ~ 2 seconds and the factory setting is 0.1 seconds.

- **MIG post-gas selection and adjustment:**

To select post flow gas time setting, rotate the top adjustment dial until F04 is displayed, by rotating the bottom dial, you can then adjust the pre flow time shown in the bottom display window. The pre flow adjustment range is 0 ~ 5 seconds and the factory setting is 0.5 seconds.

- **Burnback voltage adjustment:**

To select and adjust downslope time, rotate the top adjustment dial until F06 is displayed. Then by rotating the bottom dial you can then adjust the burnback voltage is shown in the bottom display window. The burnback voltage range is 10 ~ 20 volts and the factory setting is 13 seconds.

- **Initial wire feed speed adjustment (also known as creep speed):**

To select and adjust the initial 'slow' wire feed speed, rotate the top adjustment dial until F08 is displayed. Then by rotating the bottom dial you can then turn on and adjust the initial feed rate speed that is shown in the bottom display window.

The initial wire feed speed settings are as follows:

"0" indicates that the slow wire feed function is disabled. "1", "2" or "3" indicate that the slow wire feed speed is 1/3, 1/2 or 2/3 of the set wire feed speed respectively. The factory setting is 1.

Once any adjustments are carried out, pressing the green button exits the welding engineers mode and saves your settings.

MIG - Gasless

The operation method is the same as the above MIG operation except there no shielding gas is used and the output polarity for the MIG torch and the work return lead is reversed (see page 30).

OPERATION - MIG



Before starting any welding activity ensure that you have suitable eye protection and protective clothing. Also take the necessary steps to protect any persons within the welding area.

MIG/MAG Synergic Welding Mode

Synergic Welding Mode:

Synergic mode is where Welding Power (Voltage) and Wire Feed Speed are adjusted together, rather than separately, via a single Control.

The EVO range of MIG welders have been pre-program with various welding parameters including; MIG welding wire size, the material type and shielding gas being used.

With this information, the machine sets itself up with the ideal parameters for welding.

You can then for added convenience set additional features such as material thickness being welded.

In most cases, It's wire feed speed within the machine's Synergic Program then sets the welding power output to match your application. So, increasing wire feed speed will increase the machines power output to suit.

The initial machine setup is as standard MIG (see from page 30/31) for further details.



The control panel image left is an example of the EVO machine being set up in synergic MIG mode and the following few pages will explain the setup steps of operation.

Following on from the standard MIG mode selecting synergic is easily actioned by pressing the synergic mode button so that the synergic indicator is lit 'M' (as shown left).

You may also have noted that the top display has now defaulted to amperage rather than wire feed speed 'N' (as shown left).

Synergic Welding Control:

When in synergic mode welding amperage control becomes the default adjustment setting (as shown above, and the upper rotary encoder and push button which when pressed will scroll the operator through amperage control, wire feed speed and material thickness.

Synergic mode allows the operator to rotate the control dial clockwise to increases not only the welding current but also the background wire feed speed and material thickness settings and rotating the dial anticlockwise will decrease the wire feed speed ultimately reducing welding current.

Arc Length control:

In synergic mode, you can increase or decrease arc length voltage by $-5 \sim +5$ volts of the programmed value. "0" is the mid point and when accessed will be shown in the lower display. Turning the lower control dial anti-clockwise to shorten the arc length and rotating clockwise to lengthen the arc length.

OPERATION - MIG



Before starting any welding activity ensure that you have suitable eye protection and protective clothing. Also take the necessary steps to protect any persons within the welding area.

MIG/MAG Synergic Welding Mode

Synergic Welding Control:

The top control dial and display area (P) when synergic mode is selected amperage control becomes the default adjustment setting on this display (as shown left). The combined rotary encoder and push button which when pressed will scroll the operator through amperage control, wire feed speed and material thickness as shown below:



A Amperage control - (welding voltage range will vary depending on material and wire size selected)

m/min Wire Feed Speed control - (Wire feed speed will vary depending on material/wire size selected)

↕ Material thickness setting - (material thickness range will vary depending on material/wire size selected)

For example, when rotating the encoder in synergic mode gives the operator the ability to adjust the welding current and rotating the control dial clockwise increases not only the welding current but also the background wire feed speed along with the material thickness settings.

While rotating the control dial anticlockwise will decrease the wire feed speed ultimately reducing welding current.

Synergic Welding Control:

The bottom control dial and display area (Q) when synergic mode is selected welding voltage is the default adjustment setting on this display (as shown right). The combined rotary encoder and push button which when pressed will scroll the operator through welding voltage, arc length, inductance and burn back as shown below:



Voltage, Inductance and Burn Back Controls

V Welding Voltage (welding voltage adjustment range is 11 ~ 26V)
Arc Length Voltage (noted by the 'V' icon flashing, arc length voltage range is -5 ~ +5 volts)

↗/↘ Inductance (Inductance adjustment range is -10 ~ +10)

⏏ Burn Back Time (Burnback time adjustment range is 0 ~ 800ms)

To access welding voltage, arc length voltage, inductance and burn back time, simply press the lower control dial (Q) which will scroll you through these 4 options. Please refer to page 25 for further information.

OPERATION - MIG

Torch trigger operation modes

2T operation mode

Press the torch trigger to ignite the welding arc, the arc is extinguished when you release the trigger.

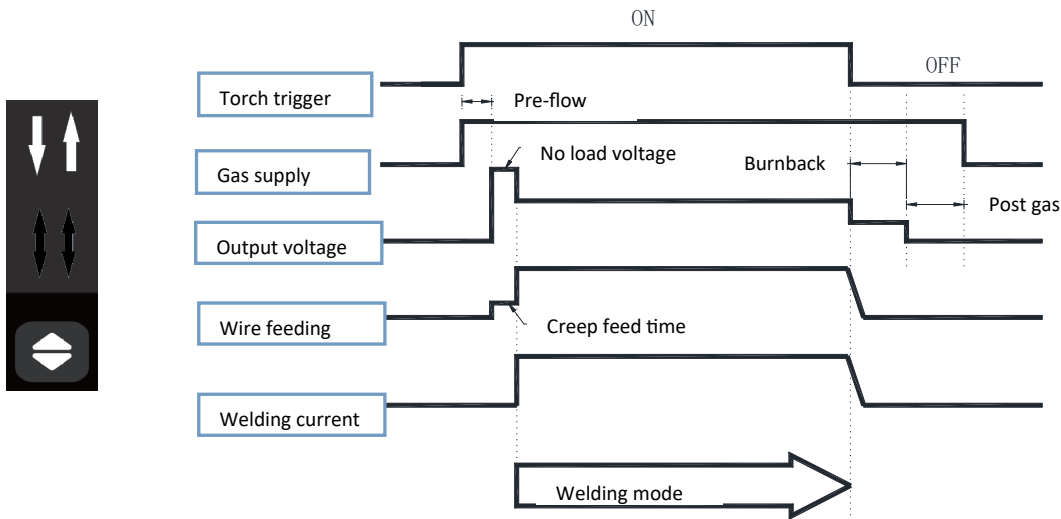

4T operation mode

When the torch trigger is pressed to start the process, welding begins and continues to work even after the torch trigger is released (current and voltage setting dials on the control panel will still adjust the welding condition).

At this time, the digital meters will display the actual current and voltage respectively.

When torch trigger is pressed again, stopping the arc is effected (welding/crater current and crater voltage parameters in the welding settings can adjust welding condition).

The welding process stops when the torch trigger is released and post flow gas time will start.

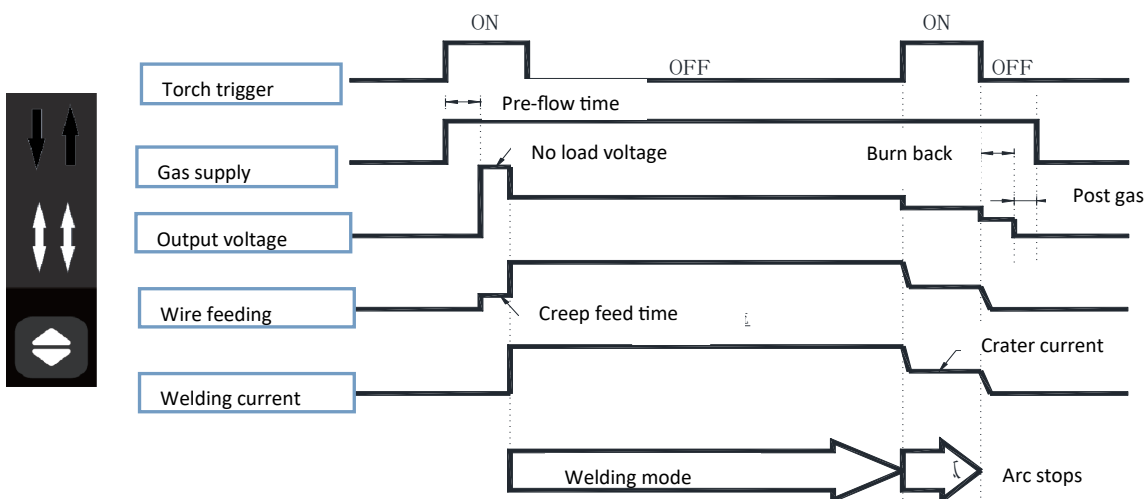

GUIDE TO MIG/MAG WELDING



Before starting any welding activity ensure that you have suitable eye protection and protective clothing. Also take the necessary steps to protect any persons within the welding area.

MIG process description

The MIG process was first patented for the welding of aluminium in 1949 in the USA. The process uses the heat that is generated by an electric arc formed between a bare consumable wire electrode and the work piece. This arc is shielded by a gas to prevent oxidation of the weld.

In the MIG process an inert shielding gas is used to protect the electrode and weld pool from contamination and enhance the arc. Originally this gas was helium.

In the early 1950's the process became popular in the UK for welding aluminium using argon as the shielding gas. Development in the use of different gases resulted in the MAG process. This is where other gases were used, for example, carbon dioxide and sometimes users

refer to this process as CO² welding. Gases such as oxygen and carbon dioxide were added and are active constituents to the inert gas to improve the welding performance. Although the MAG process is in common use today it is still referred to as MIG welding although technically this is not correct. This process began to prove itself as an alternative to stick electrode (MMA) and TIG (GTAW) offering high productivity and deposition rates.

The process also helps reduce any weld defects from the increased stop/starts used in MMA. However, the welder must have a good knowledge of the system set up and maintenance to achieve satisfactory welds.

The electrode MIG gun is normally +VE and the work return is normally -VE. However, certain consumable wires sometimes require what is called reverse polarity i.e. Electrode -VE or work +VE. Typically these types of wire are cored wires used in hard facing or high deposition and gasless applications.

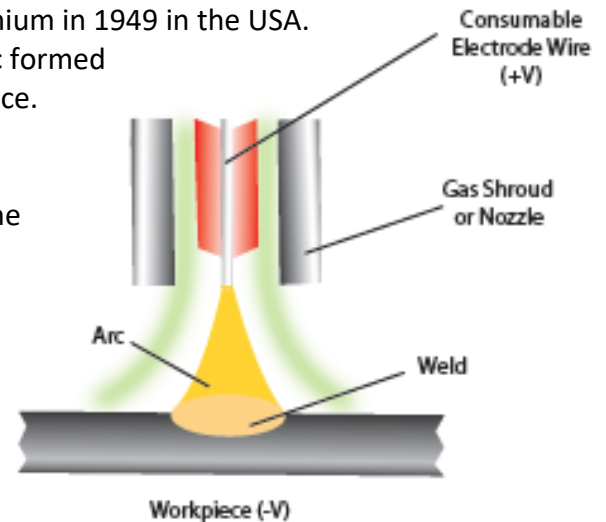

Typical welding ranges

Wire Diameter (mm)	DIP Transfer		Spray Transfer	
	Current (A)	Voltage (V)	Current (A)	Voltage (V)
0.6	30 ~ 80	15 ~ 18	n/a	n/a
0.8	45 ~ 180	16 ~ 21	150 ~ 250	25 ~ 33
1.0	70 ~ 180	17 ~ 22	230 ~ 300	26 ~ 35
1.2	60 ~ 200	17 ~ 22	250 ~ 400	27 ~ 35

GUIDE TO MIG/MAG WELDING



Before starting any welding activity ensure that you have suitable eye protection and protective clothing. Also take the necessary steps to protect any persons within the welding area.

Notes for the welding beginner

This section is designed to give the beginner who has not yet done any welding some information to get them going. The simplest way to start is to practice by running weld beads on a piece of scrap plate. Start by using mild steel (paint free) plate of 6.0mm thick and using 0.8mm wire. Clean any grease, oil and loose scale from the plate and fix firmly to your work bench so that welding can be carried out. Make sure that the work return clamp is secure and making good electrical contact with the mild steel plate, either directly or through the work table. For best results always clamp the work lead directly to the material being welded, otherwise a poor electrical circuit may create itself.

MIG/MAG process features and benefits

Terms used: MIG - Metal Inert Gas Welding
MAG - Metal Active Gas Welding
GMAW - Gas Metal Arc Welding

MIG welding was developed to help meet production demands of the war and post war economy which is an arc welding process in which a continuous solid wire electrode is fed through a MIG welding gun and into the weld pool, joining the two base materials together. A shielding gas is also sent through the MIG welding gun and protects the weld pool from contamination which also enhances the arc.

The MIG/MAG process can be used to weld a wide variety of materials and is normally used in the horizontal position but can be used in vertical or overhead with the correct selection of machine, wires and current. In addition, it can be used to weld at long distances from the power source subject to the correct cable sizing.

It is the dominant process used in maintenance and repair industries and is used extensively in structural and fabrication work.

Weld quality is also highly dependent on the skill of the operator and many welding problems can exist due to incorrect installation application and use.

Welding position

When welding, ensure you place yourself in a comfortable position for welding and your welding application before you begin to weld. This maybe by sitting at a suitable height which often is the best way to weld ensuring you're relaxed and not tense. A relaxed posture will ensure the welding task becomes much easier.

Please ensure you always wear suitable PPE and use suitable fume extraction when welding.

Place the work so that the direction of welding is across, rather than to or from your body.

The electrode holder lead should always be clear of any obstruction so that you can move your arm freely along as the electrode burns down. Some elders prefer to have the welding lead over their shoulder, this allows greater freedom of movement and can reduce the weight from your hand.

Always inspect your welding equipment, welding cables and electrode holder before each use to ensure it is not faulty or worn as you may be at risk of an electric shock.

GUIDE TO MIG/MAG WELDING



Before starting any welding activity ensure that you have suitable eye protection and protective clothing. Also take the necessary steps to protect any persons within the welding area.

MIG controls

The main basic controls for the MIG/MAG system are wire feed speed and voltage.

Wire feed speed

The wire speed is directly related to the current. The higher the wire speed the more wire is deposited and hence more current is required to burn off the consumable wire.

Wire speed is measured in m/min (metres per min) or sometimes in ipm (inches per minute).

The diameter of the wire also forms part of the current demand e.g. a 1.0mm wire feeding at 3m per minute will require less current than a 1.2mm wire feeding at the same rate.

The wire feed is set according to the material to be welded.

If the wire feed rate is too high in comparison to the voltage then a “stubbing” effect happens where un-melted consumable contacts the work piece creating large amounts of weld spatter.

Too little wire feed comparison to the voltage will result in a long arc being created with poor transfer and eventual burning back of the welding wire onto the contact tip.

Please Note: The EVO MIG machines top displays defaults are wire feed speed and will then show amperage when welding commences.

Voltage setting

The voltage polarity in MIG/MAG welding is in the majority of cases with the positive (+). This means that the majority of the heat is in the electrode wire.

Certain special wires may require the polarity to be reversed i.e. electrode wire negative (-) polarity. Always consult the manufacturer's data sheet for the best operating parameters.

The voltage is often referred to as the “heat setting”. This will be altered dependent on the material type, thickness, gas type, joint type and position of the weld. Combined with the wire speed it is the main control adjusted by the welder. The voltage setting varies depending on the type and size of electrode wire being used.

Most MIG/MAG welders are CV (Constant Voltage) power sources which means the voltage does not vary much during welding. Modern inverter power sources also have control circuits to monitor conditions to ensure voltage remains constant.

The voltage determines height and width of the weld bead. If the operator has no reference to settings required the best method of set up is to use scrap material of the same thickness to obtain the correct setting. If there is too much voltage the arc will be long and uncontrollable and cause the wire to fuse to the contact tip. If the voltage is too low then there will not be enough heat to melt the wire and then stubbing occurs.

To obtain a satisfactory weld, a balance needs to be made between voltage and wire speed.

Characteristics of the voltage are that the higher voltage produces a flatter and wider weld bead but care must be taken to avoid undercut. The lower the voltage the weld bead becomes narrow and higher.



Wire Speed Feed

Welding Voltage

GUIDE TO MIG/MAG WELDING



Before starting any welding activity ensure that you have suitable eye protection and protective clothing. Also take the necessary steps to protect any persons within the welding area.

Modes of Transfer

Dip or short circuit mode

In the dip or short circuit, the wire (electrode) touches the work piece and a short circuit is created. The wire will short circuit the base metal between 90 and 200 times per second. This method has the benefit of creating a small, quickly solidifying weld puddle. The deposition rates, wire speed and voltages are usually lower than other modes of transfer and the low heat input makes it a flexible mode for both thick and thin metals in all positions.

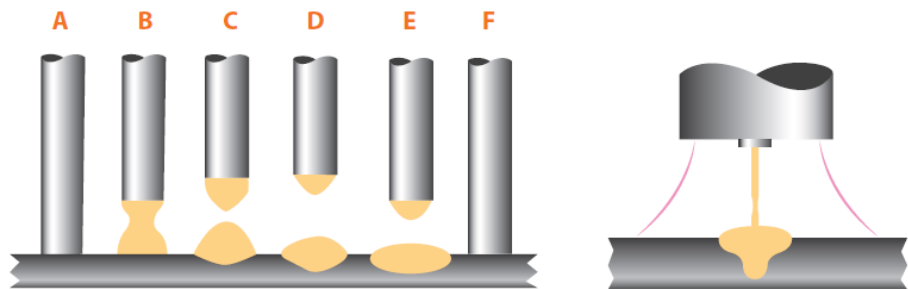

- A - Consumable wire feed to work piece and short circuit is created
- B - Wire starts to melt due to short circuit current
- C - Wire pinches off
- D - Arc length opens due to burn off
- E - Wire advances towards the work piece
- F - Wire short circuits and the process cycles again

Some of the disadvantages of this method are limited wire feed speed and hence weld deposition rates. On thicker material there can also be a danger of “cold lapping” occurring. This occurs when there is not enough energy in the weld puddle to fuse properly.

Another disadvantage is that this mode produces an increased amount of spatter due to the short circuits especially compared to the other transfer methods.

An inductance is used to control the surge in current when the wire dips into the weld pool.

Modern electronic power sources can automatically set the inductance to give a smooth arc and metal transfer.

Globular Transfer Mode

The globular transfer method is in effect an uncontrolled short circuit which occurs when the voltage and wire are above the dip range but too low for spray. Large irregular globules of metal are transferred between the torch and work piece under the force of gravity.

The disadvantages of this method of transfer are that it produces a large amount of spatter as well as high heat input. In addition, globular transfer is limited to flat and horizontal fillet welds above 3mm. Lack of fusion is often common because the spatter disrupts the weld puddle. Also, because globular transfer uses more wire it is generally considered less efficient.

The advantages of globular transfer are that it runs at high wire feed speeds and amperages for good penetration on thick metals. Also, when weld appearance is not critical it can be used with inexpensive, CO₂ shielding gas.

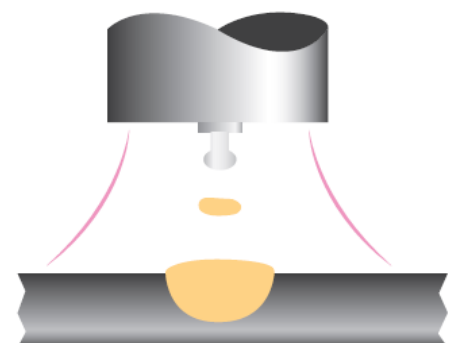

GUIDE TO MIG/MAG WELDING



Before starting any welding activity ensure that you have suitable eye protection and protective clothing. Also take the necessary steps to protect any persons within the welding area.

Modes of Transfer

Spray Arc Mode

The Spray arc mode is used with high voltage and current. Metal is projected in the form of a fine spray of molten droplets of the electrode, propelled across the arc to the work piece by an electromagnetic force without the wire touching the weld pool.

Its advantages include high deposition rates, good penetration, strong fusion, excellent weld appearance with little spatter as no short circuits are occurring.

The disadvantages of the spray arc mode are mainly due to the high heat input which can cause problems on thinner material and the limited range of welding positions where the mode can be used. Generally, the minimum thickness to be welded will be around 6mm.

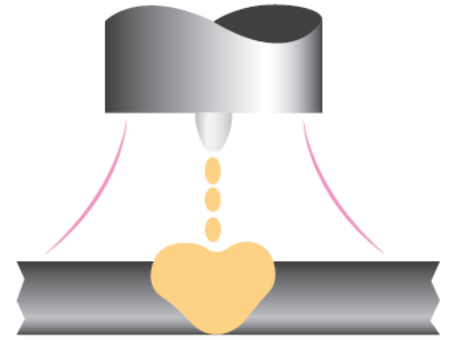

Pulsed Arc Mode

Pulsed MIG is an advanced form of welding that takes the best of all the other forms of transfer while minimizing or eliminating their disadvantages.

Unlike short circuit, pulsed MIG does not create spatter or run the risk of cold lapping. The welding positions in pulsed MIG are not limited as they are with globular or spray and its wire use is definitely more efficient. By cooling off the spray arc process, pulsed MIG is able to expand its welding range and its lower heat input does not encounter the problems on thinner materials.

In basic terms, pulsed MIG is a transfer method where material is transferred between the electrode and the weld puddle in controlled droplet form. This is achieved by controlling the electrical output of the welding machine using the latest control technologies.

The pulsed MIG process works by forming one droplet of molten metal at the end of the wire electrode per pulse. When ready the pulse of current is used to propel that one droplet across the arc and into the puddle.

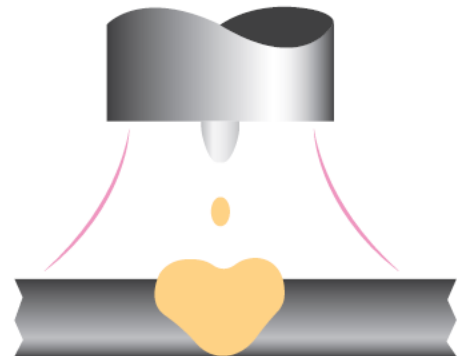

Welding Mode - Synergic

When a welding machine is referred to as synergic it means that when a single setting is adjusted (most commonly voltage or material thickness) other settings like current or wire speed also change.

There are current and voltage settings for all wire types, wire diameters and shielding gases.

The same current settings will have different wire feed speeds, workpiece material thickness and synergic voltages for different wire diameters.

After setting the current or wire feed speed and workpiece thickness, the system will have predetermined settings via it's software to match the welding voltage and the other welding parameters.

After choosing "synergic", the machine panel's left display will show preset current (wire feed speed or workpiece thickness dependent on the parameter selected). The right display will show the preset voltage.

The wire feeder control panel left display will show preset current and right display will show preset arc length. Both wire feed unit controls can both set current and voltage. Standard arc length is "0"; adjustment is based on the synergic voltage plus or minus 3.0V.

GUIDE TO MIG/MAG WELDING



Before starting any welding activity ensure that you have suitable eye protection and protective clothing. Also take the necessary steps to protect any persons within the welding area.

Welding Mode - Standard

Current or wire feed speed, workpiece thickness adjustment has no relation with voltage adjustment and other parameters. In this modes all required parameters are to be set as separate settings. Please see wire speed and voltage setting above.

Some quick reference handy tips for the MIG/MAG welding process are:

- When welding, try to use an electrode stick out (the distance between the weld and the contact tip) of around 6-8mm
- When welding thin materials try and use smaller MIG wire diameters and for thicker materials use thicker wires
- Make sure you select the correct MIG wire type for the material to be welded
- Ensure the MIG welding gun has the correct sized contact tip and type of liner
- Always ensure you have the correct size drive rolls and torch liner for the wire size selected
- Select the correct gas to achieve the correct weld characteristics and finish
- For optimum control of the weld keep the wire at the leading edge of the weld pool
- Before commencing welding, ensure a comfortable and stable position
- Try to keep the welding torch as straight as possible when welding to ensure the best feed
- Carry out daily housekeeping on the condition of the welding torch and drive rolls
- Keep any consumables clean and dry to avoid contamination such as oxidation and damp

Inductance

When MIG/MAG welding in the dip transfer mode the welding wire electrode touches the work piece/ weld pool and this results in a short circuit. When this short circuit occurs the arc voltage will fall to nearly zero. This change in the arc voltage will cause a change in the welding circuit.

The fall in voltage will cause a rise in the welding current. The size of the current rise is dependent upon the welding characteristic of the power source.

Should the power source respond immediately then the current in the circuit would rise to a very high value. The rapid increase in current would cause the short circuited welding wire to melt similar to an explosion creating a large amount of molten weld spatter.

By adding inductance to the weld circuit this will slow down the rate of current rise. It works by creating a magnetic field which opposes the welding current in the short circuit thereby slowing the rate of rise. If the inductance is increased it will cause an increase in arc time and reduction in the dip frequency, this will help reduce spatter.

Depending on the welding parameters there will be an optimum inductance setting for the best welding conditions. If the inductance is too low then there will be excessive spatter. If the inductance is too high the current will not rise high enough and the wire will stab the weld pool with insufficient heat.

The modern technology welding power sources often have the ability to provide the correct inductance to provide excellent weld characteristics. Many have a variable inductance control to give precise control.

GUIDE TO MIG/MAG WELDING



Before starting any welding activity ensure that you have suitable eye protection and protective clothing. Also take the necessary steps to protect any persons within the welding area.

Burn Back

In the event that the welder was to stop welding and all functions of the machine stopped simultaneously then the consumable filler wire would in all likelihood freeze in the weld pool. In order to avoid this happening the burn back feature is present on most machines.

This facility may be built in or an adjustable control. It will allow the power and gas shield to be maintained on the consumable filler wire when it has stopped feeding thereby burning clear of the weld. In some equipment the burn back is preset within the control circuits others offer an external variable control feature to adjust the time of delay.

Other Controls

Other common control features are latching or 2T/4T where the welding can either in 2T mode press the torch trigger to weld and release to stop or in 4T press and release the torch trigger to start, weld without holding the trigger on and stop by pressing and releasing the trigger again. This is particularly useful when welding long weld runs.

Crater fill controls are available on many machines. This allows the crater at the end to be filled helping eliminate welding defects.

A spot welding timer will allow the time of the weld to be set and after the time has expired the operator will have to release the torch switch to restart the weld.

MIG/MAG system checks

Shielding gas nozzle

This nozzle must be periodically cleaned to remove weld spatter. Replace if distorted or squashed.

Contact Tip

Only a good contact between this contact tip and the wire can ensure a stable arc and optimum current output; you must therefore observe the following precautions:

- The contact tip hole must be kept free of grime and oxidation (rust).
- Weld spatter sticks more easily after long welding sessions, blocking the wire flow, the tip must therefore be cleaned often and replaced if necessary.
- The contact tip must always be firmly screwed onto the torch body. The thermal cycles to which the torch is subjected can cause it to loosen, thus heating the torch body and tip and causing the wire to advance unevenly.

MIG Torch Wire Liner

This is an important part that must be checked often because the wire may deposit copper dust or tiny shavings. Clean it periodically along with the gas lines using dry compressed air. The liners are subjected to constant wear and tear and therefore must be replaced after a certain amount of time.

Wire Drive System

Periodically clean the set of feeder rollers to remove any rust or metal residue left by the coils. You must periodically check the entire wire feeder group: feed arms, wire guide rollers, liner and contact tip.

SPOOL GUN OPERATION



Before starting any welding activity ensure that you have suitable eye protection and protective clothing. Also take the necessary steps to protect any persons within the welding area.

Spool Gun Welding Mode

Spool gun part number is JE-SP250-6

The Jasic EVO EM-200CT & EM-250CT machines can both be used with our optional spool gun which is a Euro style spool gun that connects to the EVO MIG machines via the Euro outlet connector.

Connect the spool gun Euro plug to the (MIG) euro socket. Connect the spool gun 9 pin control plug to its matching 9 pin socket located on the front panel of the machine.

Ensure the trailing lead is connected into the “+” socket on the front panel of the machine and tighten clockwise.

Insert the cable plug for the work clamp into the “-” socket on the front panel of the welding machine and tighten clockwise.

Connect the gas hose to the regulator/flowmeter located on the shield gas cylinder and connect the other end to the machine.

Before starting any welding activity ensure that you have suitable eye protection and protective clothing. Also take the necessary steps to protect any persons within the area.

After connecting the welding leads as detailed above you will need to switch the power switch on the back panel to “ON”, select MIG welding mode ‘A’ and spool gun mode ‘B’. Set the welding voltage and other parameters via the machine control panel. When the remote control function is enabled, the "Wire Feed Speed" is adjusted by the potentiometer on the spool torch handle.

Ensure you have adequate welding current according to the thickness of the work and weld prep being carried out.

Fit your 1Kg reel of welding wire to the spool holder and feed the wire through the drive rolls ensuring the fitted roller sizes matches your wire type and size, then continue to feed the wire through the contact tip again ensuring you have the correct size tip fitted.

Open the gas valve of the cylinder, press the torch trigger and adjust the gas regulator to obtain the desired flow rate.

Pressing the spool gun torch trigger will start the machine and welding can now be carried out.

Adjust the “voltage” control knob on the front panel of the machine to set the correct welding voltage and adjust the “wire feed speed” control knob either on the spool gun.

Please Note:

- The spool gun option can only be used in standard MIG welding mode, all other functions work as standard MIG torch. Spool gun part number is JE-SP250-6.
- MIG Synergic function is disabled when the control panel is set to spool gun. If there is no wire feed potentiometer built into the spool torch and Spool gun is selected and remote control function is enabled, then welding current will not be able to be adjusted.

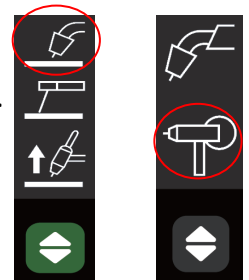

MIG Set-Up Guide

Please Note: This information is intended to act as a starting point guide only for standard MIG mode

Set-Up Guide

Note:
 * This set-up information is intended to act as a guide only. Please refer to user manual for further information.
 * The data in this sheet are based on fillet welding.
 * Multi-pass welding shall be used for plates over 10mm.



Ver.1.0

DCEP
(Electrode Positive)

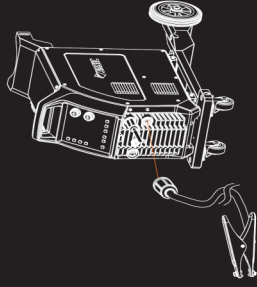

DCEN
(Electrode Negative)

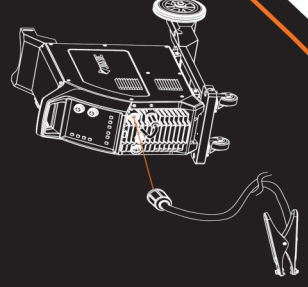

Material	Wire Type	Polarity	Shielding Gas (20-30 CFH Flow Rate)	Wire Dia. (mm)	115 & 230VAC										230VAC			Thickness (mm)	WFS Volts	V (mm/min)										
					0.5	0.6	0.8	1.0	1.2	1.5	2.0	2.5	3.0	4.0	5.0	6.0	8.0				10.0									
Steel	Steel ER70S-6	DCEP	Ar80% CO ₂ 20%	0.6	5.1	5.3	7.1	9.1	10.8	13.6	15.6	17.0	—	—	—	—	—	—	—	—	—	—	—	—	—					
				15.0	15.2	15.8	17.3	18.5	20.3	21.5	22.4	—	—	—	—	—	—	—	—	—	—	—	—	—	—	—	—			
				2.8	3.7	4.5	6.3	7.9	8.2	9.0	10.2	12.6	15.4	17.2	18.0	—	—	—	—	—	—	—	—	—	—	—	—	—		
				15.3	16.0	16.6	17.4	17.8	17.9	18.1	18.5	17.9	23.2	25.5	30.0	—	—	—	—	—	—	—	—	—	—	—	—	—	—	
				—	2.1	2.4	3.5	5.1	6.3	7.5	8.3	8.6	10.0	11.2	12.0	12.8	24.1	26.3	28.1	—	—	—	—	—	—	—	—	—	—	
	Steel	FluxCored E711-Q	DCEP	Ar80% CO ₂ 20%	0.6	4.0	4.5	6.8	9.0	10.5	13.0	14.5	16.4	—	—	—	—	—	—	—	—	—	—	—	—	—	—			
					16.8	17.0	17.1	17.7	18.5	19.1	20.0	20.6	21.8	—	—	—	—	—	—	—	—	—	—	—	—	—	—	—		
					3.0	3.9	4.6	6.4	8.0	8.3	9.2	10.5	12.8	15.0	17.8	18.0	—	—	—	—	—	—	—	—	—	—	—	—	—	
					16.5	17.2	17.7	18.9	19.9	20.1	20.9	22.0	23.9	25.4	26.0	26.6	—	—	—	—	—	—	—	—	—	—	—	—	—	—
					—	2.2	2.5	3.5	5.1	6.6	7.8	8.8	9.1	9.6	10.2	10.7	11.8	26.9	27.7	29.7	—	—	—	—	—	—	—	—	—	—
Steel	Steel FCW-SS E711-GS	DCEN	Ar80% CO ₂ 20%	0.8	—	—	5.8	8.6	12.0	13.5	13.8	14.5	15.4	—	—	—	—	—	—	—	—	—	—	—	—	—				
				15.8	16.2	17.3	21.4	22.5	22.7	23.3	24.1	25.5	—	—	—	—	—	—	—	—	—	—	—	—	—	—	—			
				3.2	3.7	4.5	5.7	6.9	7.6	8.1	8.9	9.8	10.8	12.3	14.6	16.6	25.8	26.9	—	—	—	—	—	—	—	—	—	—		
				16.5	16.9	18.0	19.3	19.7	20.0	20.5	21.5	23.4	25.8	28.9	—	—	—	—	—	—	—	—	—	—	—	—	—	—	—	
				—	7.0	7.8	9.9	13.5	14.8	15.0	15.3	15.9	17.7	—	—	—	—	—	—	—	—	—	—	—	—	—	—	—	—	
				—	18.2	18.7	20.0	22.9	23.4	23.5	23.7	24.0	25.7	—	—	—	—	—	—	—	—	—	—	—	—	—	—	—	—	
Stainless Steel	CrNi ER308	DCEP	Ar98% CO ₂ 2%	0.8	—	—	3.2	3.9	4.9	5.7	6.2	6.7	7.7	9.2	10.7	12.0	15.5	17.5	—	—	—	—	—	—	—	—				
				15.9	16.3	16.8	17.0	17.2	17.4	17.9	18.7	19.4	20.0	21.6	22.4	—	—	—	—	—	—	—	—	—	—	—	—			
				2.1	2.6	3.1	3.4	3.8	4.2	4.7	5.2	5.8	6.5	7.1	7.8	10.5	11.9	13.8	14.6	—	—	—	—	—	—	—	—			
				16.8	16.9	17.0	17.1	17.2	17.4	17.5	17.8	18.4	19.1	19.6	20.0	21.9	—	—	—	—	—	—	—	—	—	—	—	—		
Aluminum	AlMg ER5356	DCEP	Ar100%	1.0	—	—	5.4	9.3	9.2	10.3	11.1	12.3	13.5	14.5	15.4	16.4	17.5	—	—	—	—	—	—	—	—	—				
				13.2	13.6	16.1	17.2	17.2	17.4	17.7	20.4	23.1	25.4	26.7	27.2	27.8	—	—	—	—	—	—	—	—	—	—	—			
				—	—	2.3	3.6	5.4	7.2	8.7	9.6	10.1	10.7	11.3	12.5	13.8	14.6	—	—	—	—	—	—	—	—	—	—	—		
				—	—	14.2	14.9	15.8	19.7	23.9	26.4	27.1	27.4	28.5	29.3	—	—	—	—	—	—	—	—	—	—	—	—	—		
Aluminum	AlMg ER5356	DCEP	Ar100%	1.0	—	—	5.6	6.9	7.9	9.3	10.8	11.5	12.8	14.3	15.1	16.2	17.3	18.0	—	—	—	—	—	—	—	—				
				14.8	15.1	15.3	15.7	16.2	16.7	17.8	19.1	19.9	20.9	21.9	22.5	—	—	—	—	—	—	—	—	—	—	—	—			
Aluminum	AlMg ER5356	DCEP	Ar100%	1.2	—	—	4.0	5.6	6.9	8.6	9.6	10.8	11.5	12.8	14.3	15.1	16.2	17.3	18.0	—	—	—	—	—	—	—				
				—	—	—	4.0	5.6	6.9	8.6	9.6	10.8	11.5	12.8	14.3	15.1	16.2	17.3	18.0	—	—	—	—	—	—	—	—			

MIG WELDING PROBLEMS



Before starting any welding activity ensure that you have suitable eye protection and protective clothing. Also take the necessary steps to protect any persons within the welding area.

MIG welding defects and prevention methods

<u>Defect</u>	<u>Possible cause</u>	<u>Action</u>
Porosity (within or outside the bead)	Poor material	Check the material is clean
	Insufficient shield gas flow	Check hoses and MIG torch for blockages
	Gas flow too low/high	Check the regulator setting or that it is not frozen due to a high flow
	Leaking hoses	Check all hoses for leaks
	Faulty gas valve	Call a service engineer
	Working in open area with drafts	Put screens up around the weld area
Poor or inconsistent wire feed	Incorrect pressure on wire drive causing burn back to contact tip or bird nesting at the feed roll	Readjust the upper feed pressure Increase the pressure to eliminate burn back to tip Decrease pressure to eliminate bird nesting
	Damage to torch liner	Replace torch liner
	Welding wire contaminated or rusty	Replace wire
	Worn welding tip	Check and replace welding tip
No operation when the torch switch is operated	Torch switch faulty	Check the torch switch continuity and replace if faulty
	Fuse blown	Check fuses and replace if necessary
	Faulty PCB inside the equipment	Call a service engineer
Low output current	Loose or defective work clamp	Tighten/replace clamp
	Loose cable plug	Re-fix plug
	Power source faulty	Call a service engineer
No operation	No operation and mains lamp not lit	Check mains fuse and replace if required
	Faulty power source	Call a service engineer
Excessive spatter	Wire feed speed too high or welding voltage too low	Reset the parameters according to the weld to be made
Excessive penetration, the weld metal is below the surface level of the material and hangs below	Heat input too high	Reduce the amperage or use a smaller electrode and lower amperage
	Poor weld technique	Use correct welding travel speed

MIG WELDING PROBLEMS



Before starting any welding activity ensure that you have suitable eye protection and protective clothing. Also take the necessary steps to protect any persons within the welding area.

MIG welding defects and prevention methods

<u>Defect</u>	<u>Possible cause</u>	<u>Action</u>
Burning through – Holes within the material where no weld exists	Heat input too high	Use lower amperage or smaller electrode Use correct welding travel speed
Poor fusion – Failing of weld material to fuse either with the material to be welded or previous weld beads	Insufficient heat level	Increase the amperage or increase the electrode size and amperage
	Poor welding technique	Joint design must allow for full access to the root of the weld Alter welding technique to ensure penetration such as weaving, arc positioning or stringer bead technique
	Work piece dirty	Remove all contaminant from the material i.e. oil, grease, rust, moisture prior to welding
Irregular weld bead and shape	Incorrect voltage/wire feed settings If it's convex, voltage is too low and if it's concave then voltage is too high.	Adjust voltage and/or wire feed speed
	Insufficient or excessive heat input	Adjust the wire feed speed dial or the voltage control
	Wire is wandering	Replace contact tip
	Incorrect shielding gas	Check and change the shielding gas as required
Your weld is cracking	The weld beads too small	Try decreasing the travel speed
	Weld penetration narrow and deep	Try reducing the wire feed speed current and voltage or increase MIG torch travel speed
	Excessive voltage	Decrease voltage control dial
	Weld/material cooling rate too fast	Slow the cooling rate by preheating part to be welded or cool slowly
The welding arc does not have a crisp sound that short arc exhibits when the wire feed speed or voltage are adjusted correctly.	The MIG torch may have been connected to the wrong output voltage polarity on the front panel	Ensure that the MIG torch polarity lead is connected to the positive (+) welding terminal for solid wires and gas shielded flux cored wires

EM-200C PFC MIG TORCH SPARE PARTS LIST

MIG Welding Torch Air Cooled - Model: JE250-3

T250 Rating 230A Co2 / 200A Mixed Gases @ 60% Duty Cycle EN60974-7 Wire Size 0.8mm to 1.2mm



Torch Packages

JE250-3 3 metre
JE-250-4 4 metre
JE-250-5 5 metre

*Euro Fitting and Bladeswitch

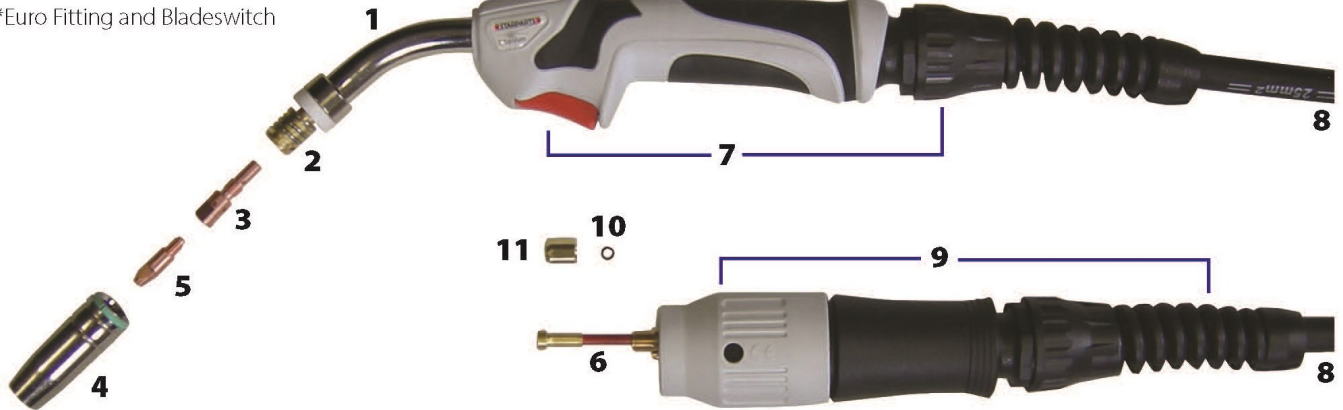

Main Consumables

Code	Description	Pack Qty
1	SP2554 Swan Neck Complete	1
2	SP2557 Shroud Spring	10
3	SP2581 Tip Adaptor M6 Tips	5
	SP2582 * Tip Adaptor M8 Tips	5
4	SP2570 Nozzle Conical	5
	SP2571 Nozzle Cylindrical	5
	SP2572 Nozzle Tapered	5
	SP2574 Spot Welding Nozzle	5

Contact Tips (ECU M6 x 28mm)

5	SP2408 0.8mm Steel / 0.6mm Alum Wire	25
	SP2409 0.9mm Steel Wire	25
	SP2410 1.0mm Steel / 0.8mm Alum Wire	25
	SP2412 1.2mm Steel / 1.0mm Alum Wire	25

* For specifically marked ALU Tips add 'A' after the part number eg: SP2410A

Contact Tips (CuCrZr M6 x 28mm)

	SP2508 0.8mm Steel / 0.6mm Alum Wire	25
	SP2509 0.9mm Steel Wire	25
	SP2510 1.0mm Steel / 0.8mm Alum Wire	25
	SP2512 1.2mm Steel / 1.0mm Alum Wire	25

Liners (Steel Plastic Coated)

Code	Description	Pack Qty
6	SP1539 0.6 - 0.9mm x 3m - P.C Blue	1
	SP1549 0.6 - 0.9mm x 4m - P.C Blue	1
	SP1559 0.6 - 0.9mm x 5m - P.C Blue	1
	SP2432 1.0 - 1.2mm x 3m - P.C Red	1
	SP2442 1.0 - 1.2mm x 4m - P.C Red	1
	SP2452 1.0 - 1.2mm x 5m - P.C Red	1

Liners (PTFE)

	SP1538T 0.6 - 0.8mm x 3m - P.C Blue	1
	SP1548T 0.6 - 0.8mm x 4m - P.C Blue	1
	SP1558T 0.6 - 0.8mm x 5m - P.C Blue	1
	SP2432T 1.0 - 1.2mm x 3m - P.C Red	1
	SP2442T 1.0 - 1.2mm x 4m - P.C Red	1
	SP2452T 1.0 - 1.2mm x 5m - P.C Red	1
	SP1511 Liner Collet	5
	SP1517 Liner 'O' Ring	10

Secondary Consumables

7	Complete Bladeswitch Handle c/w Cable Support	1
8	SP2403 Cable Assy 3m	1
	SP2404 Cable Assy 4m	1
	SP2405 Cable Assy 5m	1
9	SP8003 Complete Euro Connection Kit c/w Support	1
10	SP1596 Gun Plug 'O' Ring	10
11	SP1597 Liner Retaining Nut	5

* For 8mm Threaded Tips Use SP38 / SP40 Series See Page 194 Item No. 6

Please Note: Package contents may vary depending on country location and package part number purchased

PLEASE NOTE:

Check torch supplied with your package to ensure it matches the above details. The product maybe supplied with a Jasic orange torch handle.

MMA SETUP

Output connections

Electrode polarity is generally determined by the type of welding rod being used although in general when using manual arc welding electrodes the electrode holder is connected to the positive terminal and the work return to the negative terminal.

Generally, there are two connection methods of DC welder: DCEN and DCEP connection.

DCEN: The welding electrode holder is connected to the negative polarity, and the workpiece is connected to the positive polarity.

DCEP: The electrode holder is connected to the positive polarity, and the workpiece is connected to the negative polarity (as example shows below).

The operator can choose DCEN based on the base metal and welding electrode. Generally speaking, DCEP is recommended for basic electrodes (i.e. electrode connected to the positive polarity).

Please Note:

Always consult the electrode manufacturer's data sheet if you have any doubts.

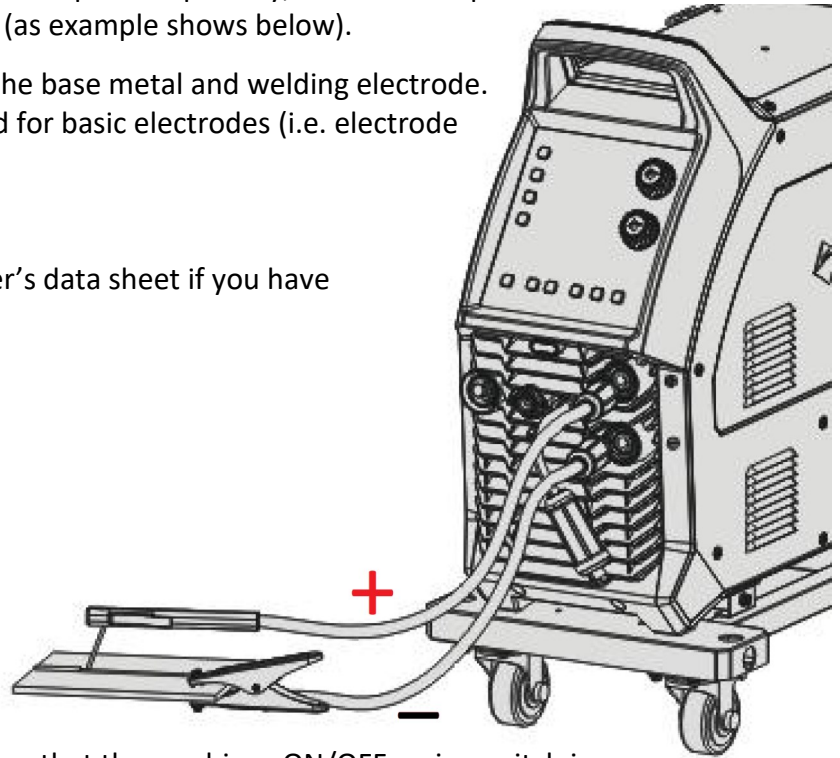

MMA welding

1. When connecting welding cables, ensure that the machine's ON/OFF mains switch is turned off and never connect the machine to the mains supply with the panels removed.
2. Insert the cable plug with electrode holder into the "+" socket on the front panel of the welding machine and tighten it clockwise.
3. Insert the cable plug of the work return lead into the "-" socket on the front panel of the welding machine and tighten it clockwise.

If you want to use long secondary cables (Electrode holder cable and/or earth cable), you must ensure that the cross-sectional area of the cable is increased appropriately in order to reduce the voltage drop due to the cable length.

Please Note:

Check these power connections daily to ensure they have not become loose otherwise arcing may occur when used under load.

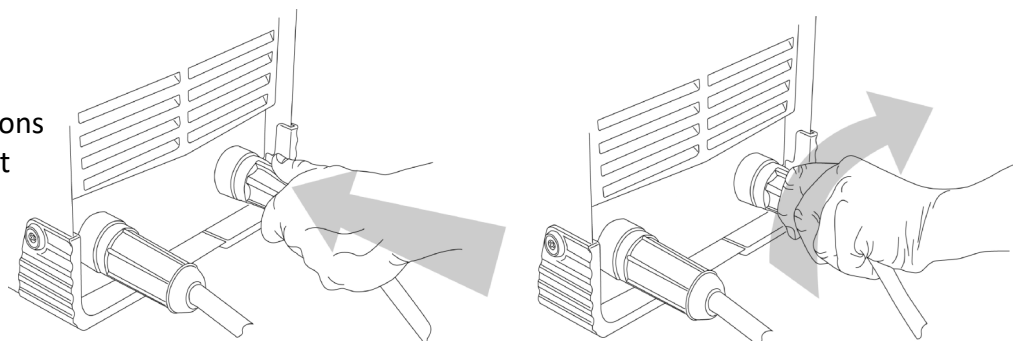

Generic library picture

OPERATION - MMA



Before starting any welding activity ensure that you have suitable eye protection and protective clothing. Also take the necessary steps to protect any persons within the welding area.

MMA welding

MMA (Manual Metal Arc), SMAW (Shielded Metal Arc Welding) or just Stick Welding. Stick welding is an arc welding process which melts and joins metals by heating them with an arc between a covered metal electrode and the work.

Shielding is obtained from the electrode outer coating, often called flux. Filler metal is primarily obtained from the electrode core.

The electrodes outer coating called flux assists in creating the arc and provides a shielding gas and on cooling forms a slag covering to protect the weld from contamination.

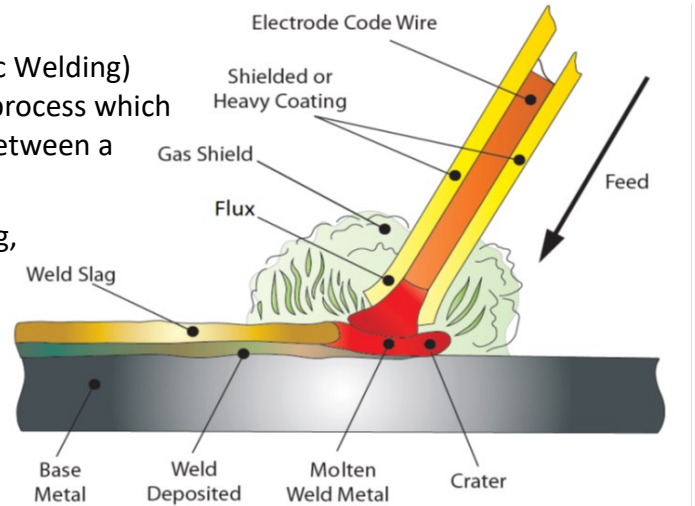

When the electrode is moved along the work piece at the correct speed the metal core deposits a uniformed layer called the weld bead.

After connecting the welding leads as detailed above, plug your machine into the mains supply and turn 'ON' the machine, the power switch is located at the rear panel of the machine, place it to the "ON" position, the panel indicator will then light up, the fan may start to rotate as the welding machine powers up and the control panel will also light up to indicate that the machine is ready to use as shown below.



PLEASE NOTE:

Caution, there is welding voltage at both output terminals.



Some welding models are equipped with the smart fan function. When the power supply is turned on after a period before welding starts, the fan will automatically stop running. The fan will then run automatically when welding begins.

Now you can connect the welding leads as shown in the image below, ensure you check that you have the electrode polarity correct to match the welding rod being used.

In the image left, you will note that MMA has been selected (in red) and that the MMA parameter for current control has been selected and MMA current is adjusted via the control dial and has been set to 130 amps which is previewed on the display.

You will note that the remote control option is turned off, so in this case current control is via the control panel dial. Pressing the remote control button will allow the operator to use remote control accessory, see page 18 for further information.

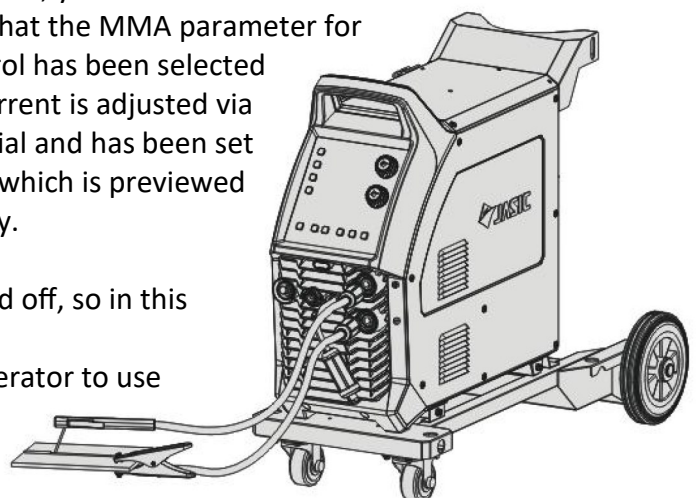

OPERATION - MMA



Before starting any welding activity ensure that you have suitable eye protection and protective clothing as, welding rays, spatter, smoke and high temperatures produced in the process may cause injury to personnel.

Also take the necessary steps to protect any persons within the welding area that may cause injury too.

MMA welding

Select MMA welding mode by pressing the green arrow button until the MMA symbol is illuminate as shown in the image right (circled red).

When in MMA mode you can select and adjust welding current, hot start current and arc force parameters respectively as described below.

MMA Welding Current Adjustment

MMA current adjustment can now be carried out via the panel control current adjustment dial and this can be achieved by rotating the top encoder dial 'A' (as shown right) either clockwise or anticlockwise which will increase or decrease the welding amperage shown on the current display along side the dial.

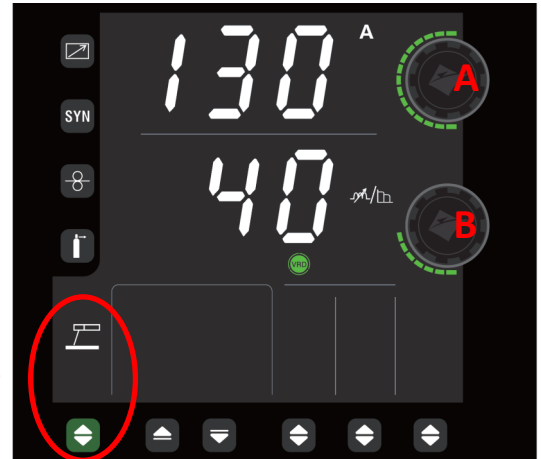

Please Note: Welding current adjustment can be carried out during welding.

Arc Force Current Adjustment

By default the bottom display will show the MMA voltage (see image on page 51).

To select MMA arc force, press the lower encoder button 'B' (as shown above) until the arc force icon  illuminates, you will now note that MMA voltage has been replaced on the lower display by the arc force current details.

You can now rotate the control dial 'B' clockwise or anticlockwise which will increase or decrease the required arc force current until the desired arc force current is shown on the display. In our example above 40A has been selected.

Hot Start Current Adjustment

The hot start current value is factory preset to 30A although can be adjusted within the engineers mode back ground settings between the range of 0 ~ 60Amps.

See pages 25/26 for further details on adjusting the hot start current value.

VRD indicator



In MMA mode, the VRD LED will be lit to indicate that VRD is active and the machine output voltage is 10.9V (see page 24 for further details).

The table right offers a current guide for various sizes of welding electrode diameters versus recommended current ranges.

The operator can set their own parameters based on the type and diameter of welding electrode and their own process requirements.

PLEASE NOTE:

- The operator should set the parameters that meet the welding requirements.
- If the selections are incorrect this may lead to problems such as an unstable arc, spatter or sticking of the welding electrode to the work piece.
- If the secondary cables (welding cable and earth cable) are long, select cable with larger cross-section to reduce the voltage drop.

Electrode Size (mm)	Recommended Welding Current (A)
1.0	20 ~ 60
1.6	44 ~ 84
2.0	60 ~ 100
2.5	80 ~ 120
3.2	108 ~ 148
4.0	140 ~ 180

OPERATION - MMA



Before starting any welding activity ensure that you have suitable eye protection and protective clothing as, welding rays, spatter, smoke and high temperatures produced in the process may cause injury to personnel.

Also take the necessary steps to protect any persons within the welding area that may cause injury.

MMA welding

Arc force:

Arc force prevents the electrode sticking when welding. Arc force provides a temporary increase in current when the arc is too short and helps maintain consistent excellent arc performance on a wide range of electrodes. The Arc force value should be determined according to welding electrode diameter, current setting, and process requirements.

High arc force settings lead to a crisper, higher penetration arc but with some spatter.

Lower arc force settings provide a smooth arc with lower spatter and a good weld seam formation, but sometimes the arc is soft or the welding electrode can stick.

Hot start current: The EM-200CT and EM-250CT hot start is factory preset to 30A although adjustable in the back ground settings from 0 ~ 60amps, see pages 25/26 for further information).

The hot start current is an increase in welding current at the start of the weld to give excellent arc ignition and to avoid the electrode sticking. It also can reduce weld defects at the start of the weld.

The magnitude of hot start current is generally determined based on the type, specification, and welding current of welding electrode.

During DC welding the heat on the positive and negative electrodes of the welding arc is different. When welding using DC power supply, there are DCEN (DC electrode negative) and DCEP (DC electrode positive) connections. The DCEN connection refers to the welding electrode connected to the negative electrode of the power supply and the work piece connected to the positive electrode of the power supply.

In this mode the work piece receives more heat, resulting in high temperature, deep molten pool, easy to weld through, suitable for welding thick parts. The DCEP connection refers to the welding electrode connected to the positive power supply with the work piece connected to the negative power supply.

In this mode the work piece receives less heat, resulting in low temperature, shallow pool, and difficulty in welding through. This is suitable for welding thin parts.

During welding:

PLEASE NOTE: The EM-200CT and EM-250CT units have preset anti-stick function by default.

In the welding process, if a short circuit occurs on the welding output for 2 seconds, the machine will automatically enter anti-stick mode. This means the welding current will automatically drop to 20A to allow the short circuit to be cleared. When the short circuit is cleared the welding current will automatically return to the set current.

Turn off the power supply after welding

On completion of any welding operating, the machine should be powered down. The power switch is located on the rear panel of the machine and should be set to the "off" position.

It maybe noted that for a short period of time that the machine fan continues to run, this is quite normal and after a short time delay, the control panel lights indicator will turn off and the fan will stop indicating that the welder has now fully down.

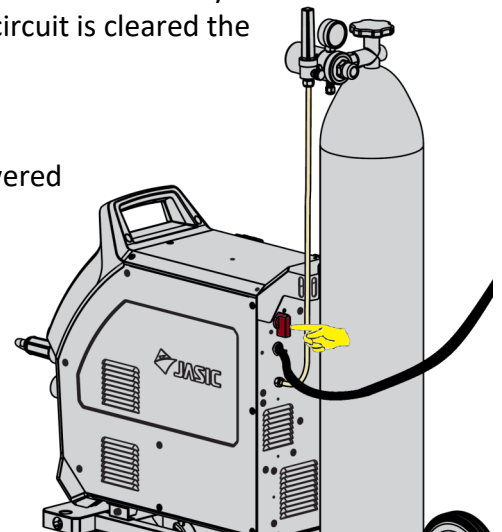

GUIDE TO MMA WELDING



Before starting any welding activity ensure that you have suitable eye protection and protective clothing.

Also take the necessary steps to protect any persons within the welding area.

MMA process tips and guides

Typical welder set up

1. Electrode holder
2. Work return clamp
3. Work piece
4. Weld material covered by electrode flux or slag
5. Electrode
6. Distance from work to electrode (arc Length)

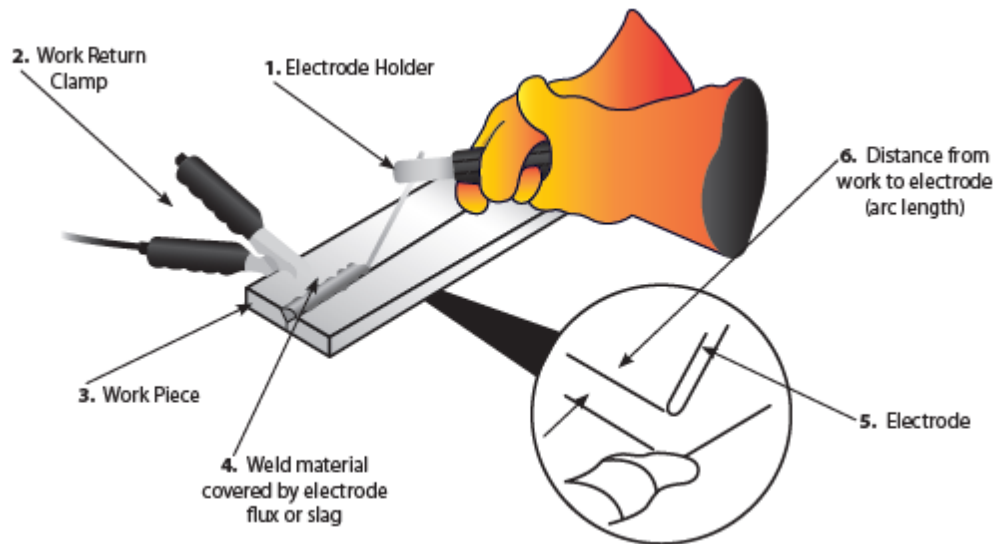

Welding current will flow in the circuit as soon as the electrode contacts the work piece. The welder should always ensure a good connection of the work clamp. The nearer the clamp is placed to the welding area the better.

When the arc is struck the distance between the end of the electrode and the work will determine the arc voltage and also affect the weld characteristic. As a guide the arc length for electrodes up to 3.2mm diameter should be around 1.6mm and over 3.2mm around 3mm.

Upon completion of the weld the welding flux or slag will need to be removed usually with a chipping hammer and wire brush.

Joint form in MMA

In MMA welding, the common basic joint forms: butt joint, corner joint, lap joint & T joint.

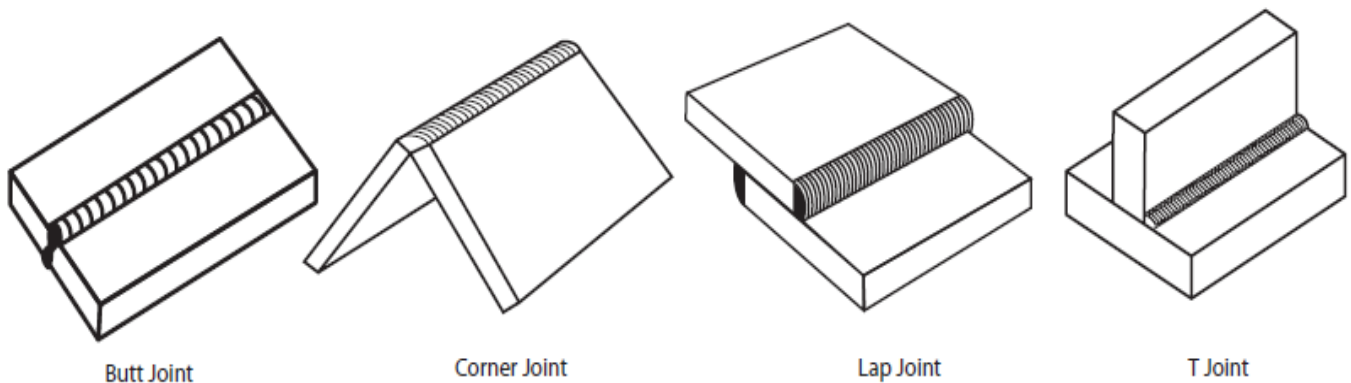

Butt Joint

Corner Joint

Lap Joint

T Joint

GUIDE TO MMA WELDING



Before starting any welding activity ensure that you have suitable eye protection and protective clothing.

Also take the necessary steps to protect any persons within the welding area.

MMA arc striking

Tap Technique - Lift the electrode upright and bring it down to strike the work piece. After forming a short circuit, quickly lift up about 2 ~ 4mm and arc will be ignited. This method is difficult to master.

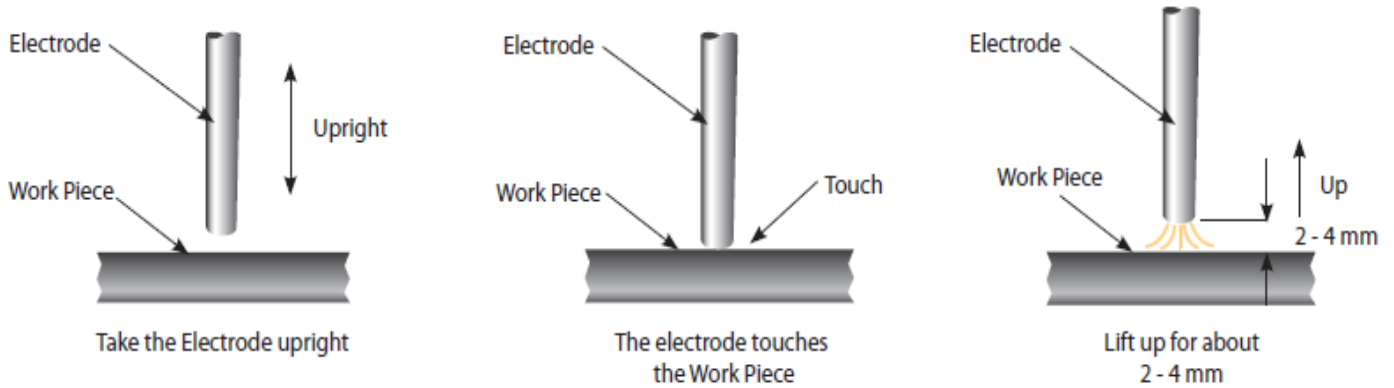

Scratch technique - Drag the electrode and scratch the work piece as if striking a match. Scratching the electrode may cause the arc to burn along the scratch path, so care should be taken to scratch in the weld zone. When the arc is struck adopt the correct welding position.

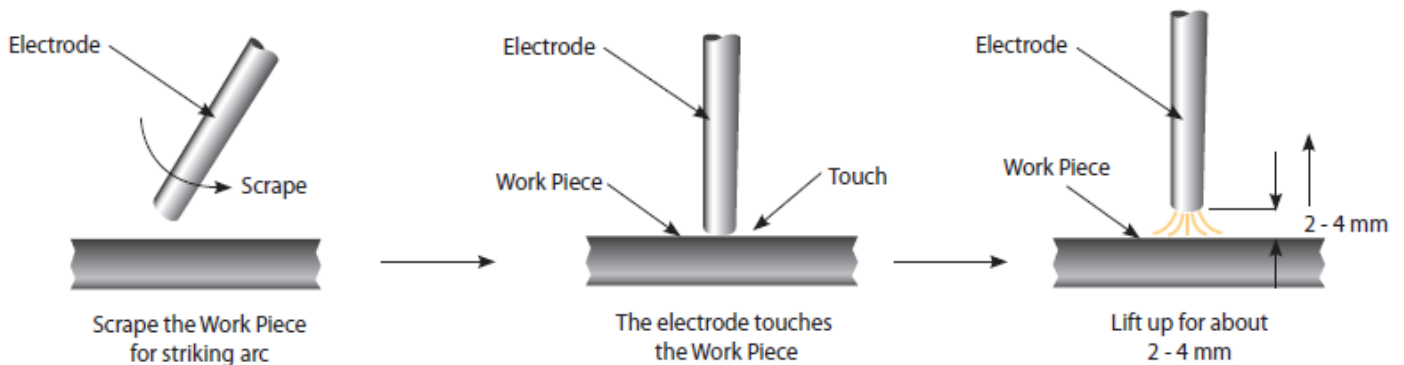

Electrode positioning

Horizontal or flat position

The electrode should be positioned at right angles to the plate and inclined in the direction of travel at around $10^\circ \sim 30^\circ$.

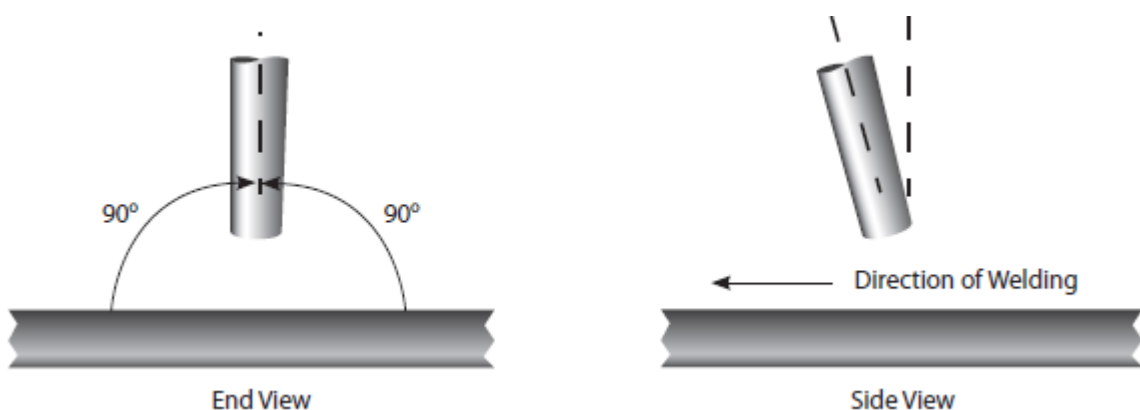

GUIDE TO MMA WELDING



Before starting any welding activity ensure that you have suitable eye protection and protective clothing.

Also take the necessary steps to protect any persons within the welding area.

Fillet welding

The electrode should be positioned to split the angle i.e. 45° . Again the electrode should be inclined in the direction of travel at around $10^\circ \sim 30^\circ$.

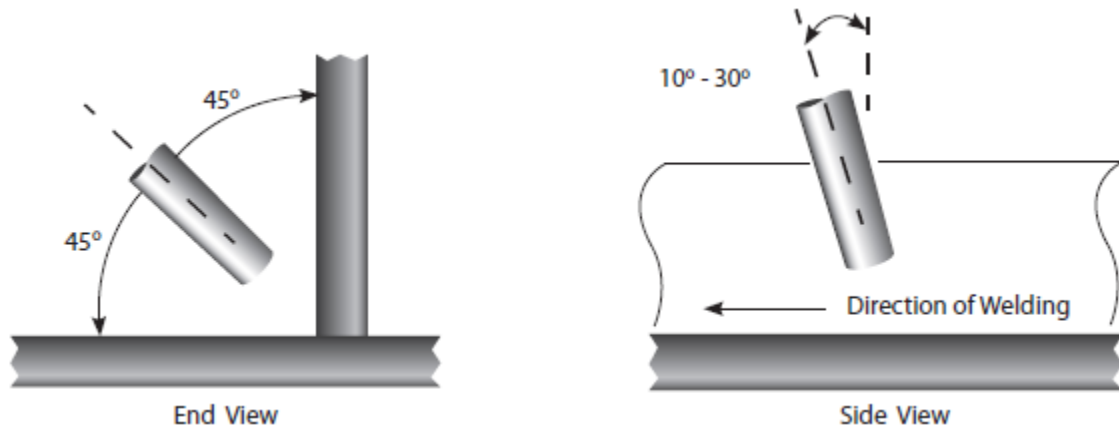

Manipulation of electrode

In MMA welding there are three motions used at the end of electrode:

1. The electrode feeding to the molten pool along axes
2. The electrode swing right and left
3. The electrode moving in the weld direction

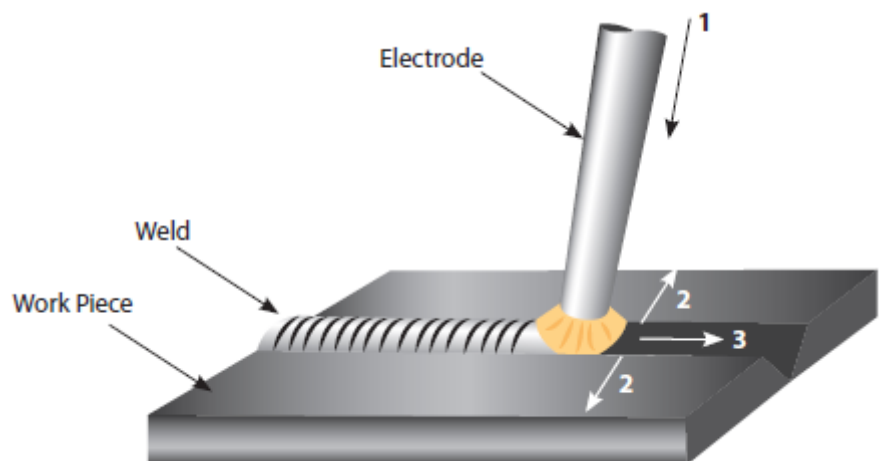

The operator can choose the manipulation of electrode based on welding joint, welding position, electrode spec, welding current and operation skill etc.

Weld characteristics

A good weld bead should exhibit the following characteristics:

1. Uniform weld bead
2. Good penetration into the base material
3. No overlap
4. Fine spatter level

A poor weld bead should exhibit the following characteristics:

1. Uneven and erratic bead
2. Poor penetration into the base material
3. Bad overlap
4. Excessive spatter levels
5. Weld crater

GUIDE TO MMA WELDING



Before starting any welding activity ensure that you have suitable eye protection and protective clothing. Also take the necessary steps to protect any persons within the welding area.

Notes for the welding beginner

This section is designed to give the beginner who has not yet done any welding some information to get them going. The simplest way to start is to practice by running weld beads on a piece of scrap plate. For example, start by using mild steel (paint free) plate of 6.0mm thick and using 3.2mm electrodes. Clean any grease, oil and loose scale from the plate and fix firmly to your work bench so that welding can be carried out.

Make sure that the work return clamp is secure and making good electrical contact with the mild steel plate, either directly or through the work table. For best results always clamp the work lead directly to the material being welded, otherwise a poor electrical circuit may create itself.

Welding position

When welding, ensure you place yourself in a comfortable position for welding and your welding application before you begin to weld. This may be sitting at a suitable height which often is the best way to weld ensuring you're relaxed and not tense. A relaxed posture will ensure the welding task becomes much easier.

Please ensure you always wear suitable PPE and use suitable fume extraction when welding.

Place the work so that the direction of welding is across, rather than to or from your body.

The electrode holder lead should always be clear of any obstruction so that you can move your arm freely along as the electrode burns down. Some welders prefer to have the welding lead over their shoulder, this allows greater freedom of movement and can reduce the weight from your hand.

Always inspect your welding equipment, welding cables and electrode holder before each use to ensure it's not faulty or worn as you may be at risk of an electric shock.

MMA process features and benefits

The versatility of the process and the skill level required to learn, basic simplicity of the equipment make the MMA process one of the most common used throughout the world.

The MMA process can be used to weld a wide variety of materials and is normally used in the horizontal position but can be used in vertical or overhead with the correct selection of electrode and current. In addition, it can be used to weld at long distances from the power source subject to the correct cable sizing. The self-shielding effect of the electrode coating makes the process suitable for welding in external environments. It is the dominant process used in maintenance and repair industries and is used extensively in structural and fabrication work.

The process is well able to cope with less than ideal material conditions such as dirty or rusty material. Disadvantages of the process are the short welds, slag removal and stop starts which lead to poor weld efficiency which is in the region of 25%. The weld quality is also highly dependent on the skill of the operator and many welding problems can exist.

MMA WELDING TROUBLESHOOTING



Before starting any welding activity ensure that you have suitable eye protection and protective clothing.

Also take the necessary steps to protect any persons within the welding area.

Arc welding defects and prevention methods

<u>Defect</u>	<u>Possible cause</u>	<u>Action</u>
Excessive spatter (beads of metal scattered around the weld area)	Amperage too high for the selected electrode	Reduce amperage or utilise larger diameter electrode
	Voltage too high or arc length too long	Reduce arc length or voltage
Uneven and erratic weld bead and direction	Weld bead is inconsistent and misses joint due to operator	Operator training required
Lack of penetration – The weld bead fails to create complete fusion between material to be welded, often surface appears okay but weld depth is shallow	Poor joint preparation	Joint design must allow for full access to the root of the weld
	Insufficient heat input	Material too thick Increase the amperage or increase the electrode size and amperage
	Poor weld technique	Reduce travel speed Ensure the arc is on the leading edge of the weld puddle
Porosity – Small holes or cavities on the surface or within the weld material	Work piece dirty	Remove all contaminant from the material i.e. oil, grease, rust, moisture prior to welding
	Electrode is damp	Replace or dry the electrode
	Arc length is excessive	Reduce the arc length
Excessive penetration – The weld metal is below the surface level of the material and hangs below	Heat input too high	Reduce the amperage or use a smaller electrode and lower amperage
	Poor weld technique	Use correct welding travel speed
Burning through – Holes within the material where no weld exists	Heat input too high	Use lower amperage or smaller electrode Use correct welding travel speed
Poor fusion – Failing of weld material to fuse either with the material to be welded or previous weld beads	Insufficient heat level	Increase the amperage or increase the electrode size and amperage
	Poor welding technique	Joint design must allow for full access to the root of the weld Alter welding technique to ensure penetration such as weaving, arc positioning or stringer bead technique
	Work piece dirty	Remove all contaminant from the material i.e. oil, grease, rust, moisture prior to welding

LIFT TIG SETUP



Before starting any welding activity ensure that you have suitable eye protection and protective clothing. Also take the necessary steps to protect any persons within the welding area.

LIFT TIG welding mode

Terms used: TIG – Tungsten Inert Gas, GTAW – Gas Tungsten Arc Welding.

TIG welding is an arc welding process that uses a non-consumable tungsten electrode to produce the heat for welding.

The weld area is protected from atmospheric contamination by a shielding gas (usually an inert gas such as argon or helium) and a filler rod matching the base material is normally used, though some welds, known as autogenous welds, are carried out without the need for filler wire.

The LIFT TIG welding process with the EM-200CT and EM-250CT Machines is in the DC process (Direct Current) for welding steel and stainless steel etc.

With the EVO range of machines a euro style (as shown below) type TIG torches can be used.

Using the euro style TIG torch, connect the TIG torch euro style plug to the (MIG) Euro connector outlet and rotate clockwise to tighten.

Ensure the trailing lead is connected into the “-” socket on the front panel of the machine and fully tightened clockwise.

Insert the dinse plug on the work return cable into the “+” socket on the front panel of the machine and rotate clockwise to tighten.

Attach the work clamp to the work piece.

Connect the supply gas hose to the gas inlet on the back panel of the machine. The other end of the supply hose connects to the gas regulator or flowmeter on the gas cylinder.

Press the gas purge button on the control panel to activate the gas solenoid to allow gas to flow, this will allow you to set the gas flow level.

Adjust the welding current according to the thickness of the work piece to be welded (for a guide to TIG welding parameters, please refer to the table below).

Allow the TIG torch tungsten to touch the work piece and then press the torch trigger.

Gas will then start to flow, output voltage will also activate and then lift the TIG torch 2 ~ 4mm away from the work piece and the arc will initiate and the welding will commence and be maintained at the preset welding, welding can be carried out.

Releasing the torch trigger will stop the welding arc although the shielding gas will continue flowing for the preset post flow time, welding then ends.

The amperage guide for TIG welding tungsten sizes can vary depending on material, work piece thickness, welding position and joint form.

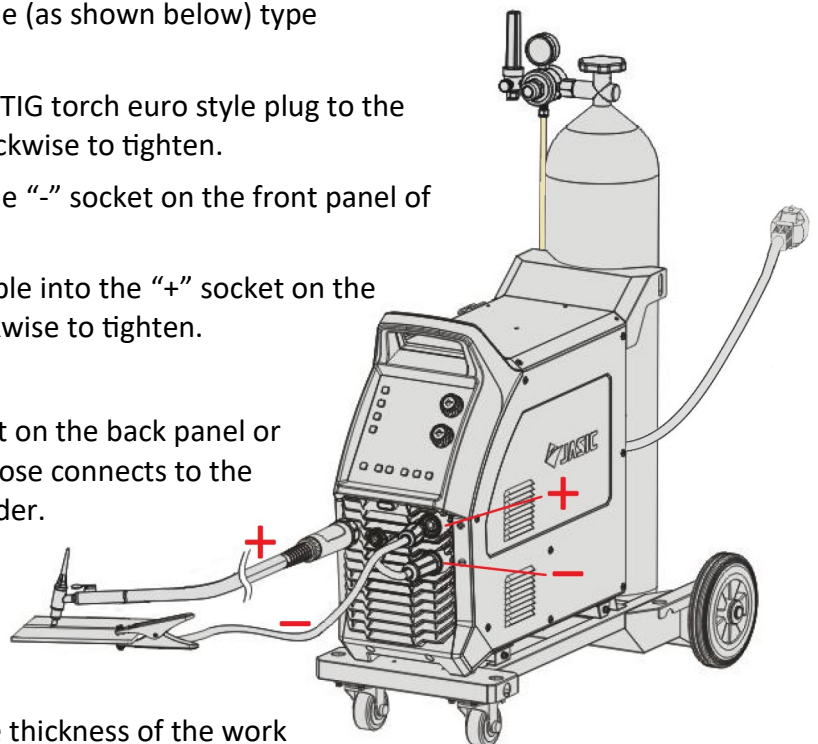
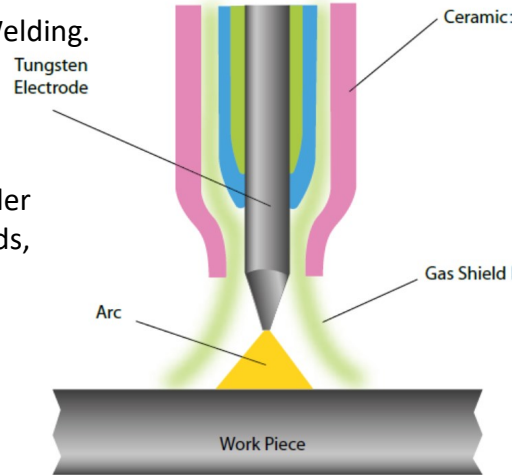

Tungsten Size	DC – Electrode Negative
1.0mm	15 – 80A
1.6mm	70 – 150A
2.4mm	150 – 250A
3.2mm	250A – 400A

OPERATION - LIFT TIG



Before starting any welding activity ensure that you have suitable eye protection and protective clothing. Also take the necessary steps to protect any persons within the welding area.

Lift TIG operation steps



The selection area for selecting the Lift TIG mode, pressing the green welding process mode selection button until the (bottom) Lift TIG DC LED is illuminated as shown left for either the EM-200CT or the EM-250CT model.

Select the 2T torch trigger mode by pressing the torch mode button until the 2T LED (top) is illuminated as shown right.



To select Lift TIG welding mode, press the green arrow button until the TIG symbol is illuminated as shown in the image right (circled red).

Lift TIG Welding Current Adjustment

TIG welding current adjustment can now be carried out via the panel control current adjustment dial and this can be achieved by rotating the top encoder dial 'A' (as shown left) either clockwise or anticlockwise which will increase or decrease the welding amperage shown on the current display along side the dial.

The welding current adjustment range is 10 ~ 160 amps 10 ~ 200 amps (230v mode) depending on model.

Note: Welding current adjustment can be carried out during welding.

When in Lift TIG mode, you can now adjust Lift TIG parameters such as pre & post gas flow and current downslope time and these which are adjusted via the welding engineer mode (WEM) function that allows the users to adjust a number of background default parameters or functions.

To access WEM, press and hold the top adjustment knob 'A' for 5 seconds, after pressing and holding this knob for 2 seconds, the machine will show a count down from 3 seconds, at the end of the countdown, the top display window will show the parameter number "F01" with the bottom parameter displaying the value corresponding to that 'F' number.

By rotating the top parameter adjustment dial will allow you to select the required parameter number to set the back-end parameter default value or function (see pages 25 & 26 for further details).

- **Lift TIG pre-gas selection and adjusting:**

To select pre flow gas time setting, rotate the top adjustment dial until F03 is displayed, by rotating the bottom dial, you can then adjust the pre flow time shown in the bottom display window. The pre flow adjustment range is 0 ~ 5 seconds and the factory setting is 0.5 seconds.

- **Lift TIG post-gas selection and adjustment:**

To select post flow gas time setting, rotate the top adjustment dial until F04 is displayed, by rotating the bottom dial, you can then adjust the pre flow time shown in the bottom display window. The pre flow adjustment range is 0 ~ 10 seconds and the factory setting is 5 seconds.

- **Lift TIG downslope time selection and adjustment:**

To select and adjust downslope time, rotate the top adjustment dial until F05 is displayed. Then by rotating the bottom dial you can then adjust the downslope time which is shown in the bottom display window. The downslope time range is 0 ~ 5 seconds and the factory setting is 0.5 seconds.

Pressing the green button exits the welding engineers mode and saves your Lift TIG settings.

OPERATION LIFT TIG



Before starting any welding activity ensure that you have suitable eye protection and protective clothing. Also take the necessary steps to protect any persons within the welding area.

Torch Trigger Operation

Indicator for 2T

Indicator for 4T



2T mode (normal trigger control)

The 2T (↑↓) LED light will illuminate when the power source is in 2T welding mode. In this mode, the torch trigger must remain pressed (closed) for the welding output to be active. See example below:

Press and hold the torch trigger to activate the power source, the gas valve and gas will flow. After the gas pre flow time ends, the welding arc will ignite when the tungsten touches and then is retracted from the work piece and then the current rises up (slope up time) to the welding current value gradually until you achieve the preset welding current.

When the torch switch is released, the current begins to drop gradually (slope down time) and when it drops to the minimum current value, the welding output is cut off and the gas valve will close, once the post flow time ends, this is the end of the welding process. If the torch switch is pressed down during the current downslope period, the current will rise up again to the preset welding current value and the slope out process will only start again once the torch switch to be released.

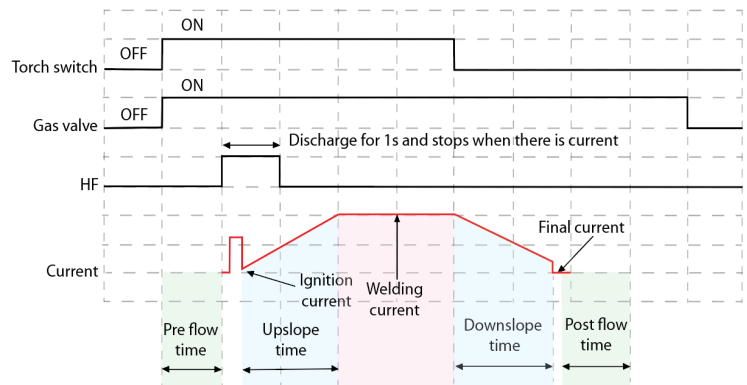

4T (latch trigger control)

The 4T (↑↓) LED will illuminate when the power source is in 4T welding mode, this trigger mode is mainly used for long welding runs to assist in reducing operator finger fatigue. In this mode the user can press and release the torch trigger and the output will remain active until the trigger switch is depressed again and released.

In 4T mode, the gas valve opens when the torch switch is pressed down, after the pre flow time ends, the welding arc will ignite when the tungsten touches and then is retracted from the work piece. Once the welding arc has successfully ignited the initial current value is active and the torch switch can now be released, the welding current rises up to the preset welding current value gradually and you will continue to weld your material.

To finish welding, simply press the torch switch down again and the current will begin to gradually drop (slope out time) to the final current value. When the torch switch is released the current output is cut off and the gas will continue to flow until your preset post flow time has elapsed.

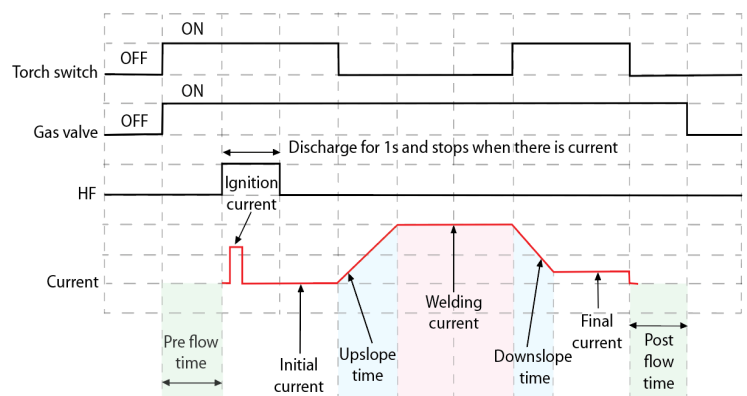

GUIDE TO TIG WELDING



Before starting any welding activity ensure that you have suitable eye protection and protective clothing. Also take the necessary steps to protect any persons within the welding area.

TIG torch body and components

The torch body holds the various welding consumables in place as shown and is covered by either a rigid phenolic or rubberised covering.

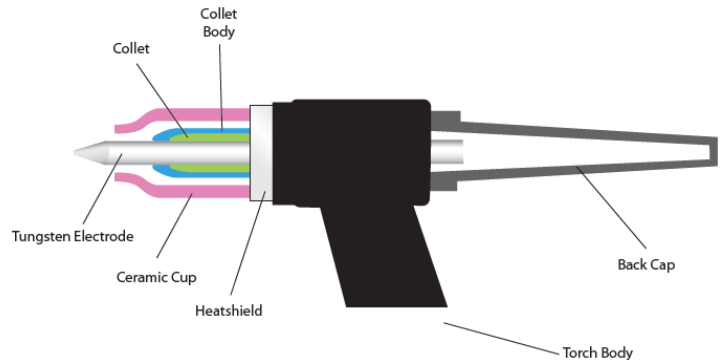

Collet body



The collet body screws into the torch body. It is replaceable and is changed to accommodate the different sizes tungsten's and their respective collets.

Collets



The welding electrode (tungsten) is held in the torch by the collet. The collet is usually made of copper or a copper alloy. The collet's grip on the electrode is secured when the torch back cap is tightened in place. Good electrical contact between the collet and tungsten electrode is essential for good welding current transfer.

Gas lens body

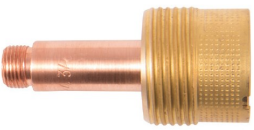

A gas lens is a device that can be used in place of the normal collet body. It screws into the torch body and is used to reduce turbulence in the flow of shield gas and produce a stiff column of undisturbed flow of shielding gas. A gas lens will allow the welder to move the nozzle further away from the joint allowing increased visibility of the arc.

A much larger diameter nozzle can be used which will produce a large blanket of shielding gas. This can be very useful in welding material like titanium. The gas lens will also enable the welder to reach joints with limited access such as inside corners.

Ceramic cups



Gas cups are made of various types of heat resistant materials in different shapes, diameters and lengths. The cups are either screwed onto the collet body or gas lens body or in some cases pushed in place. Cups can be made of ceramic, metal, metal-jacketed ceramic, glass or other materials. The ceramic type is quite easily broken so take care when putting the torch down.

Gas cups must be large enough to provide adequate shielding gas coverage to the weld pool and surrounding area. A cup of a given size will allow only a given amount of gas to flow before the gas flow becomes disturbed due to the speed of flow. Should this condition exist the size of cup should be increased to allow the flow speed to reduce and once again establish an effective regular shield.

Back cap

The back cap screws into the rear on the torch head and applies pressure to the back end of the collet which in turn forces up against the collet body, the resulting pressure holds the tungsten in place to ensure it does not move during the welding process.

Back caps are made from a rigid phenolic material and generally come in 3 sizes, short, medium and long.

GUIDE TO TIG WELDING



Before starting any welding activity ensure that you have suitable eye protection and protective clothing. Also take the necessary steps to protect any persons within the welding area.

TIG welding electrodes

TIG welding electrodes are a 'non consumable' as it is not melted into the weld pool and great care should be taken not to let the electrode contact the welding pool to avoid weld contamination. This would be referred to as tungsten inclusion and may result in weld failure.

Electrodes will often contain small quantities of metallic oxides which can offer the following benefits:

- Assist in arc starting
- Improve current carrying capacity of the electrode
- Reduce the risk of weld contamination
- Increase electrode life
- Increase arc stability

Oxides used are primarily zirconium, thorium, lanthanum or cerium. These are added usually 1% - 4%.



Tungsten Electrode Colour Chart - DC

Welding Mode	Tungsten Type	Colour
DC or AC/DC	Ceriated 2%	Grey
DC or AC/DC	Lanthanated 1%	Black
DC or AC/DC	Lanthanated 1.5%	Gold
DC or AC/DC	Lanthanated 2%	Blue
DC	Thoriated 1%	Yellow
DC	Thoriated 2%	Red

Tungsten Electrode Current Ranges

Tungsten Electrode Size	DC Current Amp
1.0mm	30 - 60
1.6mm	60 - 115
2.4mm	100 - 165
3.2mm	135 - 200
4.0mm	190 - 280
4.8mm	250 - 340

Tungsten electrode preparation - DC

When welding at low current the electrode can be ground to a point.

At higher current a small flat on the end of the electrode is preferable as this helps with arc stability.

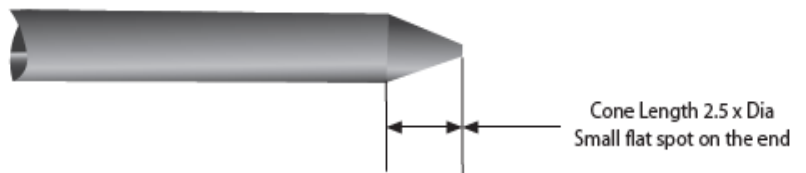

On inverter controlled AC & DC machines use tungsten electrode with cone length around 2.5 times the tungsten diameter

Electrode grinding

It is important when grinding the electrode to take all necessary precautions such as wearing eye protection and ensuring adequate protection against breathing in any grinding dust.

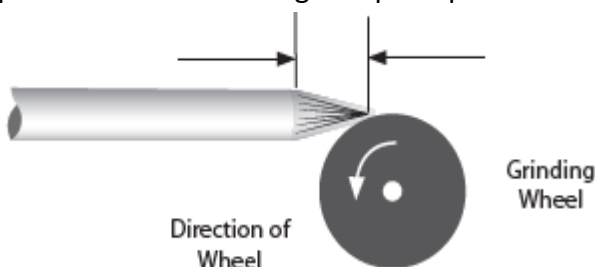

Tungsten electrodes should always be ground lengthwise (as shown) and not in a radial operation. Electrodes ground in a radial operation tend to contribute to arc wander due to the arc transfer from the grinding pattern. Always use a grinder solely for grinding electrodes to avoid contamination.

GUIDE TO TIG WELDING



Before starting any welding activity ensure that you have suitable eye protection and protective clothing. Also take the necessary steps to protect any persons within the welding area.

TIG welding consumables

The consumables of the TIG welding process are filler wires and shield gas.

Filler wires

Filler wires come in many different material types and usually as cut lengths, unless some automated feeding is required where it will be in reel form. Filler wire is generally fed in by hand. Always consult the manufacturer's data and welding requirements.

Filler Wire Diameter	DC Current Range (Amps)
1.0mm	20-90
2.4mm	65-115
3.2mm	100-165
4.8mm	200-350

Filler Wire Selection Guide

Gases

Shielding gas is required when welding to keep the weld pool free of oxygen. Whether you are welding mild steel or stainless steel the most commonly used shielding gas used in TIG welding is argon, for more specialised applications an argon helium mix or pure helium may be used.

TIG welding - arc starting

The TIG process can use both non contact and contact methods to provide arc starting. Depending on the Jasic model, the options are indicated on a selector switch on the front control panel of the power source. The most common method of arc starting is 'HF' start. This term is often used for a variety of starting methods and covers many different types of start.

Arc starting - scratch start

This system is where the electrode is scratched along the work piece like striking a match. This is a basic way of turning any DC stick welder into a TIG welder without much work. It is not considered suitable for high integrity welding due to the fact that the tungsten can be melted on the work piece thereby contaminating the weld.

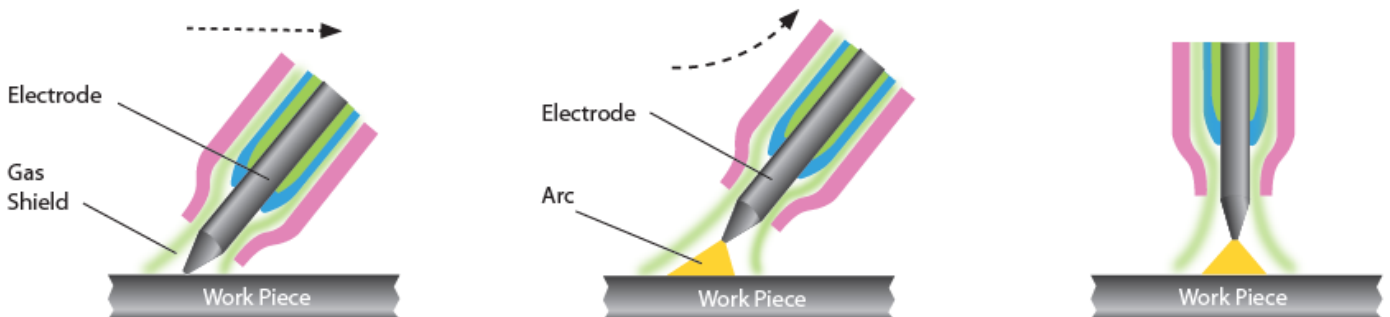

The main challenge with scratch start TIG welding is keeping your electrode clean. While a quick strike with the electrode on the metal is essential and then not lifting it more than 3mm away to create the arc will help, you also need to ensure your metal is completely clean.

GUIDE TO TIG WELDING



Before starting any welding activity ensure that you have suitable eye protection and protective clothing. Also take the necessary steps to protect any persons within the welding area.

Lift TIG (lift arc)

Not to be confused with scratch start, this arc starting method allows the tungsten to be in direct contact with the work piece first but with minimal current so as not to leave a tungsten deposit when the tungsten is lifted and an arc is established.

With lift TIG, the open circuit voltage (OCV) of the welder folds back to a very low voltage output when the unit senses it has made continuity with the work piece. Once the torch is lifted the unit increases output as the tungsten leaves the surface. This creates little contamination and preserves the point on the tungsten although this is still not a 100% clean process. The tungsten still can get contaminated but lift TIG is still a much better option than scratch starting, for mild and stainless steel although these methods of arc starting are not a good option when welding aluminium.

The Jasic EVO EM range offers Lift TIG mode utilising the TIG torch switch operation mode which starts the process with the internal gas valve opening to start the gas flow first.

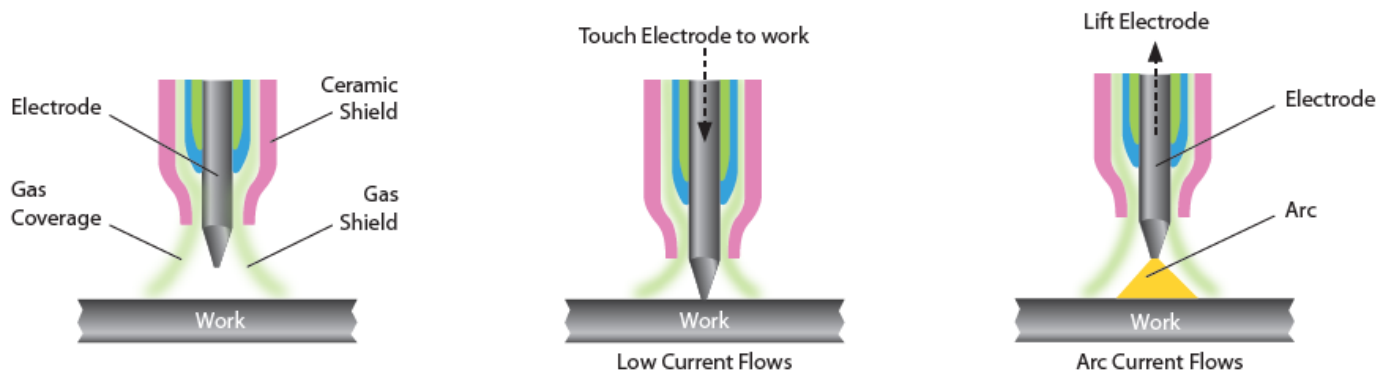

Set the TIG welding current and other TIG welding parameters by using the control dial. (see page 31 onwards for further details)

LIFT TIG process

Press the TIG torch switch, then touch the tungsten electrode to the work piece for less than 2 seconds and then lift away to 2-4mm from the work piece and the welding arc is then established.

Once welding is complete release the torch trigger to disengage the welding arc but ensure you leave the torch in place to shield the weld with gas for a few seconds and then turn off the gas at the valve on the torch head.

PLEASE NOTE:

- When starting the arc if the short-circuit time exceeds 2 seconds the welder turns off the output current, lift the welding torch tungsten away from the work piece and restart the process as above to start the arc again.
- During welding, if there is short circuit between tungsten electrode and the work piece, the welder will immediately reduce the output current; if the short circuit exceeds 1 second, the welder will turn off the output current. If this happens, the arc will need to be restarted as above and the welding torch needs to be lifted to start the arc again.

GUIDE TO DC TIG WELDING



Before starting any welding activity ensure that you have suitable eye protection and protective clothing. Also take the necessary steps to protect any persons within the welding area.

Manual DC TIG Welding Amperage Guide- Mild Steel and Stainless Steel

Base Metal Thickness mm	Base Metal Thickness Inch	Tungsten Electrode Diameter	Output Polarity	Filler Wire Diameter (If Required)	Argon Gas Flow Rate (Litres/Min)	Joint Types	Amperage Range
1.6mm	1/16"	1.6mm	DC	1.6mm	5 - 8	Butt	50 - 80
1.6mm	1/16"	1.6mm	DC	1.6mm	5 - 8	Corner	50 - 80
1.6mm	1/16"	1.6mm	DC	1.6mm	5 - 8	Fillet	60 - 90
1.6mm	1/16"	1.6mm	DC	1.6mm	5 - 8	Lap	60 - 90
2.4mm	3/32"	1.6/2.4mm	DC	1.6/2.4mm	5 - 9	Butt	80 - 110
2.4mm	3/32"	1.6/2.4mm	DC	1.6/2.4mm	5 - 9	Corner	80 - 110
2.4mm	3/32"	1.6/2.4mm	DC	1.6/2.4mm	5 - 9	Fillet	90 - 120
2.4mm	3/32"	1.6/2.4mm	DC	1.6/2.4mm	5 - 9	Lap	90 - 120
3.2mm	1/8"	2.4mm	DC	2.4mm	5 - 10	Butt	80 - 120
3.2mm	1/8"	2.4mm	DC	2.4mm	5 - 10	Corner	90 - 120
3.2mm	1/8"	2.4mm	DC	2.4mm	5 - 10	Fillet	100 - 140
3.2mm	1/8"	2.4mm	DC	2.4mm	5 - 10	Lap	100 - 140
4.8mm	3/16"	2.4mm	DC	2.4mm	6 - 11	Butt	120 - 200
4.8mm	3/16"	2.4mm	DC	2.4mm	6 - 11	Corner	150 - 200
4.8mm	3/16"	2.4mm	DC	2.4mm	6 - 11	Fillet	170 - 220
4.8mm	3/16"	2.4mm	DC	2.4mm	6 - 11	Lap	150 - 200
6.4mm	1/4"	2.4mm	DC	3.2mm	7 - 12	Butt	225 - 300
6.4mm	1/4"	2.4mm	DC	3.2mm	7 - 12	Corner	250 - 300
6.4mm	1/4"	2.4mm	DC	3.2mm	7 - 12	Fillet	250 - 320
6.4mm	1/4"	2.4mm	DC	3.2mm	7 - 12	Lap	250 - 320
9.5mm	3/8"	3.2mm	DC	3.2mm	7 - 12	Butt	250 - 360
9.5mm	3/8"	3.2mm	DC	3.2mm	7 - 12	Corner	260 - 360
9.5mm	3/8"	3.2mm	DC	3.2mm	7 - 12	Fillet	270 - 380
9.5mm	3/8"	3.2mm	DC	3.2mm	7 - 12	Lap	230 - 380
12.7mm	1/2"	3.2/4mm	DC	3.2mm	8 - 13	Butt	300 - 400
12.7mm	1/2"	3.2/4mm	DC	3.2mm	8 - 13	Corner	320 - 420
12.7mm	1/2"	3.2/4mm	DC	3.2mm	8 - 13	Fillet	320 - 420
12.7mm	1/2"	3.2/4mm	DC	3.2mm	8 - 13	Lap	320 - 420

Please Note:

- All above guide settings are approximate and will vary depending on application, prep, passes and type of welding equipment used.
- The welds would need to be tested to ensure they comply to your welding specifications.

TIG WELDING TORCH: EURO TYPE FOR EM-200CT and EM-250CT PFC

TIG Welding Torch Air Cooled - Model TIG54 (euro type)

Rating 350A DC, 260A AC @ 100% Duty Cycle EN60974-7 • 0.5mm to 4.0mm Electrodes

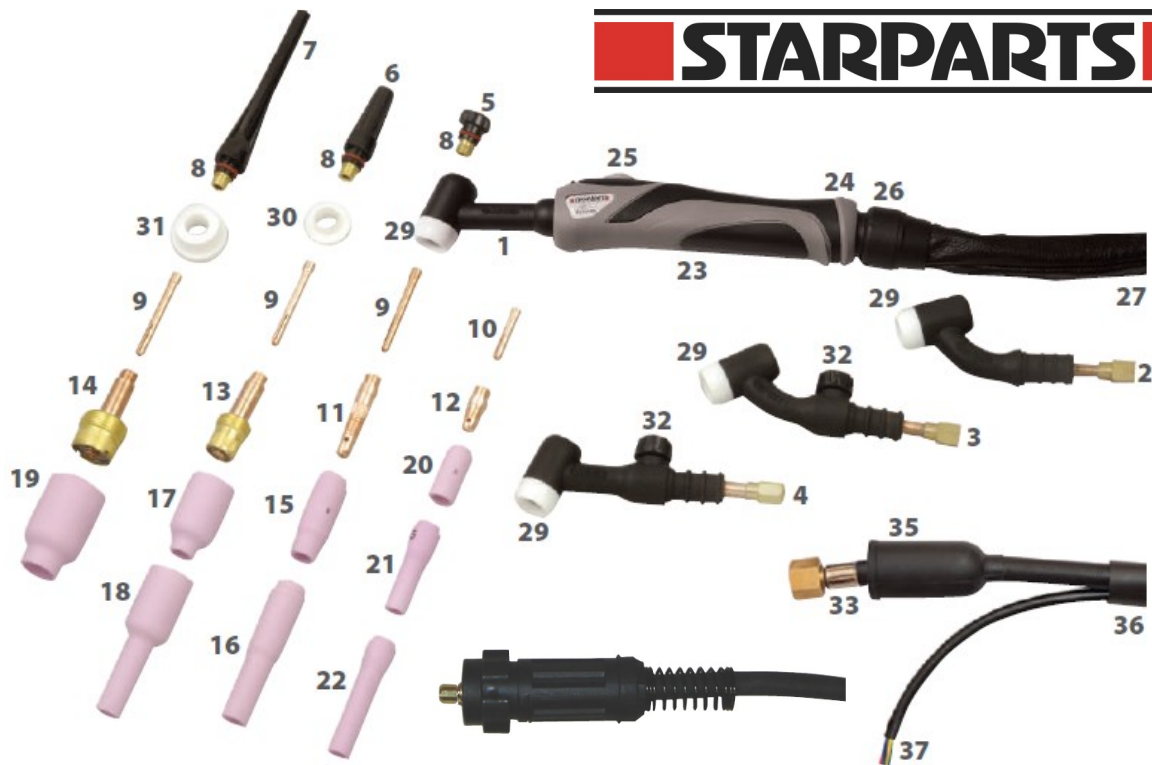

Main Consumables

No	Code	Description
1	WP17	Rigid Torch Body
2	WP17F	Flexible Torch Body
3	WP17FV	Flexible Torch Body c/w Valve
4	WP17V	Torch Body c/w Argon Valve
5	57Y04	Short Back Cap
6	300M	Medium Back Cap
7	57Y02	Long Back Cap
8	98W18	Back Cap 'O' Ring

Collets

9	10N21	Standard .020" (0.5mm)
	10N22	Standard .040" (1.0mm)
	10N23	Standard 1/16" (1.6mm)
	10N26	Standard 5/64" (2.0mm)
	10N24	Standard 3/32" (2.4mm)
	10N25	Standard 1/8" (3.2mm)
10	10N21S	Stubby .020" (0.5mm)
	10N22S	Stubby .040" (1.0mm)
	10N23S	Stubby 1/16" (1.6mm)
	10N24S	Stubby 3/32" (2.4mm)
	10N25S	Stubby 1/8" (3.2mm)

Collet Bodies

11	10N29	Standard .020" (0.5mm)
	10N30	Standard .040" (1.0mm)
	10N31	Standard 1/16" (1.6mm)
	10N31M	Standard 5/64" (2.0mm)
	10N32	Standard 3/32" (2.4mm)
	10N28	Standard 1/8" (3.2mm)
12	17CB20	Stubby .020"- 1/8" (0.5 - 3.2mm)

Gas Lens Bodies

13	45V29	Standard .020" (0.5mm)
	45V24	Standard .040" (1.0mm)
	45V25	Standard 1/16" (1.6mm)
	45V25M	Standard 5/64" (2.0mm)
	45V26	Standard 3/32" (2.4mm)
	45V27	Standard 1/8" (3.2mm)

Gas Lens Bodies

14	45V0204	Large Dia .020"-.040" (0.5 - 1.0mm)
	45V116	Large Dia 1/16" (1.6mm)
	45V64	Large Dia 3/32" (2.4mm)
	995795	Large Dia 1/8" (3.2mm)

Ceramic Cups

15	10N50	Standard Cup 1/4" Bore
	10N49	Standard Cup 5/16" Bore
	10N48	Standard Cup 3/8" Bore
	10N47	Standard Cup 7/16" Bore
	10N46	Standard Cup 1/2" Bore
	10N45	Standard Cup 5/8" Bore
	10N44	Standard Cup 3/4" Bore
16	10N50L	Long Cup 1/4" Bore
	10N49L	Long Cup 5/16" Bore
	10N48L	Long Cup 3/8" Bore
	10N47L	Long Cup 7/16" Bore

Gas Lens Cups

17	54N18	Standard Cup 1/4" Bore
	54N17	Standard Cup 5/16" Bore
	54N16	Standard Cup 3/8" Bore
	54N15	Standard Cup 7/16" Bore
	54N14	Standard Cup 1/2" Bore
	54N19	Standard Cup 11/16" Bore
18	54N17L	Long Cup 5/16" Bore
	54N16L	Long Cup 3/8" Bore
	54N15L	Long Cup 7/16" Bore
	54N14L	Long Cup 1/2" Bore
19	57N75	Large Dia Cup 3/8" Bore
	57N74	Large Dia Cup 1/2" Bore
	53N88	Large Dia Cup 5/8" Bore
	53N87	Large Dia Cup 3/4" Bore

Ceramic Cups for use with item 12

No	Code	Description
20	13N08	Standard Cup 1/4" Bore
	13N09	Standard Cup 5/16" Bore
	13N10	Standard Cup 3/8" Bore
	13N11	Standard Cup 7/16" Bore
	13N12	Standard Cup 1/2" Bore
	13N13	Standard Cup 5/8" Bore
21	796F70	Long Cup 3/16" Bore
	796F71	Long Cup 1/4" Bore
	796F72	Long Cup 5/16" Bore
	796F73	Long Cup 3/8" Bore
22	796F74	X - Long Cup 3/16" Bore
	796F75	X - Long Cup 1/4" Bore
	796F76	X - Long Cup 5/16" Bore
	796F77	X - Long Cup 3/8" Bore

Secondary Consumables

23	SP9110	LH & RH Handle Shell
24	SP9111	Handle Screw
25	SP9120	Single Button Switch
	SP9121	2 Button Switch
	SP9122	5K Potentiometer Switch
	SP9123	10K Potentiometer Switch
	SP9128	47K Potentiometer Switch
	SP9129	4 Button Switch
26	SP9113	Handle Ball Joint
27	SP9116	Leather Cover 800mm
28	SP9118	Cable Cover Joint (not illustrated)
29	18CG	Standard Heat Shield
30	54N01	Gas Lens Heat Shield
31	54N63	Large Gas Lens Insulator
32	VS-2	Valve Stem WP17V & WP17FV
33	57Y01	Mono Power Cable 12.5ft - 3/8"
	57Y03	Mono Power Cable 25ft - 3/8" Bsp
34	57Y01-2D	2 Piece Power Cable Assy 12.5ft
	57Y03-2D	2 Piece Power Cable Assy 25ft
35	0315071	Insulation Boot
36	SP9002	Neoprene Protective Cover 1m
37	SP9126	4m Switch Cable
	SP9127	8m Switch Cable
--	JSP-01	2 Pin Control Plug (TIG Torch)
--	10004655	5 Pin Control Plug (Remote)

PLEASE NOTE:

Check torch supplied with your package to ensure it matches the above details. The product maybe supplied with a Jasic orange torch handle

TIG WELDING TROUBLESHOOTING



Before starting any welding activity ensure that you have suitable eye protection and protective clothing. Also take the necessary steps to protect any persons within the welding area.

TIG welding defects and prevention methods

<u>Defect</u>	<u>Possible cause</u>	<u>Action</u>
Excessive tungsten use	Set up for DCEP	Change to DCEN
	Insufficient shield gas flow	Check for gas restriction and correct flow rates. Check for drafts in the weld area
	Electrode size too small	Select correct size
	Electrode contamination during cooling time	Extend post flow gas time
Porosity/weld contamination	Loose torch or hose fitting	Check and tighten all fitting
	Inadequate shield gas flow	Adjust flow rate - normally 8-12L/m
	Incorrect shield gas	Use correct shield gas
	Gas hose damaged	Check and repair any damaged hoses
	Base material contaminated	Clean material properly
	Incorrect filler material	Check correct filler wire for grade of use
No operation when torch switch is operated	Torch switch or cable faulty	Check the torch switch continuity and repair or replace as required
	ON/OFF switch turned off	Check position of ON/OFF switch
	Mains fuses blown	Check fuses and replace as required
	Fault inside the machine	Call for a repair technician
Low output current	Loose or defective work clamp	Tighten/replace clamp
	Loose cable plug	Check and tighten all plugs
	Power source faulty	Call a repair technician
High frequency will not strike the arc	Weld/power cable open circuit	Check all cables and connections for continuity, especially the torch cables
	No shield gas flowing	Check cylinder contents, regulator and valves, also check the power source
Unstable arc when welding in DC	Tungsten contaminated	Break off contaminated end and regrind the tungsten
	Arc length incorrect	Arc length should be between 3-6mm
	Material contaminated	Clean all base and filler material
	Electrode connected to the wrong polarity	Reconnect to correct polarity
Arc is difficult to start	Incorrect tungsten type	Check and fit correct tungsten
	Incorrect shield gas	Use argon shield gas

TIG WELDING TROUBLESHOOTING



Before starting any welding activity ensure that you have suitable eye protection and protective clothing. Also take the necessary steps to protect any persons within the welding area.

TIG welding defects and prevention methods

<u>Defect</u>	<u>Possible cause</u>	<u>Action</u>
Excessive bead build up, poor penetration or poor fusion at the edges of the weld	Weld current too low	Increase the welding amperage Poor material prep
Weld bead flat and too wide or undercut at the weld edge or burning through	Weld current too high	Decrease the welding amperage
Weld bead too small or insufficient penetration	Welding travel speed too fast	Reduce your welding travel speed
Weld bead too wide or excessive bead build up	Welding travel speed too slow	Increase your welding travel speed
Uneven leg length in fillet joint	Wrong placement of filler rod	Re-position filler rod
Tungsten melts or oxidises when welding arc is made	TIG torch lead connected to + Little or no gas flow to weld pool Gas cylinder or hoses contain impurities The tungsten is too small for the weld current TIG/MMA selector set to MMA	Connect to - polarity Check gas apparatus as well as torch and hoses for breaks or restrictions Change gas cylinder and blow out torch and gas hoses Increase the size of the tungsten Ensure you have the power source set to TIG function

TIG TORCH TROUBLESHOOTING

TIG welding defects and prevention methods

The TIG torch used for lift TIG welding comprises of several items which ensure current flow and arc shielding from the atmosphere.

Regular maintenance of the welding torch is one of the most important measures to ensure its normal operation and extend lifespan.

In order to ensure normal maintenance, the wearing parts of the torch should have spares, including the electrode holder, nozzle, sealing ring, insulating washer, etc.

Common faults of the welding torch include overheating, gas leakage, water leakage, poor gas protection, electric leakage, nozzle burn out, and cracking. The causes of these faults and troubleshooting methods are as shown in the following table:

Symptom	Reasons	Troubleshooting
The welding torch is overheating	The welding torch capacity is too small	Replace with a welding torch with large capacity
	The collet fails to clamp the tungsten electrode	Replace the collet or back cap
Gas leakage	The sealing ring is worn	Replace the sealing ring
	The gas connection thread is loose	Tighten it
	The gas inlet pipe joint is damaged or not fastened	Cut off the damaged joint, reconnect and tighten the replaced gas inlet pipe or wrap up the damaged area
	The gas inlet pipe has been damaged by heat or aging	Replace the gas inlet pipe
Operator receiving a shock from the torch	The torch head is wet due to leakage or other reasons	Find the cause of water leakage, and fully dry the torch head
	The torch head is damaged or the live metal part is exposed	Replace the torch head or wrap the exposed electrified metal part with adhesive tape
Poor gas flow or porosity in the weld	The welding torch is leaking	Locate the leakage
	The nozzle diameter is too small	Replace with a nozzle of larger diameter
	The nozzle is damaged or cracked	Replace with a new nozzle
	The gas circuit in the welding torch is blocked	Blow the circuit with compressed air to clear the blockage
	The gas screen has been damaged or lost during disassembly and assembly	Replace with a new gas screen
	The argon gas is impure	Replace with standard argon gas
	The gas flow is too large or small	Adjust the gas flow properly
Arc started between the collet/collet holder or the tungsten electrode/torch head	The collet and tungsten electrode have poor contact, or arc is started when the tungsten electrode contacts the base metal	Replace the collet or repair
	The collet and welding torch have poor contact	Connect the collet and welding torch properly

MAINTENANCE



The following operation requires sufficient professional knowledge on electric aspects and comprehensive safety knowledge. Make sure the input cable of the machine is disconnected from the electricity supply and wait for 5 minutes before removing the machine covers.

In order to guarantee that the arc welding machine works efficiently and in safety, it must be maintained regularly. Operators should understand the maintenance methods and means of arc welding machine operation. This guide should enable customers to carry out simple examination and safeguarding by oneself, try to reduce the fault rate and repair times of the arc welding machine, so as to lengthen service life of arc welding machines.

<u>Period</u>	<u>Maintenance item</u>
Daily examination	Check the condition of the machine, mains cables, welding cables and connections. Check for any warnings LEDs and machine operation.
Monthly examination	Disconnect from the mains supply and wait for at least 5 minutes before removing the cover. Check internal connections and tighten if required. Clean the inside of the machine with a soft brush and vacuum cleaner. Take care not to remove any cables or cause damage to components. Ensure that ventilation grills are clear. Carefully replace the covers and test the unit. This work should be carried out by a suitably qualified competent person.
Yearly examination	Carry out an annual service to include a safety check in accordance with the manufacturers standard (EN 60974-1). This work should be carried out by a suitably qualified competent person.

TROUBLESHOOTING

Before arc welding machines are dispatched from the factory, they have already been checked thoroughly. The machine should not be tampered with or altered. Maintenance must be carried out carefully. If any wire becomes loose or is misplaced, it maybe potentially dangerous to user!

Only professional maintenance personnel should repair the machine!

<u>Description of fault</u>	<u>Possible cause</u>	<u>Action</u>
The welding arc cannot be established	Power switch has not been switched ON Incoming mains power supply is not ON Possible internal power failure	- Switch ON power switch - Check incoming power switch for correct operation and supply - Have a technician check the machine and mains power supply
Difficult arc ignition	Low arc current	- Increase the arc current setting - Check condition of the MMA welding leads
Overheat Error lit	Machine operated outside duty cycle Fan not working	- Allow the machine to cool and the unit will reset automatically - Have a technician check for obstructions blocking the fan
Over current Error lit	Mains supply problem	- Have a technician check the mains supply

TROUBLESHOOTING - ERROR CODES



The following operation requires sufficient professional knowledge on electric aspects and comprehensive safety knowledge. Make sure the input cable of the machine is disconnected from the electricity supply and wait for 5 minutes before removing any machine covers.

The control display is also used for providing error messages to the user, if an error message is displayed, the power source may only function to a limited capacity and the cause of the error should be checked as soon as possible.

The below is a list of error codes for the Jasic EVO EM-200CT and EM-250CT welding machines.

Error Code	Error Code Description	Possible Cause	Check
E10	Overcurrent protection	The output is at maximum capacity current of machine	Turn the machine off and back on again. If overcurrent protection alarm is still active, contact your suppliers approved technician.
E31	Undervoltage protection	The input mains voltage is too low	Turn the machine off and back on again. If the alarm continues, check the input voltage. If the input voltage is within specification and the alarm persists, contact your suppliers approved technician.
E32	Overvoltage protection	The input mains voltage is too high	Turn the machine off and back on again. If the alarm continues, check the input voltage. If the input voltage is within specification and the alarm persists, contact your suppliers approved technician.
E34	Undervoltage protection	Under voltage in inverter circuit	Turn the machine off and back on again. If the alarm continues, check the input voltage. If the input voltage is within specification and the alarm persists, contact your suppliers approved technician.
E60	Overheating	An over temperature signal received from the output rectifier circuit	Do not turn off the machine, wait for a while and after the thermal error goes off then you can continue welding. While error code is ON, machine cannot cut. Ensure cooling fans are operational. Decrease duty cycle welding activity.
E61	Overheating	An over temperature signal received from the Inverter IGBT circuit	Do not turn off the machine, wait for a while and after the thermal error goes off then you can continue welding. While error code is ON, machine cannot cut. Ensure cooling fans are operational. Decrease duty cycle welding activity.
	Abnormal VRD	VRD voltage is too high or too low	Turn the machine off and back on again. If the fault VRD alarm persists, contact your suppliers approved technician.

WEEE disposal

The equipment is manufactured with materials which do not contain any toxic or poisonous materials dangerous to the operator.

When the equipment is scrapped, it should be dismantled separating components according to the type of materials.

Do not dispose of the equipment with normal waste. The European Directive 2002/96/EC and United Kingdom's Directive The Waste Electrical and Electronic Equipment (WEEE) regulations 2013 states that electrical equipment that has reached its end of life must be collected separately and returned to an environmentally compatible recycling facility.

Jasic has a relevant recycling system which is compliant and registered in the UK with the environment agency. Our registration reference is WEEMM3813AA.

In order to comply with WEEE regulations outside the UK you should contact your supplier.

RoHS Compliance Declaration

We herewith confirm, that the above mentioned product does not contain any of the restricted substances as listed in EU Directive 2011/65/EU and the UK directive ROHS Regulations 2012 in concentrations above the limits as specified therein.

Disclaimer:

Please note that this confirmation is given to the best of our present knowledge and belief.

Nothing herein represents and/or may be interpreted as warranty within the meaning of the applicable warranty law.

UKCA Declaration of Conformity



UK DECLARATION OF CONFORMITY

The manufacturer or its legal representative Wilkinson Star Limited declares that the equipment listed described below is designed and produced according to the following UK directives:

Electrical equipment (Safety) regulations 2016	2016 No 1101
Electromagnetic compatibility regulations 2016	2016 No 1091
The restriction of the use of certain hazardous substances in electrical and electronic equipment regulations 2012	2012 No 3052
Requirements for welding equipment pursuant to the eco-design for energy related products and energy information regulations 2021	UK SI 2021/745

And inspected in compliance with the following harmonised standards

- BS EN 60974-1:2018 + A1:2019
- BS EN 60974-10:2014 + A1:2015
- BS EN 62822-1:2018
- BS EN 60974-5 2019

Any alteration or change to these machines by any unauthorised person makes this declaration invalid

WILKINSON STAR MODEL

- EM-160
- EM-200
- EM-200CT
- EM-250CT

JASIC MODEL

- MIG 160PFC N2S22
- MIG 200PFC N2S62
- MIG 200PFC N2S52
- MIG 250PFC N2SB2

Authorised Representative

Wilkinson Star Limited
 Shield Drive, Wardley Industrial Estate
 Worsley, Salford M28 2WD
 Tel +44 161 793 8127

Signature

Dr John A Wilkinson OBE
 Position Chairman

Date 23/11/2021



Manufacturer

Shenzhen Jasic Technology Co Ltd
 No3 Qinglan, 1st Road
 Pingshan District
 Shenzhen, China

Signature

Shenzhen Jasic Technology Co Ltd

Position

Date



Company Stamp



EC DECLARATION OF CONFORMITY



EU DECLARATION OF CONFORMITY

The manufacturer or its legal representative Wilkinson Star Limited declares that the equipment listed described below is designed and produced according to the following EU directives:

Low voltage directive (LVD)	2014/35/EU
Electromagnetic compatibility directive (EMC)	2014/30/EU
RoHS2	2011/65/EU
Annex 11 of RoHS2	2015/863
Eco design requirements for welding equipment pursuant 2009/125/EC	2019/1784

And inspected in compliance with the following harmonised standards

- EN 60974-1:2018 + A1:2019
- EN 60974-10:2014 + A1:2015
- EN 62822-1:2018
- EN 60974-5:2019

Any alteration or change to these machines by any unauthorised person makes this declaration invalid

WILKINSON STAR MODEL

- EM-160
- EM-200
- EM-200CT
- EM-250CT

JASIC MODEL

- MIG 160PFC N2S22
- MIG 200PFC N2S62
- MIG 200PFC N2S52
- MIG 250PFC N2SB2

Authorised Representative

Wilkinson Star Limited
Shield Drive, Wardley Industrial Estate
Worsley, Salford M28 2WD
Tel +44 161 793 8127

Signature

Dr John A Wilkinson OBE

Position

Chairman

Date



Company stamp

Manufacturer

Shenzhen Jasic Technology Co Ltd
No3 Qinglan, 1st Road
Pingshan District
Shenzhen, China

Signature

Shenzhen Jasic Technology Co Ltd

Position

Date

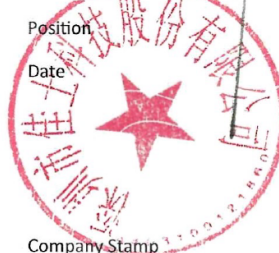

Company Stamp



STATEMENT OF WARRANTY

All new JASIC EVO2.0 welding, plasma cutters and multi-process machines are sold through our partner Wilkinson Star Limited within the United Kingdom and Ireland shall be warranted to the original owner, non transferable, against failure due to defective materials or production.

The warranty period is 5 years following the date of purchase and we recommend you register your product online within 28 days of purchase.

The original invoice is documentation for the standard warranty period. The warranty period is based on a single shift pattern.

Defective units shall be repaired or replaced by the company at our workshop. The company may opt to refund the purchase price (less any costs and depreciation due to use and wear).

The company reserves the right to alter the warranty conditions at any time with effect for the future.

A prerequisite for the full warranty is that products are operated in accordance with the operating instructions supplied, observing the relevant installation and any legal requirements recommendations and guidelines and carrying out the maintenance instructions shown in the operator manual. This should be carried out by a suitably qualified competent person.

Warranty claims will only be accepted from authorised Jasic distributors and in the unlikely event of a problem this should be reported to the technical support team to review the claim.

The customer has no claim to loan or replacement products whilst repairs are being performed.

The following falls outside the scope of the warranty:

- Defects due to natural wear and tear
- Failure to observe the operating and maintenance instructions
- Connection to an incorrect or faulty mains supply
- Overloading during use
- Any modifications that are made to the product without the prior written consent
- Software errors due incorrect operation
- Any repairs that are carried out using non-approved spare parts
- Any transport or storage damage
- Direct or indirect damage as well as any loss of earnings are not covered under the warranty
- External damage such as fire or damage due to natural causes e.g. flooding
- Warranty repairs carried out by non-authorized Jasic distributors.

NOTE: Under the terms of the warranty, welding torches, their consumable parts, wire feed unit drive rolls and guide tubes, work return cables and clamps, electrode holders, connection and extension cables, mains and control leads, plugs, wheels, coolant etc. are covered with a 3 month warranty.

Jasic shall in no event be responsible for any third party expenses or expenses/costs or any indirect or consequential expenses/costs.

Jasic will submit an invoice for any repair work performed outside the scope of the warranty. A quotation for any non warranty will be raised prior to any repairs being carried out.

The decision about repair or replacement of the defective part(s) is made by Jasic. The replaced part(s) remain(s) Jasic property.

Warranty extends only to the machine, its accessories and parts contained inside. No other warranty is expressed or implied. No warranty is expressed or implied in regards to the fitness of the product for any particular application or use.

If in our judgment you fail, or we suspect that you have failed, to comply with any term or provision of the product warranty terms, we reserve the right to deny you access to our services (or any part thereof).

For further information on Jasic product warranty terms and product warranty registration please visit:

www.jasic.co.uk/warranty-information

www.jasic.co.uk/warranty-registration

SCHEMATIC

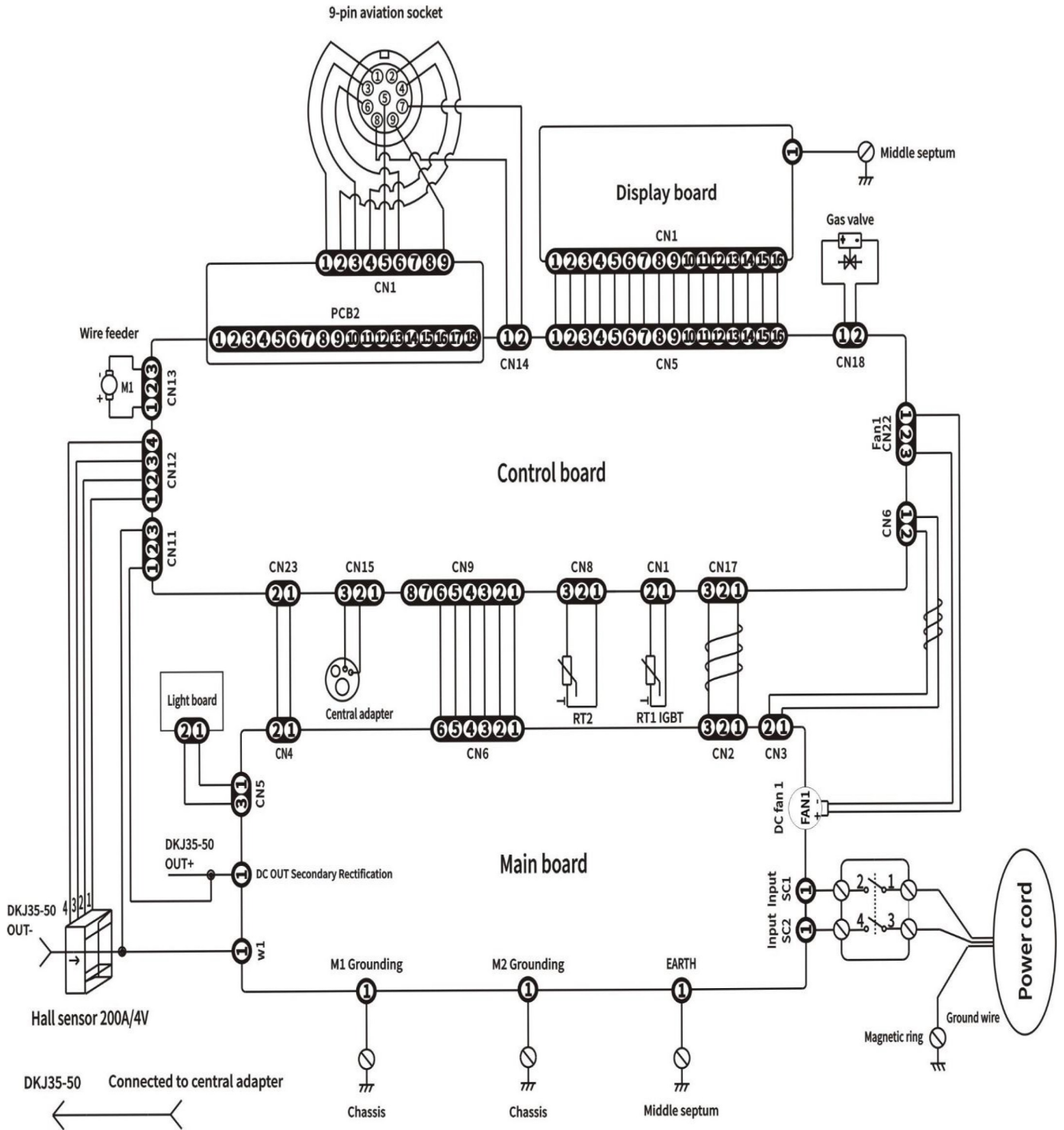





OPTIONS AND ACCESSORIES

Part Number	Description
JE250-3	250 MIG Torch 3mtr Euro
JE250-4	250 MIG Torch 4mtr Euro
WCS25-3WEL	Welding Cable Set (MMA) 3m
WC-2-03LD	Electrode Holder and lead 3m
EC-2-03LD	Work Return Lead and Clamp 3m
CP3550	Cable Plug 35-50mm
JE-SP250-6	Spool Gun SP250 6m
JH-HDX	Jasic HD True Colour Auto Darkening Welding Helmet
HRC-01	Wired hand held remote current control
HRC-02	Wireless hand held remote current control
FRC-01	Wired foot pedal remote current control
FRC-02	Wireless foot pedal remote current control
TS4	Wireless Transceiver
TFT-EM-200CT	Optional advanced TFT control screen
WP26-12JE	WP26 Euro Style TIG Torch 4m
Drive rolls for EM-200CT (2 roll drive) **	
10016540	Feed Roller 0.6mm/0.8mm "V" Groove
10031901 *	Feed Roller 0.8mm/1.0mm "V" Groove *
10031902	Feed Roller 1.0mm/1.2mm "V" Groove
10016541	Feed Roller 0.8mm/1.0mm "U" Groove
10029922	Feed Roller 1.0mm/1.2mm "U" Groove
10029929	Feed Roller 1.0mm/1.2mm FCW
10056664	"U" Groove 0.8mm/0.9mm
Drive rolls for EM-250CT (4 roll drive) **	
10055168	Feed Roller 0.6mm/0.8mm "V" Groove
10036428 *	Feed Roller 0.8mm/1.0mm "V" Groove *
10039481	Feed Roller 1.0mm/1.2mm "V" Groove
10029314	Feed Roller 1.2mm/1.6mm "V" Groove
10029899	Feed Roller 0.8mm/1.0mm "U" Groove
10016532	Feed Roller 1.0mm/1.2mm "U" Groove
10016599	Feed Roller 1.2mm/1.6mm "U" Groove
10029903	Feed Roller 1.2mm/1.6mm FCW
10029904	Feed Roller 1.0mm/1.6mm FCW

* Drive roll supplied with new machine

** **Please Note:** Drive rolls are supplied and sold in quantities of 1

OPTIONAL REMOTE CONTROL DEVICES

Control Type	Name	Model	Wireless Receiver	Welding Mode	Image
Wired	Wired foot pedal remote control	FRC-01	N/A	TIG	
	Wired handheld remote control	HRC-01	N/A	TIG/MMA	
Wireless	Wireless handheld remote control	HRC-02	Yes	TIG/MMA	
	Wireless Foot pedal remote control	FRC-02	Yes	TIG	
	Wireless Transceiver	TS4	Yes	TIG/MMA	N/A

NOTES



Wilkinson Star Limited

Shield Drive
Wardley Industrial Estate
Worsley
Manchester
UK
M28 2WD

+44(0)161 793 8127



Jasic.co.uk

 **JASIC®** | Passionate About Your Welding

www.jasic.co.uk

April 2023 Issue 1