



***PSF 260, PSF 315, PSF 315 RS3,
PSF 415, PSF 415 RS3,
PSF 420w, PSW 420w RS3,
PSF 430w, PSF 430w RS3,
PSF 515, PSF 520w,
PSF 520w RS3***



Instruction manual





EU DECLARATION OF CONFORMITY

According to
The Low Voltage Directive 2014/35/EU
The RoHS Directive 2011/65/EU

Type of equipment

MIG/MAG welding torch

Type designation

Air Cooled Variants: PSF 260, PSF 315, PSF 315 RS3, PSF 415, PSF 415 RS3, PSF 515
Water Cooled Variant: PSF 420w, PSF 420w RS3, PSF 430w, PSF 520w, PSF 520w RS3

Brand name or trademark

ESAB

Manufacturer or his authorised representative established within the EEA

Name, address, and telephone No:

ESAB AB
Lindholmsallén 9, Box 8004, SE-402 77 Göteborg, Sweden
Phone: +46 31 50 90 00, www.esab.com

The following harmonised standard in force within the EEA has been used in the design:

EN 60974-7:2013, Arc Welding Equipment - Part 7: Torches

By signing this document, the undersigned declares as manufacturer, or the manufacturer's authorised representative established within the EEA, that the equipment in question complies with the safety requirements stated above.

Date

Signature

Gothenburg 2020-10-09

A handwritten signature in black ink, appearing to read "Flavio Santos". The signature is stylized and cursive.

Flavio Santos
General Manager
Global Equipment Solutions

CE 2020

1	SAFETY	5
1.1	Meaning of symbols	5
1.2	Safety precautions	5
2	INTRODUCTION	8
3	SHIPMENT AND PACKAGING	9
4	TECHNICAL DATA	10
5	OPERATION	12
5.1	Fitting the liner.....	12
5.2	Equipping the torch.....	12
5.3	Fitting the central adaptor to the equipment	12
5.4	Connecting the cooling circuit.....	12
5.5	Setting the level of shielding gas.....	13
5.6	Checklist	13
5.7	Changing wire.....	13
5.8	Starting and stopping the welding process.....	13
6	MAINTENANCE	14
6.1	Overview	14
6.2	Cable assembly	14
6.3	Cleaning the wire feed	14
6.4	Steel liner / Plastic liner	14
6.5	Cleaning the swan neck.....	17
6.6	Checking the cooling system.....	17
7	TROUBLESHOOTING	18
8	ORDERING SPARE PARTS	19
	ORDERING NUMBERS	20
	SPARE PARTS LIST	22
	Torch neck PSF 260.....	22
	Torch neck PSF 315, PSF 415, PSF 415 straight, PSF 515	23
	Torch neck PSF 420w, 420w straight, PSF 430w, PSF 520w	25
	WEAR PARTS	27
	PSF 260	27
	PSF 315	28
	PSF 415	29
	PSF 515	30
	PSF 420w.....	31
	PSF 430w.....	32
	PSF 520w.....	33
	Contact tips PSF 260, PSF 315, PSF 415, PSF 515, PSF 420w, PSF 430w, PSF 520w.....	34
	Contact tips M6.....	35

TABLE OF CONTENTS

Steel liner **35**
PTFE liner..... **37**
PA Liner with bronze front end **37**

1 SAFETY

1.1 Meaning of symbols

As used throughout this manual: Means Attention! Be Alert!

**DANGER!**

Means immediate hazards which, if not avoided, will result in immediate, serious personal injury or loss of life.

**WARNING!**

Means potential hazards which could result in personal injury or loss of life.

**CAUTION!**

Means hazards which could result in minor personal injury.

**WARNING!**

Before use, read and understand the instruction manual and follow all labels, employer's safety practices and Safety Data Sheets (SDSs).



1.2 Safety precautions

Users of ESAB equipment have the ultimate responsibility for ensuring that anyone who works on or near the equipment observes all the relevant safety precautions. Safety precautions must meet the requirements that apply to this type of equipment. The following recommendations should be observed in addition to the standard regulations that apply to the workplace.

All work must be carried out by trained personnel well-acquainted with the operation of the equipment. Incorrect operation of the equipment may lead to hazardous situations which can result in injury to the operator and damage to the equipment.

1. Anyone who uses the equipment must be familiar with:
 - its operation
 - location of emergency stops
 - its function
 - relevant safety precautions
 - welding and cutting or other applicable operation of the equipment
2. The operator must ensure that:
 - no unauthorised person is stationed within the working area of the equipment when it is started up
 - no-one is unprotected when the arc is struck or work is started with the equipment
3. The workplace must:
 - be suitable for the purpose
 - be free from drafts

4. Personal safety equipment:
 - Always wear recommended personal safety equipment, such as safety glasses, flame-proof clothing, safety gloves
 - Do not wear loose-fitting items, such as scarves, bracelets, rings, etc., which could become trapped or cause burns
5. General precautions:
 - Make sure the return cable is connected securely
 - Work on high voltage equipment **may only be carried out by a qualified electrician**
 - Appropriate fire extinguishing equipment must be clearly marked and close at hand
 - Lubrication and maintenance must **not** be carried out on the equipment during operation

**WARNING!**

Arc welding and cutting can be injurious to yourself and others. Take precautions when welding and cutting.

**ELECTRIC SHOCK - Can kill**

- Install and ground the unit in accordance with instruction manual.
- Do not touch live electrical parts or electrodes with bare skin, wet gloves or wet clothing.
- Insulate yourself from work and ground.
- Ensure your working position is safe

**ELECTRIC AND MAGNETIC FIELDS - Can be dangerous to health**

- Welders having pacemakers should consult their physician before welding. EMF may interfere with some pacemakers.
- Exposure to EMF may have other health effects which are unknown.
- Welders should use the following procedures to minimize exposure to EMF:
 - Route the electrode and work cables together on the same side of your body. Secure them with tape when possible. Do not place your body between the torch and work cables. Never coil the torch or work cable around your body. Keep welding power source and cables as far away from your body as possible.
 - Connect the work cable to the workpiece as close as possible to the area being welded.

**FUMES AND GASES - Can be dangerous to health**

- Keep your head out of the fumes.
- Use ventilation, extraction at the arc, or both, to take fumes and gases away from your breathing zone and the general area.

**ARC RAYS - Can injure eyes and burn skin**

- Protect your eyes and body. Use the correct welding screen and filter lens and wear protective clothing.
- Protect bystanders with suitable screens or curtains.

**NOISE - Excessive noise can damage hearing**

Protect your ears. Use earmuffs or other hearing protection.

MOVING PARTS - Can cause injuries



- Keep all doors, panels and covers closed and securely in place. Have only qualified people remove covers for maintenance and troubleshooting as necessary. Reinstall panels or covers and close doors when service is finished and before starting engine.



- Stop engine before installing or connecting unit.
- Keep hands, hair, loose clothing and tools away from moving parts.

FIRE HAZARD



- Sparks (spatter) can cause fire. Make sure that there are no inflammable materials nearby.
- Do not use on closed containers.

MALFUNCTION - Call for expert assistance in the event of malfunction.

PROTECT YOURSELF AND OTHERS!



CAUTION!

This product is solely intended for arc welding.



WARNING!

Do not use the power source for thawing frozen pipes.



CAUTION!

Class A equipment is not intended for use in residential locations where the electrical power is provided by the public low-voltage supply system. There may be potential difficulties in ensuring electromagnetic compatibility of class A equipment in those locations, due to conducted as well as radiated disturbances.

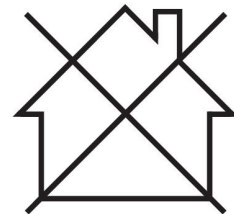

NOTE!

Dispose of electronic equipment at the recycling facility!

In observance of European Directive 2012/19/EC on Waste Electrical and Electronic Equipment and its implementation in accordance with national law, electrical and/or electronic equipment that has reached the end of its life must be disposed of at a recycling facility.

As the person responsible for the equipment, it is your responsibility to obtain information on approved collection stations.

For further information contact the nearest ESAB dealer.

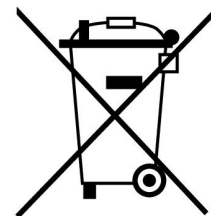

ESAB has an assortment of welding accessories and personal protection equipment for purchase. For ordering information contact your local ESAB dealer or visit us on our website.

2 INTRODUCTION

The MIG / MAG welding torches of this series are exclusively intended for shielded- arc welding using inert gas (MIG) or active gas (MAG) for industrial and commercial use by suitably trained employees. The torches are only available in manual versions.

3 SHIPMENT AND PACKAGING

The components are carefully checked and packaged, however damage may occur during shipping.

Checking procedure on receipt of goods

Check that the shipment is correct by referring to the shipping note.

In case of damage

Check the package and components for damage (visual inspection).

In case of complaints

If the package and/or components have been damaged during shipment:

- Contact with the last carrier immediately.
- Keep the packaging (for possible inspection by the carrier or supplier, or for returning the goods).

Storage in an enclosed space

Ambient temperature for shipment and storage: -20 °C to +55 °C

Relative air humidity: up to 90% at a temperature of 20 °C

4 TECHNICAL DATA

Welding torch	PSF 260	PSF 315, PSF 315 RS3	PSF 415, PSF 415 RS3	PSF 515
Type of cooling	Air	Air	Air	Air
Permitted load at 60% duty cycle*				
Carbon dioxide CO ₂	250 A	315 A	380 A	450 A
Mixed gas, Ar/CO ₂ M21	225 A	285 A	325 A	400 A
Recommended gas flow	8-12 l/min	8-15 l/min	10-18 l/min	10-20 l/min
Wire diameter	0.6-1.0 mm	0.8-1.2 mm	0.8-1.6 mm	1.0-1.6 mm
Operating temperature**	-10 °C to 40 °C	-10 °C to 40 °C	-10 °C to 40 °C	-10 °C to 40 °C

* The capacity may be reduced up to 30% when pulse welding.

Welding torch	PSF 420w, PSF 420w RS3, PSF 430w, PSF 430w RS3	PSF 520w, PSF 520w RS3
Type of cooling	Water	Water
Permitted load at 100% duty cycle*		
Carbon dioxide CO ₂	450 A	500 A
Mixed gas, Ar/CO ₂ M21	450 A	500 A
Recommended gas flow	10-20 l/min	10-20 l/min
Wire diameter	0.8-1.6 mm	1.0-1.6 mm
Operating temperature**	-10 °C to 40 °C	-10 °C to 40 °C

* The capacity may be reduced up to 30% when pulse welding.

** When using liquid cooled torches in freezing conditions, use an adequate cooling liquid.

Duty cycle

The duty cycle refers to the time as a percentage of a ten-minute period that you can weld at a certain load without overloading. The duty cycle is valid for 40 °C / 104 °F, or below.

General torch data with reference to IEC/EN 60 974-7	
Type of guidance:	Manual
Wire type:	Standard round wire
Voltage rating:	The control circuit and trigger switch are rated for a voltage of 42 V, max. 1 A
Specifications of the torch cooling circuit (for liquid cooled torches only):	<ul style="list-style-type: none"> • minimum flow 1.2 l/min • min. water pressure: 2.5 bar • max. water pressure: 3.5 bar • input temperature: max. 40 °C • return temperature: max. 60 °C • cooling capacity: min. 1000 W, up to 2000 W depending on the application

Liquid cooled torches

Return temperatures of more than 60 °C can shorten the lifetime of the torch or cause damage or destruction of the torch. The cooler must always be filled with sufficient cooling liquid, refer to the instruction manual for the cooling unit. In case of a high thermal load on the torch, use a cooler with sufficient capacity. Use only special cooling fluid containing corrosion inhibitors for welding torches. For suitable products, contact your nearest ESAB dealer.

The ratings are valid for cable lengths from 3.0 to 5.0 m.

The rated loads refer to a standardized case of use. Under special conditions, e.g. in case of high heat reflection on the torch, the torch could overheat even when operated below the rated load. In this case choose a more powerful model or lower the duty cycle.

Conditions of intended use

1. The welding torch should only be used within the above mentioned technical specifications and for its intended purpose.
2. The type of torch has to be chosen according to the welding application. The required duty-cycle and load, the type of cooling, guiding method and the wire diameter have to be considered. If increased requirements exist, for example caused by pre-heated work pieces, high heat reflection in corners, etc. these must be taken into account by choosing a welding torch with adequate reserve in rated load.
3. The product must be protected from humidity and moisture during transport, storage and operation.

5 OPERATION

General safety regulations for handling the equipment can be found in the "SAFETY" chapter of this manual. Read it through before you start using the equipment!



CAUTION!

This product is intended for industrial use. In a domestic environment this product may cause radio interference. It is the user's responsibility to take adequate precautions.



DANGER!

In the event of an emergency, the power supply must be switched off immediately. For further action in such circumstances, refer to the instruction manual for the power source for more information.

The welding torch can be used in any welding position.

Contact with hot items might cause damage to the torch and the cable assembly.

Do not drag the power source using the torch.

Do not pull the cable assembly over sharp edges. Do not bend the cable assembly sharply.

5.1 Fitting the liner

Fit the correct wire guide liner for the application, as needed to suit the wire type and diameter. See chapter "MAINTENANCE" section "Steel liner / Plastic liner".



NOTE!

For information on how to install new liners and about correct assembly procedure, see the chapter entitled "Maintenance"

Steel liner = for steel wires

Plastic liner = for aluminium, copper, nickel and stainless steel wires

5.2 Equipping the torch

The torch must be equipped according to the wire diameter and wire material. Choose the right liner, contact tip, tip adaptor, gas nozzle and gas diffuser (as applicable). A detailed overview of the suitable parts is found in the spare parts list for the torch.

Tighten the tip adaptor and the contact tip with an adequate tool.

Make sure that all required parts shown in the spare parts list, e.g. insulators, are installed. Welding without these items might cause immediate destruction of the torch.

5.3 Fitting the central adaptor to the equipment

1. Check that the wire guide liner is fitted correctly.
2. Insert the central plug into the socket on the wire feed unit and secure it by tightening the adaptor nut firmly by hand.

5.4 Connecting the cooling circuit

Connect the water hoses to the cooling unit: blue for water flow forward from the cooler to the torch; red for heated water flow backwards from the torch to the cooler. Before using a water

cooled torch, the air has to be removed from the cooling circulation by running the cooler for a few minutes.

**CAUTION!**

Wrongly connected water hoses can cause overheating and damage of the torch neck and water-power cable. Regularly check the coolant level and throughput on the cooling unit. Insufficient cooling might cause overheating and damage of the torch neck and water-power cable.

**NOTE!**

To achieve an optimal gas- and water flow, place the cable assemblies and the gas and water hoses as straight as possible. Kinked hoses will cause overheating and can damage the torch. Protect cables and supply hoses from damage.

5.5 Setting the level of shielding gas

Set the quantity of gas required on the gas regulator. The type and quantity of gas to be used depend on the welding task to be performed.

5.6 Checklist

Check the cable assembly before connecting it to the wire feed unit to confirm the wire liner is suitable for the wire diameter and type.

Check the front end consumable parts on the swan neck, whether the correct contact tip etc. is being used for the wire diameter and type.

5.7 Changing wire

When changing the wire, ensure that the end of the wire is deburred.

Insert the wire into the wire feeding unit in accordance with the operating instructions.

When inserting the wire, press the wire jog button on the wire feed unit.

5.8 Starting and stopping the welding process

The wire feeder and the welding process will be started by pulling the torch trigger. Depending on the configuration of the welding machine, the welding process will be stopped by either letting go of the trigger or by pulling the trigger a second time. Refer to the instruction manual for the power source for more information.

**DANGER!**

The torch head might reach very high temperatures during operation, there is a risk of severe burns. Let it cool down under observation, there is risk of fire. Do not place the hot torch on or near heat-sensitive objects. For water cooled torches, the cooling system should remain switched on for some minutes after the welding process has been stopped.

When leaving the workplace the system must be secured against unintended operation, preferably by switching off the power source.

6 MAINTENANCE

6.1 Overview

**NOTE!**

Regular maintenance is important for safe and reliable operation.

Cleaning and replacement of the welding torch's wear parts should take place at regular intervals in order to achieve trouble-free wire feed. Blow the wire guide clean regularly and clean the contact tip.

**WARNING!**

Before carrying out cleaning, servicing and repair work, the following shutdown procedure must be followed.

1. Switch off the power supply.
2. Close off the gas supply.

Make sure that the power supply and gas remain turned off all the time while servicing the equipment.

6.2 Cable assembly

Check the torch and cable assembly for damages prior to use. Damages must be repaired by qualified personnel before further use of the product.

6.3 Cleaning the wire feed

Disconnect the torch cable assembly from the equipment and lay it out straight.

Unscrew the nut and pull out the wire guide liner. Remove other parts from the swan neck.

Blow compressed air through the wire conduit from both ends in order to remove wire shavings.

Insert the liner into the wire conduit and screw the nut back on.

**NOTE!**

New liners must be cut to the correct length.

6.4 Steel liner / Plastic liner

If a wire feeding problem cannot be solved by exchanging the contact tip and cleaning the wire guide channel, the liner should be replaced.

Liner and welding wire should be inserted while the cable assembly is laid out straight.

Installing a steel liner

1. Remove the sleeve nut from the central connector, remove the gas nozzle, contact tip and tip holder from the torch.
2. Insert the liner through the central connector and lock it with the sleeve nut.
3. Gently push back the front part of the liner into the torch as far as it will go, do not apply force. Mark the end of the torch neck on the liner.
4. Cut the liner to the correct length using a projectile "X" measured from the marking as shown in the figure.

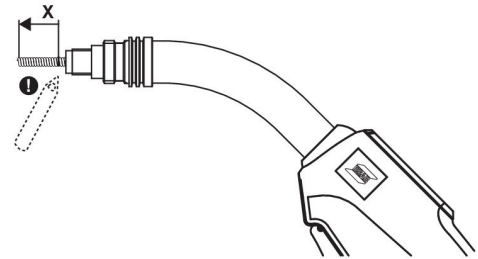
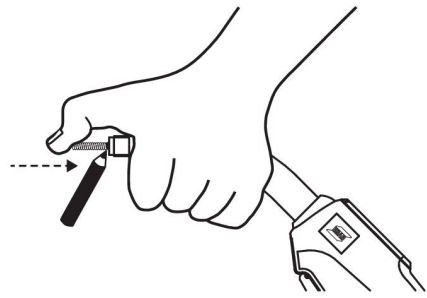

Remove the liner from the torch and carefully smoothen its front end. If needed, grind down burred edges. Make sure the inner hole is completely open.

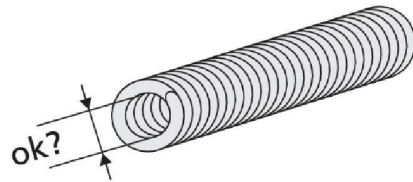

For insulated liners, remove the insulation at the front end so that the remaining insulation ends approximately at the front end of the torch handle.

Reinstall the liner and lock it with the sleeve nut. Install all equipment parts on the torch neck.

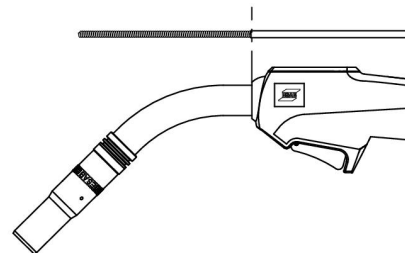

Cutting length

Welding torch	Projectile "X"
PSF 260	16 mm
PSF 315, PSF 315 RS3	16 mm
PSF 415, PSF 415 RS3	12 mm
PSF 515	17 mm
PSF 420w, PSF 420w RS3, PSF 430w, PSF 430w RS3	12 mm
PSF 520w, PSF 520w RS3	12 mm

Installing a plastic liner

1. Remove the sleeve nut from the central connector, remove the gas nozzle, contact tip and tip holder from the torch.
2. Insert the liner through the central connector and lock it with the sleeve nut.
3. Gently push back the front part of the liner into the torch as far as it will go, do not apply force. Mark the end of the torch neck on the liner.
4. Cut the liner to the correct length using a projectile "X" measured from the marking as shown in the figure. Slightly chamfer the liner front end after the liner has been cut to the correct length.

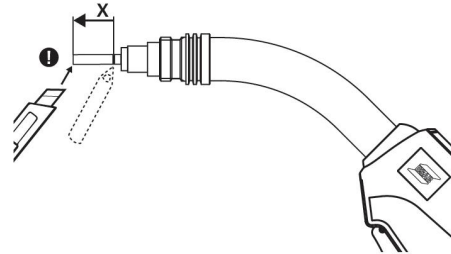
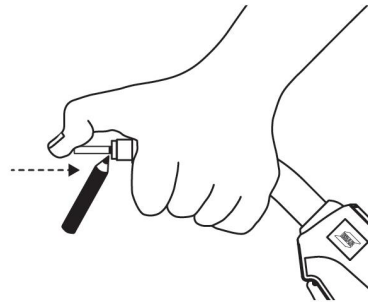

NOTE!

If the liner has a bronze front end, first cut the plastic liner to a suitable length and let the bronze liner stick out approximately 40-50 mm from the torch neck. Attach the bronze liner to the front of the plastic liner and only then cut this liner assembly to the precise length.

If it is difficult to insert the liner into the torch, make a clean cut at the front end of the liner and chamfer the edges (e.g. with a pencil sharpener).



Install all equipment parts on the torch neck.

Cutting length

Welding torch	Projectile "X"
PSF 260	13 mm
PSF 315, PSF 315 RS3	13 mm
PSF 415, PSF 415 RS3	9 mm
PSF 515	14 mm
PSF 420w, PSF 420w RS3, PSF 430w, PSF 430w RS3	9 mm
PSF 520w, PSF 520w RS3	9 mm

6.5 Cleaning the swan neck

- Clean the inside of the gas nozzle regularly to remove welding spatter and spray with ESAB® anti-spatter agent.
- Check the consumables for visible damage and replace if necessary.

6.6 Checking the cooling system

Make sure that the cooling liquid is clean, change it if required. Impurities in the cooling liquid can obstruct the torch water channels. Always use suitable cooling fluid for torches with corrosion inhibitors.

7 TROUBLESHOOTING

If the measures described below are not successful, consult your dealer or the manufacturer. Read the operating instructions for the welding components, e.g. power source and wire feed unit.

Problem	Possible cause	Action
Torch becomes too hot	<ul style="list-style-type: none"> • Contact tip / tip holder not tight enough • Cooling system is not working well • Torch overstrained • Cable assembly defective 	<ul style="list-style-type: none"> • Check and tighten hand-tight • Check water flow, filling level and cleanliness • Observe technical data, if needed, choose a different type • Check cables, tubes and connections
Wire feeding problems	<ul style="list-style-type: none"> • Contact tip is worn • Liner is worn / dirty • Consumables used are not suitable for the wire diameter or material • Wire feeder not set-up properly • Cable assembly is bent or laid out in small radii • Wire is contaminated 	<ul style="list-style-type: none"> • Exchange contact tip • Check the liner, blow through in both directions. Exchange if needed. • Check with spare part list • Check the wire feeding rolls, the contact pressure and the spool brake • Check the cable assembly and lay it out straight • Use a cleaning felt
Porous welds	<ul style="list-style-type: none"> • Gas swirl caused by spatter adherence • Too small or extremely high gas flow in the torch • Gas supply defective • Air draft at the work place • Moisture or contamination on the wire or on the work piece 	<ul style="list-style-type: none"> • Clean the torch head, use gas diffuser / spatter protection • Check flow rate with measurement tool • Check flow rate and possible leakage • Install shielding • Check the wire and the work piece, use less or different anti-spatter liquid
Variable arc	<ul style="list-style-type: none"> • Contact tip is worn • Wrong welding parameters 	<ul style="list-style-type: none"> • Exchange contact tip • Correct the welding parameters
Welding process does not start	<ul style="list-style-type: none"> • Control cable is broken or the trigger is defective 	<ul style="list-style-type: none"> • Check and repair the trigger connections, clean the trigger switch or exchange it

8 ORDERING SPARE PARTS



CAUTION!

Repair and electrical work should be performed by an authorised ESAB service technician. Use only ESAB original spare and wear parts.

The PSF 260, PSF 315, PSF 415, PSF 515, PSF 420w, PSF 430w and PSF 520w are designed and tested in accordance with international and European standards **IEC/EN 60974-7**. On completion of service or repair work, it is the responsibility of the person(s) performing the work to ensure that the product still complies with the requirements of the above standard.

Spare parts and wear parts can be ordered through your nearest ESAB dealer, see esab.com. When ordering, please state product type, serial number, designation and spare part number in accordance with the spare parts list. This facilitates dispatch and ensures correct delivery.

ORDERING NUMBERS



Ordering number	Denomination	Type	Notes
Gas cooled torches			
0700 025 020	PSF 260	Welding torch 3 m	Euro-Central connector
0700 025 021	PSF 260	Welding torch 4 m	Euro-Central connector
0700 025 022	PSF 260	Welding torch 5 m	Euro-Central connector
0700 025 030	PSF 315	Welding torch 3 m	Euro-Central connector
0700 025 031	PSF 315	Welding torch 4 m	Euro-Central connector
0700 025 032	PSF 315	Welding torch 5 m	Euro-Central connector
0700 025 033	PSF 315 RS3	Welding torch 4 m	Euro-Central connector
0700 025 037	PSF 315 RS3	Welding torch 5 m	Euro-Central connector
0700 025 040	PSF 415	Welding torch 3 m	Euro-Central connector
0700 025 041	PSF 415	Welding torch 4 m	Euro-Central connector
0700 025 042	PSF 415	Welding torch 5 m	Euro-Central connector
0700 025 043	PSF 415 RS3	Welding torch 4 m	Euro-Central connector
0700 025 050	PSF 515	Welding torch 3 m	Euro-Central connector
0700 025 051	PSF 515	Welding torch 4 m	Euro-Central connector
0700 025 052	PSF 515	Welding torch 5 m	Euro-Central connector
Water cooled torches			
0700 025 060	PSF 420w	Welding torch 3 m	Euro-Central connector
0700 025 061	PSF 420w	Welding torch 4 m	Euro-Central connector
0700 025 062	PSF 420w	Welding torch 5 m	Euro-Central connector
0700 025 063	PSF 420w RS3	Welding torch 3 m	Euro-Central connector
0700 025 064	PSF 420w RS3	Welding torch 4 m	Euro-Central connector
0700 025 065	PSF 420w RS3	Welding torch 5 m	Euro-Central connector
0700 025 076	PSF 430w	Welding torch 3 m	Euro-Central connector
0700 025 077	PSF 430w	Welding torch 4 m	Euro-Central connector

ORDERING NUMBERS

Ordering number	Denomination	Type	Notes
0700 025 078	PSF 430w	Welding torch 5 m	Euro-Central connector
0700 025 085	PSF 430w RS3	Welding torch 3 m	Euro-Central connector
0700 025 086	PSF 430w RS3	Welding torch 4 m	Euro-Central connector
0700 025 087	PSF 430w RS3	Welding torch 5 m	Euro-Central connector
0700 025 070	PSF 520w	Welding torch 3 m	Euro-Central connector
0700 025 071	PSF 520w	Welding torch 4 m	Euro-Central connector
0700 025 072	PSF 520w	Welding torch 5 m	Euro-Central connector
0700 025 073	PSF 520w RS3	Welding torch 3 m	Euro-Central connector
0700 025 074	PSF 520w RS3	Welding torch 4 m	Euro-Central connector

SPARE PARTS LIST

Torch neck PSF 260

Item	Ordering no.	Denomination
100	0700 025 000	Torch neck PSF 260
101	0700 025 908	Plastic nut
102	0700 025 900	Handle cpl. Expert Mini
103	0700 025 903	Trigger, yellow, 2-poles
104	0700 025 904	Screw for handle
105	0700 025 950	Cable support cpl., small, G
106	0700 025 951	Adaptor nut
107	0700 200 101	Central connector G
108	0700 200 098	Liner locking nut
109	0700 025 952	Cylinder head screw M4 × 6
110	0700 025 953	O-ring 4.0 × 1.0 mm
111	0700 025 954	Coaxial cable for PSF 260, 3 m
	0700 025 955	Coaxial cable for PSF 260, 4 m
	0700 025 956	Coaxial cable for PSF 260, 5 m

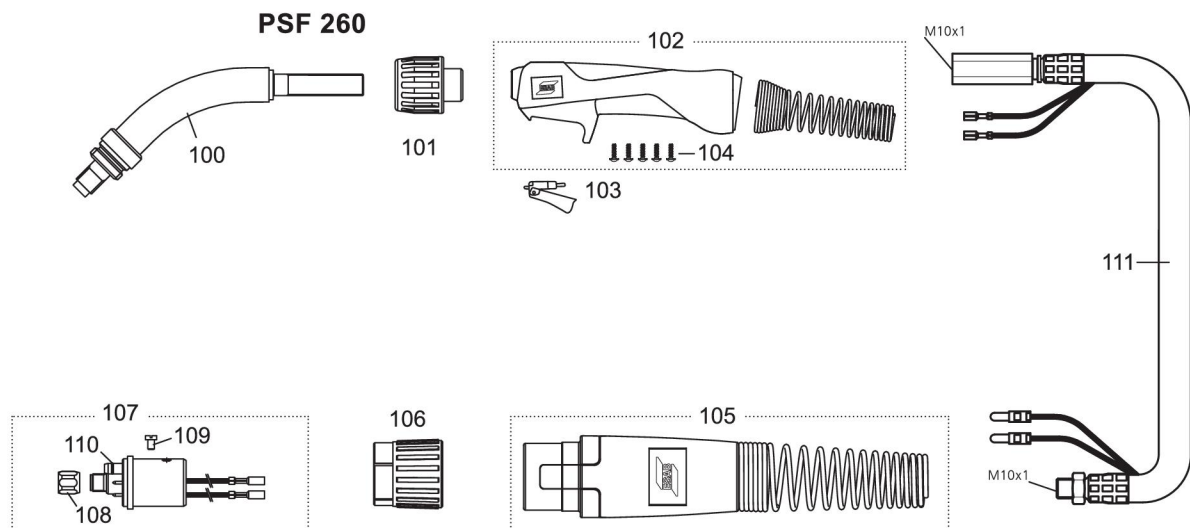

Torch neck PSF 315, PSF 415, PSF 415 straight, PSF 515

Item	Ordering no.	Denomination	PSF 315	PSF 415	PSF 515
200	0700 025 001	Torch neck PSF 315	X		
201	0700 025 002	Torch neck PSF 415		X	
201a	0700 025 009	Torch neck PSF 415 straight		X	
202	0700 025 003	Torch neck PSF 515			X
203	0700 025 905	Handle cpl. Expert Plus	X	X	
204	0700 025 906	Handle cpl. Expert Plus			X
205	0700 025 903	Trigger, yellow, 2-poles	X	X	X
206	0700 025 904	Screw for handle	X	X	X
207	0700 025 907	Cable support cpl., large, G	X	X	X
208	0700 025 951	Adaptor nut	X	X	X
209	0700 200 101	Central connector G	X	X	X
210	0700 200 098	Liner locking nut	X	X	X
211	0700 025 952	Cylinder head screw M4 × 6	X	X	X
212	0700 025 953	O-ring 4.0 × 1.0 mm	X	X	X
213	0700 025 964	Coaxial cable, 3 m	X		
	0700 025 965	Coaxial cable, 4 m	X		
	0700 025 966	Coaxial cable, 5 m	X		
	0700 025 957	Coaxial cable, 3 m		X	
	0700 025 958	Coaxial cable, 4 m		X	
	0700 025 959	Coaxial cable, 5 m		X	
	0700 025 967	Coaxial cable, 3 m			X
	0700 025 968	Coaxial cable, 4 m			X
	0700 025 969	Coaxial cable, 5 m			X
214	0700 025 850	Modul ESAB RS3	X	X	

SPARE PARTS LIST

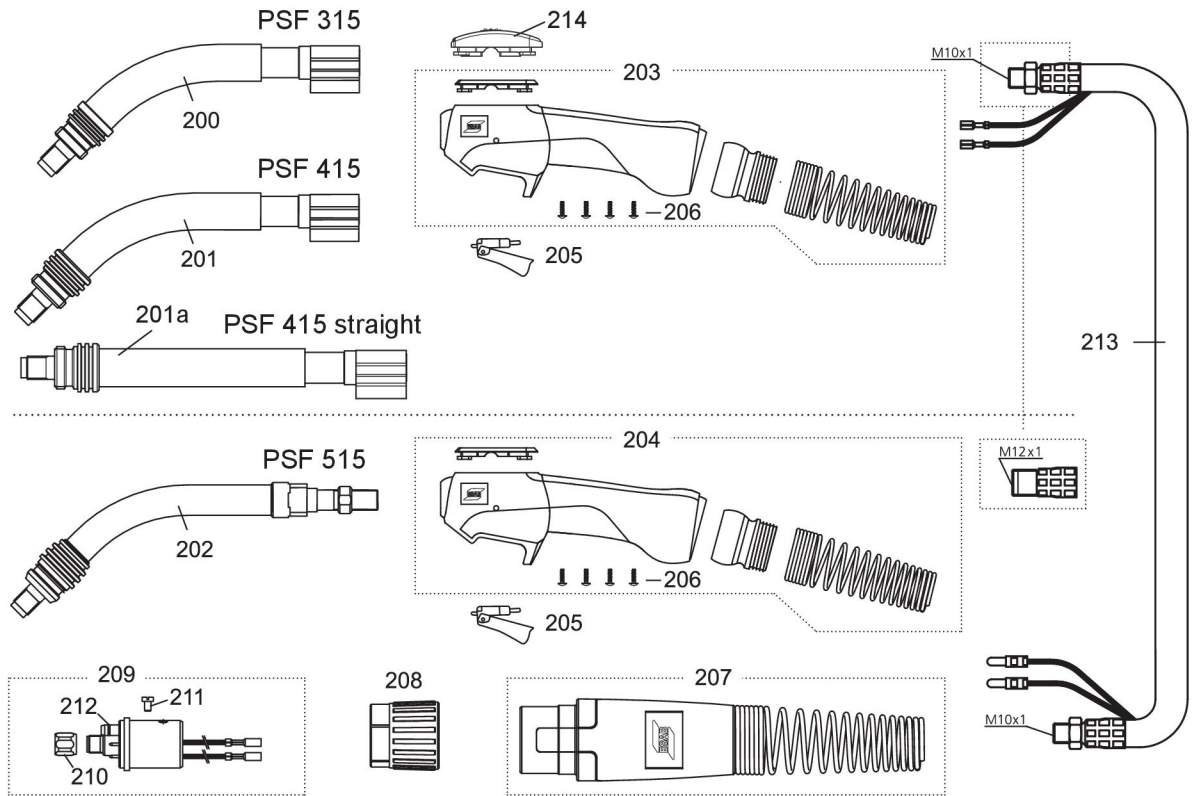

Torch neck PSF 420w, 420w straight, PSF 430w, PSF 520w

Item	Ordering no.	Denomination	PSF 420w	PSF 430	PSF 520w
300	0700 025 004	Torch neck PSF 420w	X		
300a	0700 025 010	Torch neck PSF 420w straight	X		
300b	0700 025 011	Torch neck PSF 430w		X	
301	0700 025 005	Torch neck PSF 520w			X
302	0700 025 905	Handle cpl. Expert Plus	X		
303	0700 025 906	Handle cpl. Expert Plus		X	X
304	0700 025 903	Trigger, yellow, 2-poles	X	X	X
305	0700 025 904	Screw for handle	X	X	X
306	0700 025 971	Cable support cpl.	X	X	X
307	0700 025 973	Quick connector	X	X	X
308	0700 025 975	Hose clamp with ring Ø 9.0	X	X	X
309	0700 025 951	Adaptor nut	X	X	X
310	0700 025 970	Central connector W	X	X	X
311	0700 200 098	Liner locking nut	X	X	X
312	0700 025 952	Cylinder head screw M4 × 6	X	X	X
313	0700 025 953	O-ring 4.0 × 1.0 mm	X	X	X
314	0700 025 974	Hose clamp with ring Ø 8.7	X	X	X
315	0700 025 976	Hose clamp with ring Ø 9.5	X	X	X
316	0700 025 972	Clamping ring for outer cover	X	X	X
317	0700 025 993	PVC-Gas hose, black, 4.5 × 1.5 mm	X	X	X
318	0700 025 994	PVC hose, braided, black, 5 × 1.5 mm	X	X	X
319	0700 025 992	Fabric outer cover	X	X	X
324	0700 025 850	Modul ESAB RS3	X	X	X

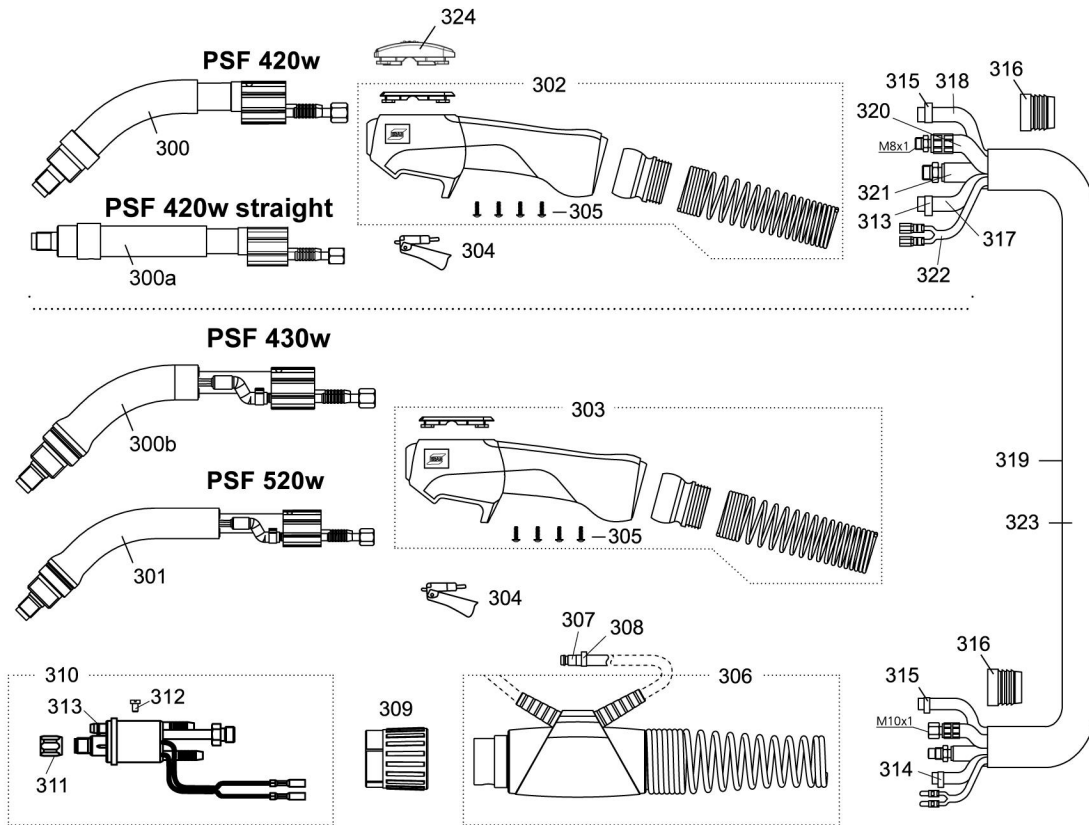

Item	Ordering no. / 3 m	Ordering no. / 4 m	Ordering no. / 5 m	Denomination
320	0700 025 983	0700 025 984	0700 025 985	Water-power cable
321	0700 025 986	0700 025 987	0700 025 988	Wire conduit
322	0700 025 989	0700 025 990	0700 025 991	Control cable cpl.
323	0700 025 980	0700 025 981	0700 025 982	Cable assembly



WEAR PARTS

PSF 260

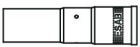
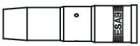
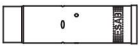
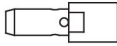
Bold = standard delivery. For contact tip, see contact tips table.



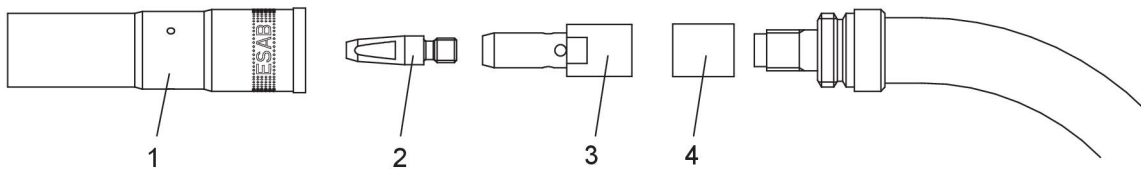

Ordering no.	Denomination	Notes	Ø	Length	
0458 464 881	Gas nozzle	Standard	14 mm	73 mm	
0458 465 881	Gas nozzle	Conical	12 mm	73 mm	
0458 470 881	Gas nozzle	Straight	16 mm	73 mm	
0366 314 001	Tip adaptor standard M6			36.6 mm	
0366 397 001	Insulation bushing				

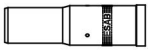
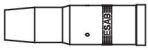

- | | |
|------------------------|-----------------------|
| 1. Gas nozzle | 3. Tip adaptor M6 |
| 2. Contact tip M6 × 27 | 4. Insulation bushing |

PSF 315

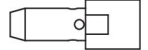
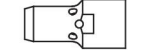
Bold = standard delivery. For contact tip, see contact tips table.



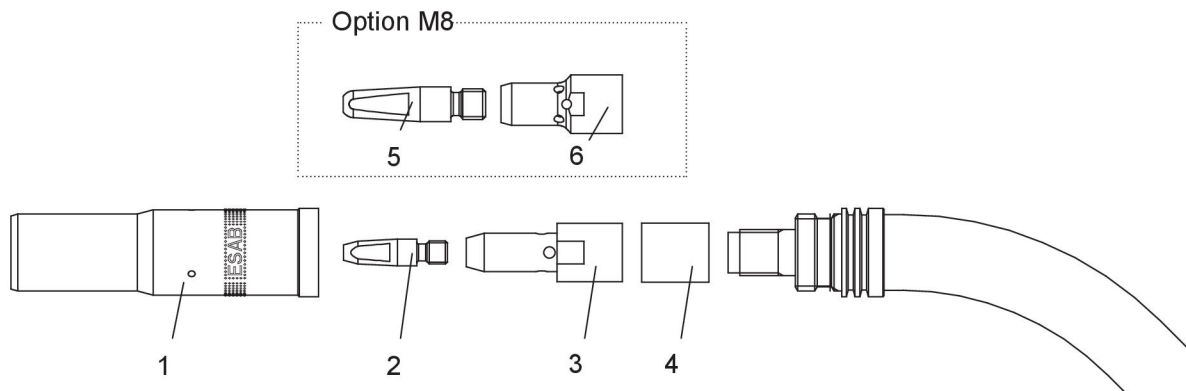

Ordering no.	Denomination	Notes	Ø	Length	
0458 464 882	Gas nozzle	Standard	16 mm	80 mm	
0458 465 882	Gas nozzle	Conical	14 mm	80 mm	
0458 470 882	Gas nozzle	Straight	19 mm	80 mm	
0366 394 001	Tip adaptor M6			40.6 mm	
0460 819 001	Tip adaptor M8 CU			31.6 mm	
0700 025 851	Tip adaptor M8 brass			31.6 mm	
0366 397 002	Insulation bushing				

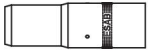
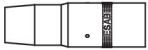

- | | |
|------------------------|------------------------|
| 1. Gas nozzle | 4. Insulation bushing |
| 2. Contact tip M6 × 27 | 5. Contact tip M8 × 37 |
| 3. Tip adaptor M6 | 6. Tip adaptor M8 |

PSF 415

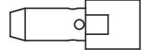
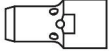
Bold = standard delivery. For contact tip, see contact tips table.



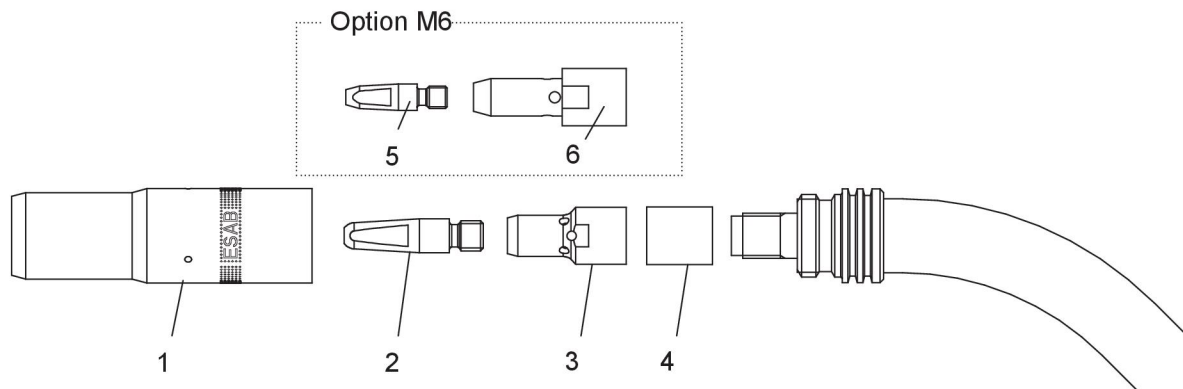

Ordering no.	Denomination	Notes	Ø	Length	
0458 464 883	Gas nozzle	Standard	17 mm	80 mm	
0458 465 883	Gas nozzle	Conical	15 mm	80 mm	
0458 470 883	Gas nozzle	Straight	21 mm	80 mm	
0366 394 001	Tip adaptor M6			40.6 mm	
0460 819 001	Tip adaptor M8 Cu			31.6 mm	
0700 025 851	Tip adaptor M8 brass			31.6 mm	
0366 397 002	Insulation bushing				

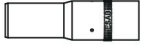

- | | |
|------------------------|------------------------|
| 1. Gas nozzle | 4. Insulation bushing |
| 2. Contact tip M8 × 37 | 5. Contact tip M6 × 27 |
| 3. Tip adaptor M8 | 6. Tip adaptor M6 |

PSF 515

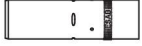
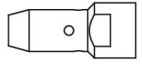
Bold = standard delivery. For contact tip, see contact tips table.



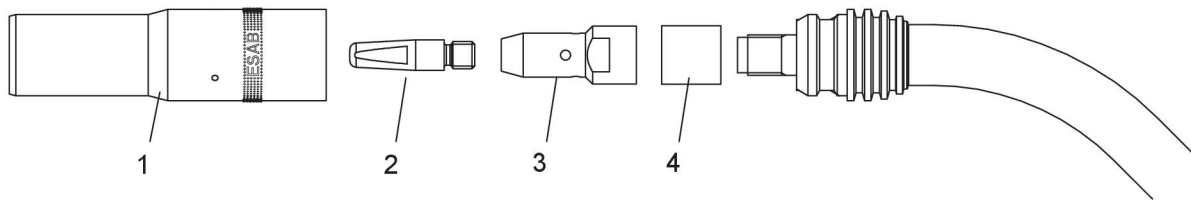

Ordering no.	Denomination	Notes	Ø	Length	
0458 464 884	Gas nozzle	Standard	18 mm	94 mm	
0458 465 884	Gas nozzle	Conical	15 mm	94 mm	
0458 470 884	Gas nozzle	Straight	21 mm	94 mm	
0366 395 001	Tip adaptor standard M8 Cu			40.1 mm	
0700 025 852	Tip adaptor M8 brass			40.1 mm	
0366 397 003	Insulation bushing				

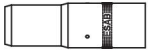

- | | |
|------------------------|-----------------------|
| 1. Gas nozzle | 3. Tip adaptor M8 |
| 2. Contact tip M8 × 27 | 4. Insulation bushing |

PSF 420w

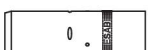
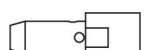
Bold = standard delivery. For contact tip, see contact tips table.



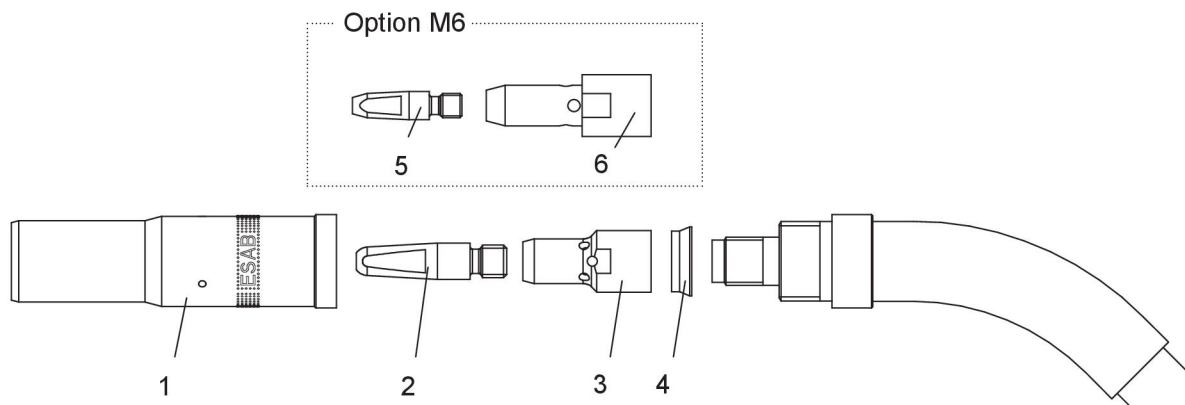

Ordering no.	Denomination	Notes	Ø	Length	
0458 464 882	Gas nozzle	Standard	16 mm	80 mm	
0458 465 882	Gas nozzle	Conical	14 mm	80 mm	
0458 470 882	Gas nozzle	Straight	19 mm	80 mm	
0366 394 001	Tip adaptor M6			40.6 mm	
0460 819 001	Tip adaptor M8 Cu			31.6 mm	
0700 025 851	Tip adaptor M8 brass			31.6 mm	
0458 874 001	Insulation washer				

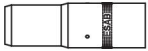
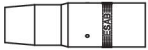

- | | |
|------------------------|------------------------|
| 1. Gas nozzle | 4. Insulation washer |
| 2. Contact tip M8 × 37 | 5. Contact tip M6 × 27 |
| 3. Tip adaptor M8 | 6. Tip adaptor M6 |

PSF 430w

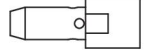
Bold = standard delivery. For contact tip, see contact tips table.



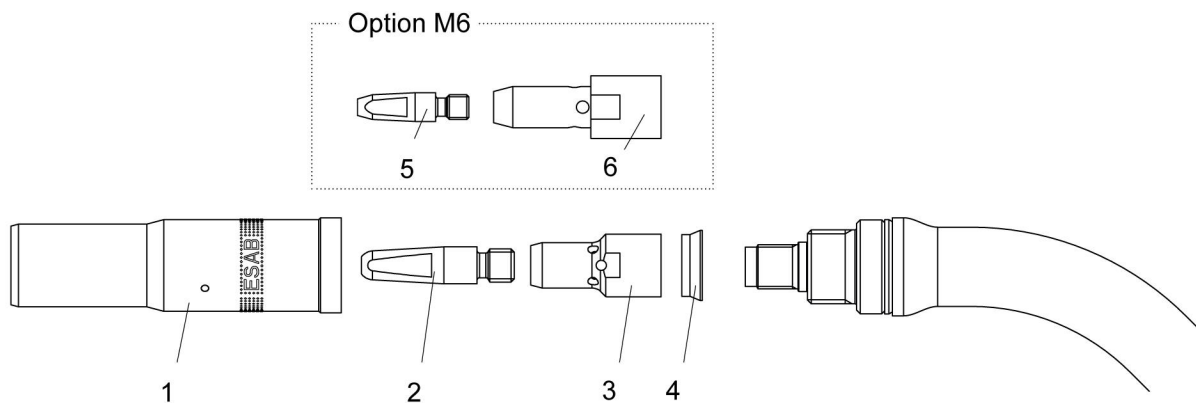

Ordering no.	Denomination	Notes	Ø	Length	
0458 464 882	Gas nozzle	Standard	16 mm	80 mm	
0458 465 882	Gas nozzle	Conical	14 mm	80 mm	
0458 470 882	Gas nozzle	Straight	19 mm	80 mm	
0366 394 001	Tip adaptor M6			40.6 mm	
0460 819 001	Tip adaptor M8 Cu			31.6 mm	
0700 025 851	Tip adaptor M8 brass			31.6 mm	
0458 874 001	Insulation washer				

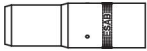

- | | |
|------------------------|------------------------|
| 1. Gas nozzle | 4. Insulation washer |
| 2. Contact tip M8 × 37 | 5. Contact tip M6 × 27 |
| 3. Tip adaptor M8 | 6. Tip adaptor M6 |

PSF 520w

Bold = standard delivery. For contact tip, see contact tips table.

Ordering no.	Denomination	Notes	Ø	Length	
0458 464 883	Gas nozzle	Standard	17 mm	80 mm	
0458 465 883	Gas nozzle	Conical	15 mm	80 mm	
0458 470 883	Gas nozzle	Straight	21 mm	80 mm	
0460 819 001	Tip adaptor M8 Cu			31.6 mm	
0700 025 851	Tip adaptor M8 brass			31.6 mm	
0458 874 001	Insulation washer				

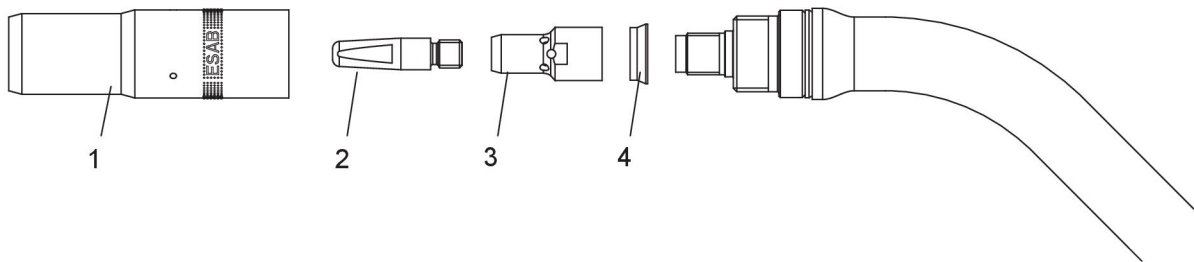

1. Gas nozzle
2. Contact tip M8 × 37

3. Tip adaptor M8
4. Insulation washer

Contact tips PSF 260, PSF 315, PSF 415, PSF 515, PSF 420w, PSF 430w, PSF 520w

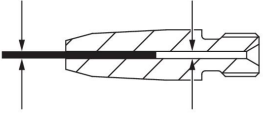
PSF 260* / PSF 315	PSF 415 / PSF 420w / PSF 430w	Gas / wire Ø		
		CO ₂	Mix/Ar	
M6	M6	CO₂	Mix/Ar	M6
0468 500 001	0468 500 001	0.6	-	W0.6 / 0.8
0468 500 002	0468 500 002	-	0.6	W0.8 / 0.9
0468 500 003	0468 500 003	0.8	-	W0.8 / 1.0
0468 500 004	0468 500 004	0.9	0.8	W0.9 / 1.1
0468 500 005	0468 500 005	1.0	0.9	W1.0 / 1.2
0468 500 006	0468 500 006	1.2	-	W1.2 / 1.4
0468 500 007	0468 500 007	1.2	1.0	W1.2 / 1.5
0468 500 008	0468 500 008	1.4	1.2	W1.4 / 1.7
-	0468 500 009	1.6	-	W1.6 / 1.9
-	0468 500 010	-	1.6	W1.6 / 2.1

*PSF 260 only for M6 and wire 0.6 – 1.0

M6 × 27

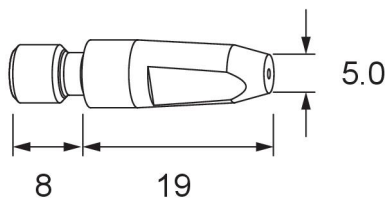

M8 × 37

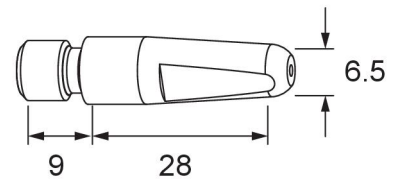

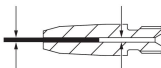
PSF 315	PSF 415 / PSF 420w / PSF 430w	PSF 515 / PSF 520w	Gas / wire Ø		
			CO ₂	Mix/Ar	
M8	M8	M8	CO₂	Mix/Ar	M8
0468 502 003	0468 502 003	0468 502 003	0.8	-	W0.8 / 1.0
0468 502 004	0468 502 004	0468 502 004	0.9	0.8	W1.0 / 1.1
0468 502 005	0468 502 005	0468 502 005	1.0	0.9	W1.0 / 1.2
0468 502 006	0468 502 006	0468 502 006	1.2	-	W1.2 / 1.4
0468 502 007	0468 502 007	0468 502 007	1.2	1.0	W1.2 / 1.5
0468 502 008	0468 502 008	0468 502 008	1.4	1.2	W1.4 / 1.7
-	0468 502 009	0468 502 009	1.6	-	W1.6 / 1.9
-	0468 502 010	0468 502 010	-	1.6	W1.6 / 2.1

Contact tips M6

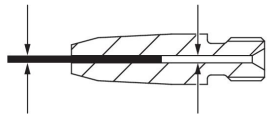
Contact tip	Gas / wire Ø		
	CO ₂	Mix/Ar	
0468 501 002	-	0.6	W0.8 / 1.0
0468 501 003	0.8	-	W0.9 / 1.1
0468 501 004	0.9	0.8	W1.0 / 1.2
0468 501 005	1.0	0.9	W1.2 / 1.5

Nib M6

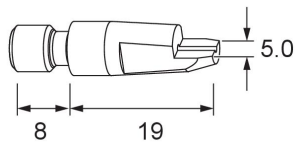

Steel liner

Bold = standard delivery

Ordering no.	Ø	Length	Notes	PSF 260	PSF 315	PSF 415 PSF 515	PSF 420w PSF 430w	PSF 520w
0700 200 085	0.8– 1.0	3 m	Blue	X	X			
0700 200 086	0.8– 1.0	4 m	Blue	X	X			
0700 025 800	0.8– 1.0	5 m	Blue	X	X			
0700 200 087	1.0– 1.2	3 m	Red	X	X			
0700 200 088	1.0– 1.2	4 m	Red	X	X			
0700 025 801	1.0– 1.2	5 m	Red	X	X			
0700 025 822	0.9– 1.2	3 m	Red H D			X	X	X
0700 025 823	0.9– 1.2	4 m	Red H D			X	X	X
0700 025 824	0.9– 1.2	5 m	Red H D			X	X	X
0700 025 825	1.4– 1.6	3 m	Grey HD			X	X	X
0700 025 826	1.4– 1.6	4 m	Grey HD			X	X	X
0700 025 827	1.4– 1.6	5 m	Grey HD			X	X	X

WEAR PARTS

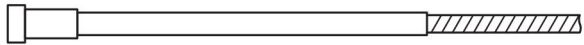

PTFE liner

Ordering no.	Ø	Length	Notes	PSF 260	PSF 315	PSF 415	PSF 515	PSF 420w, PSF 430w, PSF 520w
0700 200 089	0.8–1.0	3 m	Blue	X	X	X	X	X
0700 200 090	0.8–1.0	4 m	Blue	X	X	X	X	X
0700 025 811	0.8–1.0	5 m	Blue	X	X	X	X	X
0700 200 091	1.0–1.2	3 m	Red	X	X	X	X	X
0700 200 092	1.0–1.2	4 m	Red	X	X	X	X	X
0700 025 812	1.0–1.2	5 m	Red	X	X	X	X	X
0700 025 813	1.2–1.6	3 m	Yellow			X	X	X
0700 025 814	1.2–1.6	4 m	Yellow			X	X	X
0700 025 815	1.2–1.6	5 m	Yellow			X	X	X

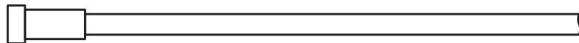
**PA Liner with bronze front end**

Ordering no.	Ø	Length	Notes	PSF 260	PSF 315	PSF 415	PSF 515	PSF 420w, PSF 430w, PSF 520w
0700 025 816	0.8–1.0	3 m	Anthracite	X	X	X	X	X
0700 025 817	0.8–1.0	4 m	Anthracite	X	X	X	X	X
0700 025 818	0.8–1.0	5 m	Anthracite	X	X	X	X	X
0700 025 819	1.2–1.6	3 m	Anthracite		X	X	X	X
0700 025 820	1.2–1.6	4 m	Anthracite		X	X	X	X
0700 025 821	1.2–1.6	5 m	Anthracite		X	X	X	X





A WORLD OF PRODUCTS AND SOLUTIONS.



For contact information visit esab.com

ESAB AB, Lindholmsallén 9, Box 8004, 402 77 Gothenburg, Sweden, Phone +46 (0) 31 50 90 00

<http://manuals.esab.com>

