



Lasting Connections

# PPE & ACCESSORIES CATALOGUE 2023/24



voestalpine Böhler Welding  
[www.voestalpine.com/welding](http://www.voestalpine.com/welding)

voestalpine

ONE STEP AHEAD.





As a passionate developer of innovative products we are the ideal partner and solution provider for safe welding. We put the welder's daily challenges and highest expectations into the center of our activities. This creates trust into our products and guarantees effective protection, outstanding quality and excellent comfort in accomplishing the welder's tasks.

# CONTENT

## Personal protective Equipment 5

HEAD TOPS AND WELDING RESPIRATORY SYSTEMS .....	6
HEAD TOPS .....	8
HEAD TOPS PREPARED FOR AIR .....	14
WELDING RESPIRATORY SYSTEMS .....	20
WELDING APPAREL .....	31
WELDING GLOVES .....	34
EYEWEAR .....	39

## ARC Welding Accessories 41

WELDING TOOLS .....	42
WELDING CHEMICALS .....	43
WELDING BLANKETS .....	44

## JOIN! voestalpine Böhler Welding 47







PERSONAL  
PROTECTIVE  
EQUIPMENT

# HEAD TOPS & WELDING RESPIRATORY SYSTEMS

## HEAD TOPS

---



Guardian<sup>50</sup>



Guardian<sup>62</sup>



Guardian<sup>62</sup> - La Catrina



Guardian<sup>62F</sup>

## HEAD TOPS PREPARED FOR AIR

---



Guardian<sup>50M</sup> Air



Guardian<sup>50FM</sup> Air



Guardian<sup>62</sup> Air



Guardian<sup>62F</sup> Air

## RESPIRATORY SYSTEMS

---



Guardian Air



Evolution Air





Evolution Vision<sup>65F</sup>



Evolution Vision<sup>65FM</sup>



Big Vision



Evolution Vision<sup>65F</sup> Air



Evolution Vision<sup>65FM</sup> Air



Big Vision Air



Supplied Air









# GUARDIAN - HELMET FAMILY

Guardian helmets are designed for a wide range of welding and grinding applications. In the focus of our product development is the welders' expectation for high-quality, comfortable and durable products. This means light weight products down to 480 grams with a robust headgear covered by soft sweatbands and high ADF clarity with true colour technology.

Guardian<sup>62</sup> - designed for highest expectations:



## Product features:

 <p>4 / 5-9 9-13 Variable Shade</p>	 <p>62 x 98mm Large Viewing Area</p>	 <p>4 x Four Sensors</p>	 <p>1\1\1\2 opt. Class CE Classification</p>
 <p>Comfort Headgear</p>	 <p>Grinding Mode</p>	 <p>True Blue Colour</p>	 <p>480g Light Weight</p>



# WELDING HELMETS

- » High Impact Nylon Shell
- » Comfort-Headgear with longitudinal and angular adjustments, smooth ratchet
- » Certified for CE, UKCA, ANSI, CSA

## Guardian<sup>50</sup>

- » Guardian<sup>50</sup> ADF:
  - » Shade level 4, 9-13
  - » External shade adjustment knob
  - » Grind mode button
  - » Viewing area: 50 x 100 mm - True Blue Colour
  - » EN 379 classification 1/1/1/2 - 4 arc sensors

For a wide range of welding and grinding applications.

32371



## Guardian<sup>62</sup>

- » Guardian<sup>62</sup> ADF:
  - » Shade 4, 5-9 / 9-13 - Suitable for TIG welding applications (> 5 Amps.)
  - » Grind mode button
  - » Viewing area: 62 x 98 mm - True Blue Colour with Best-In-Class-Clarity
  - » EN 379 classification 1/1/1/2 - 4 arc sensors
- » Lightweight at 480 gram

The expert's choice. Ideal for MAG and TIG welding applications.

32373



## Guardian<sup>62</sup> La Catrina - Special Edition

- » Guardian<sup>62</sup> ADF - Specifications as Guardian<sup>62</sup>
  - » Shade 4, 5-9 / 9-13 - Suitable for TIG welding applications (> 5 Amps.)
  - » Grind mode button
  - » Viewing area: 62 x 98 mm - True Blue Colour with Best-In-Class-Clarity
  - » EN 379 classification 1/1/1/2 - 4 arc sensors
- » Lightweight at 480 gram

72394



## Guardian<sup>62F</sup>

- » Guardian<sup>62</sup> ADF - Specifications as Guardian<sup>62</sup>
- » Flip-up welding helmet combining the technical advantages of the Guardian<sup>62</sup> with view a clear visor

The perfect solution for welding and grinding applications.

32374



## Guardian<sup>62</sup> - Limited Edition

Check our website for upcoming special editions

[www.voestalpine.com/welding](http://www.voestalpine.com/welding)





## EVOLUTION VISION - HELMET FAMILY

Evolution Vision<sup>65F</sup> & Evolution Vision<sup>65FM</sup> are the first products of this new family. These are Auto-Darkening Welding Helmets with a flip-up ultra high definition ADF combining a welding helmet with a wide view grinding screen.

### Product features:

	<p>Variable Shade</p>		<p>Large Viewing Area</p>		<p>Large Grinding Visor</p>		<p>Ultra high definition (UHD) Display - CE Classification</p>
	<p>5-strap high Comfort Headgear</p>		<p>Quick release ADF Cartridge</p>		<p>True Colour</p>		<p>Auto Shade Mode</p>



## Auto-darkening welding filter - Evolution Vision<sup>65F/65FM</sup>



### Special features:



**Auto Shade Mode:** The Evolution Vision<sup>65FM</sup> ADF adjusts the shade level by detecting the amperage of the striking arc on its own. Nevertheless, the protection level can be adjusted by +/- 2 levels to suit your personal needs. The switch back to a manual shade adjustment is possible at any time.



**Ultra high definition (UHD) Display:** Besides true colour recognition, the clarity of the display is even more important for the eyes. The clearer the display, the less strain is put on the eyes and the less fatigue will appear throughout the day.

## Evolution Vision - multi-adjust headgear

5-head straps for optimized balance and wearing comfort



Adjustable straps for an perfect fit

Quick and easy depth and tilt adjustment with press buttons and lever

Lowered neck strap with an easy adjust and tiltable ratchet

# WELDING HELMETS

- » High-impact and heat-resistant nylon shell
- » Multi-adjust headgear with sweatband
- » Certified to CE, UKCA, ANSI, CSA, AS/NZS



## Evolution Vision<sup>65F</sup> - glossy blue

- » Evolution Vision<sup>65F</sup> ADF:
  - » Shade 3, 4-8/9-14
  - » Viewing area: 65 x 96 mm - True Colour
  - » UHD display - EN 379 classification 1/1/1/1
  - » Digital display and easy ADF setting
- » Clear grinding lens with a wide viewing area (180 x 90 mm)
- » incl. 1 pce. spare battery, 3 pcs. front cover lenses and 1 pce. head top pouch

87127



## Evolution Vision<sup>65FM</sup> - matt blue

- » Evolution Vision<sup>65FM</sup> ADF:
  - » Shade 3, 4-8/9-14
  - » **Auto Shade Mode** (+/- 2 shade level adjustment)
  - » Viewing area: 65 x 96 mm - True Colour
  - » UHD display - EN 379 classification 1/1/1/1
  - » Digital display and easy ADF setting
- » Clear grinding lens with a wide viewing area (180 x 90 mm)
- » incl. 1 pce. spare battery, 3 pcs. front cover lenses and 1 pce. head top pouch

87130





## BIG VISION - GRINDING VISOR

Our Big Vision grinding visor offers full protection for eyes and face from particles and dust, and an unrestricted view of your workplace.

### Big Vision - matt black

- » High-impact and heat-resistant nylon shell
- » Comfort-headgear with sweatband same as for our Guardian helmets
- » Clear lens with a wide viewing area of 180 x 160 mm for an unrestricted field of vision during work
- » Certified to CE, UKCA, ANSI, CSA
- » Light weight - 370 g

73280



# HEAD TOPS PREPARED FOR AIR

All Böhler Welding head tops prepared for a air are fitted with face-seal and uniform air duct connectors allowing the interchange between different fresh air systems. All head tops are certified to the highest possible standards with P R SL filters.

## Air distribution inside a Guardian<sup>62</sup> Air:



### Guardian<sup>50M</sup> Air - matt blue

- » Guardian<sup>50</sup> ADF:
- » Shade 4, 9-13
- » External shade adjustment knob
- » Grind mode button
- » Viewing area: 50 x 100 mm - True Blue Colour
- » EN 379 classification 1/1/1/2

86669



### Guardian<sup>50FM</sup> Air - matt blue

- » Guardian<sup>50FM</sup> ADF:
- » **Shade 4, 5-9 / 9-13**
- » Internal grind mode
- » Viewing area: 50 x 100 mm - True Colour
- » EN 379 classification 1/1/1/2

86682



### Guardian<sup>62</sup> Air - glossy blue/metallic silver

- » Guardian<sup>62</sup> ADF:
  - » Shade 4, 5-9 / 9-13
  - » Grind mode button
  - » Viewing area: 62 x 98 mm - True Blue Colour
  - » EN 379 classification 1/1/1/2

57007



### Guardian<sup>62F</sup> Air - glossy blue

- » Guardian<sup>62</sup> ADF:
  - » Shade 4, 5-9 / 9-13
  - » Grind mode button
  - » Viewing area: 62 x 98 mm - True Blue Colour
  - » EN 379 classification 1/1/1/2

57029



### Evolution Vision<sup>65F</sup> Air - glossy blue

- » Evolution Vision<sup>65F</sup> ADF:
  - » Shade 3, 4-8 / 9-14
  - » Viewing area: 65 x 96 mm - True Colour
  - » UHD display - EN 379 classification 1/1/1/1
  - » Digital display and easy ADF setting
  - » Clear grinding lens with a wide viewing area (180 x 90 mm)
  - » incl. 1 pce. spare battery, 3 pcs. front cover lenses and 1 pce. head top pouch

87438\*

\* available in Q3/2023



### Evolution Vision<sup>65FM</sup> Air - matt blue

- » Evolution Vision<sup>65FM</sup> ADF:
  - » Shade 3, 4-8 / 9-14 + **Auto Shade Mode** (+/- 2 shade level adjustment)
  - » Viewing area: 65 x 96 mm - True Colour
  - » UHD display - EN 379 classification 1/1/1/1
  - » Digital display and easy ADF setting
  - » Clear grinding lens with a wide viewing area (180 x 90 mm)
  - » incl. 1 pce. spare battery, 3 pcs. front cover lenses and 1 pce. head top pouch

87440\*

\* available in Q3/2023



### Big Vision Air - glossy blue

- » High-impact and heat-resistant nylon shell
- » Comfort-headgear with sweatband same as for our Guardian helmets
- » Clear lens with a wide viewing area of 180 x 160 mm for an unrestricted field of vision during work

73314



# SPARE PARTS - HEAD TOPS

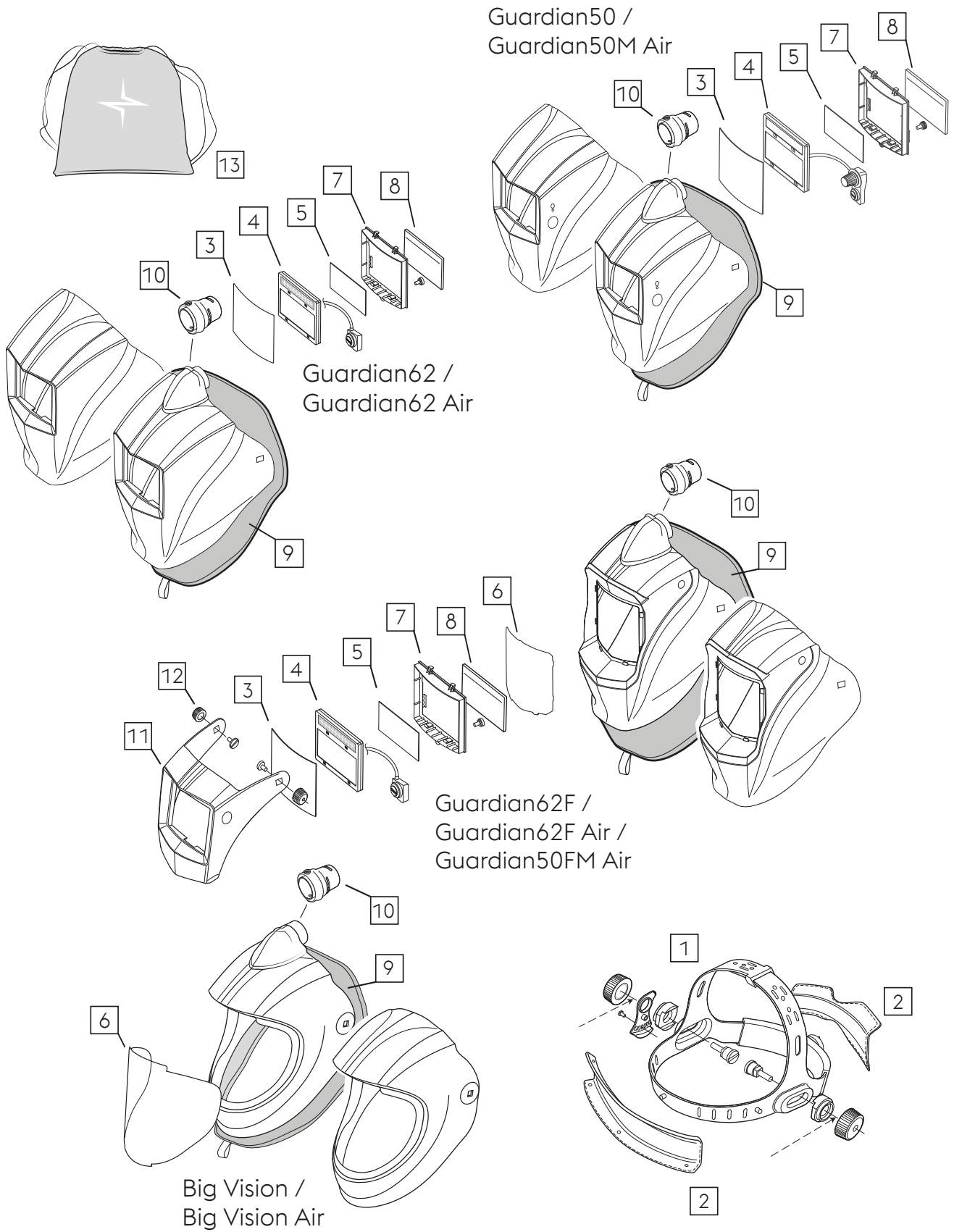

Product Name		Guardian 50	Guardian 62	Guardian 62F	Big Vision	Guardian 50M Air	Guardian 50FM Air	Guardian 62 Air	Guardian 62F Air	Big Vision Air	
1	Headgear Guardian	•	•	•	•	•	•	•	•	•	32406
2	Sweatband (Front and rear)	•	•	•	•	•	•	•	•	•	32416
3	Front cover lens (10 pieces)	•	•	•		•	•	•	•		32423
	Front cover lens HD (5 pieces)	•	•	•		•	•	•	•		87151
4	ADF Guardian <sup>62</sup> **		•	•				•	•		63635
	ADF Guardian <sup>50</sup> **	•				•					86693
	ADF Guardian <sup>50FM</sup> **						•				86697
5	Inner lens Guardian <sup>50</sup> (5 pieces)	•				•					32425
	Inner lens Guardian <sup>50FM</sup> (5 pieces)						•				86691
	Inner lens Guardian <sup>62, 62F</sup> (5 pieces)		•	•				•	•		32433
6	Grinding visor Guardian <sup>62F</sup> (2 pieces)			•			•		•		32437
	Grinding visor Big Vision (2 pieces)				•					•	73287
7	ADF retainer and screw Guardian <sup>62, 62F, 50FM</sup>		•	•			•	•	•		32442
	ADF retainer and screw Guardian <sup>50, 50M</sup>	•				•					32443
8	Dioptre 1.0	•	•	•				•	•		32444
	Dioptre 1.5	•	•	•				•	•		32445
	Dioptre 2.0	•	•	•				•	•		32452
	Dioptre 2.5	•	•	•				•	•		32456
9	Face seal					•	•	•	•	•	57182
10	Air duct (on head top)					•	•	•	•	•	87143
11	Flip-Element incl. screws and knobs (matt blue)						•				87147
	Flip-Element incl. screws and knobs (glossy blue)			•					•		87148
12	Screws and knobs for flip-element			•			•		•		87726***
*	Battery ADF CR2450	•	•	•		•	•	•	•		32517
*	Plunger (2 pcs.) for Inner lens exchange	•	•	•		•	•	•	•		87601
13	Böhler Head Top Pouch (black)	•	•	•	•	•	•	•	•	•	87139

\*not pictured in the graphic above | \*\* excl. battery CR2450 | \*\*\* available in Q3/2023



## Spare Parts - Evolution Vision

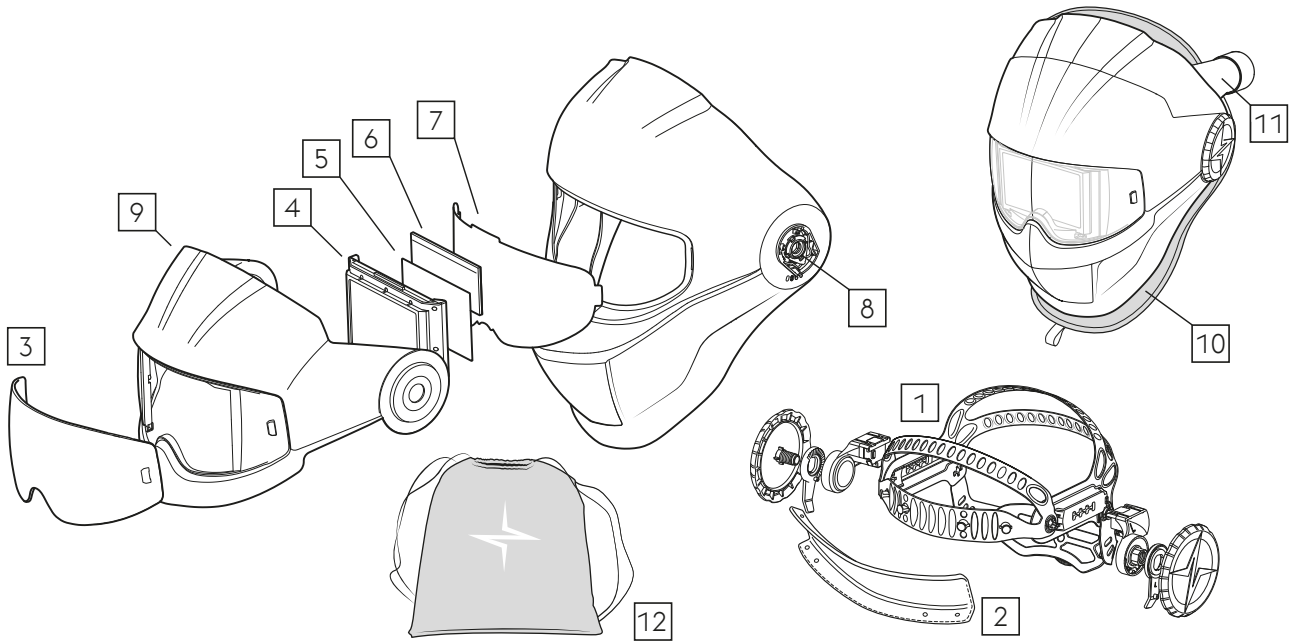

Product Name		Evolution Vision 65F	Evolution Vision 65FM	Evolution Vision 65F Air	Evolution Vision 65FM Air	
1	Headgear Evolution Vision	•	•	•	•	87134
2	Sweatband Evolution Vision	•	•	•	•	87136
3	Front Cover Lens (5 pieces)	•	•	•	•	87132
4	ADF Evolution Vision 65F **	•	•	•	•	87137
	ADF Evolution Vision 65FM (auto-shade) **	•	•	•	•	87135
5	Inner Cover Lens (2 pieces)	•	•	•	•	87131
6	Dioptré 1.0	•	•	•	•	32444
	Dioptré 1.5	•	•	•	•	32445
	Dioptré 2.0	•	•	•	•	32452
	Dioptré 2.5	•	•	•	•	32456
7	Grinding Visor (2 pieces)	•	•	•	•	87133
8	Spring kit Evolution Vision (2 springs + 2 arms)	•	•	•	•	87138
9	Flip-Element (matt blue)		•		•	87600
	Flip-Element (glossy blue)	•		•		87603
10	Face seal Evolution Vision			•	•	87596
11	Air duct Evolution Vision			•	•	87441
*	Battery ADF CR2450	•	•	•	•	32517
*	Plunger (2 pcs.) for Inner lens exchange	•	•	•	•	87601
12	Böhler Head Top Pouch (black)	•	•	•	•	87139

\*not pictured in the graphic | \*\* excl. battery CR2450

## Helmet & Kit Bags

### Böhler Head Top Pouch (black)

- » Stylish pouch to protect and easily transport your head top
- » With pockets to fit your personal belongings and spare parts
- » Colour: black

57029



### Böhler bag

- » Comfortable Bag to store your Personal Protective Equipment
- » Fitted with a length-adjustable shoulder harness for easy transport
- » Three side pockets on the inside offer order for your personal belongings and spare parts
- » Colour: black

86702



### Böhler bag

- » Comfortable Bag to store your Personal Protective Equipment
- » Fitted with a length-adjustable shoulder harness for an easy transport
- » Three side pockets on the inside offer order for your personal belongings and spare parts
- » Colour: blue

57186



### Evolution Bag

- » Stylish bag to store your Personal Protective Equipment
- » Fitted with a length-adjustable shoulder harness for an easy transport
- » Outer and inner pockets for an even better storage of your personal belongings and spare parts
- » Colour: blue

87597\*

\* available in Q3/2023



# WELDING RESPIRATORY SYSTEMS

Our Evolution Air and Guardian Air systems are Powered Air-Purifying Respiratory systems (PAPR-Systems) that provide the welder with the best protection against particles and fumes related to welding and grinding applications.





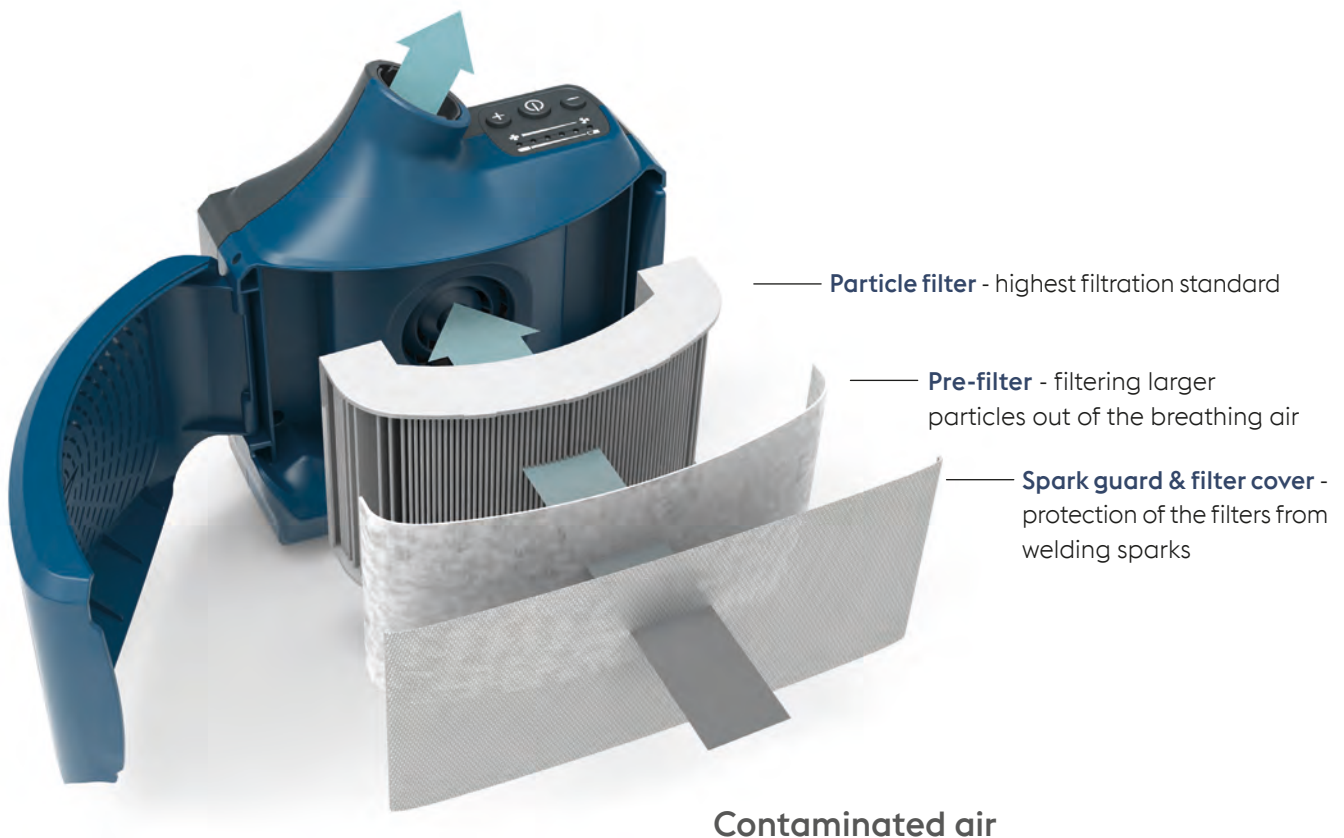

Both systems are tested and certified according to EN 12941 and protect your lungs with filtered breathing air that is 99,8 % particle-free by meeting the highest level of certification which is known as TH3. Furthermore, our well known Böhler Air system has the facility to add gas filters with an active carbon medium. These gas filters go beyond protection for not just welding fume but gases. With this we emphasize once again how important the issue of personal protection is for us.

## GUARDIAN AIR

99,8 % particle free air



### Product features

- |   |  |   |   |  |
|---|--|---|---|--|
|  <p><b>TH 3</b><br/>certificated</p> | <p>99.8 % particle free<br/>-breathing air</p>             |  <p>Fast &amp; easy filter change</p>                    |  <p>180-220 l</p>  | <p>For perfect airflow<br/>setting in 6 levels</p> |
|  <p>8 hours</p>                      | <p>Operating time up to 8 hours<br/>(Standard Battery)</p> |  <p>Visual, audible and<br/>vibrating warning system</p> |  <p>Shoulder harness for high<br/>wearing comfort (optional)</p> |  |





#### Guardian Air Kit (Complete Blower Unit w/o helmet)

##### Specifications:

- » Particle filter (P R SL)
- » EN 12941 highest protection class **P R SL TH3**
- » Operating time: Up to 8 h for the standard battery 5.200 mAh
- » Charging time: 4 - 6 hours - Universal Charger
- » Flow rate 180 - 220 l/min - adjustable at 6 levels
- » Visual, audible and vibrating warning for insufficient airflow and/or low battery charge
- » Weight: 870 g (including battery, assembled filter)
- » Certified to CE, UKCA

##### Ready to use kit:

- » including motor unit with assembled particle filter, pre-filter and spark guard, flexible air hose, standard battery, universal charger, comfort belt, and airflow tester

86692

# EVOLUTION AIR

99,8 % particle free air

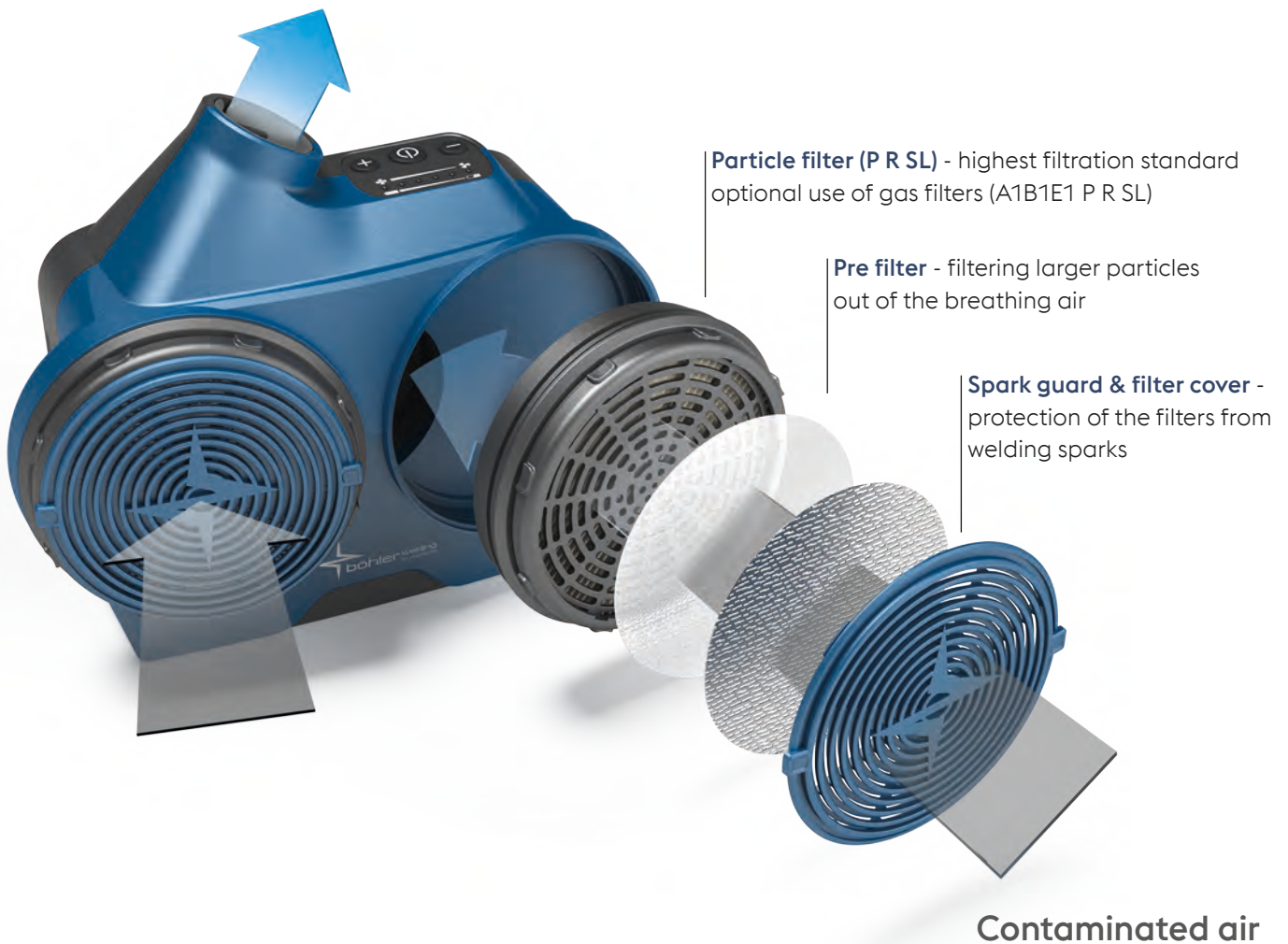

## Product features

**TH 3**  
P R SL  
certificated  
99.8 % particle free  
breathing air

**ABE**  
P R SL  
certificated  
Certified for gas filter  
(A1B1E1 P R SL)

  
180-240 l  
For perfect airflow  
setting in 6 levels

14 hours  
**HD**  
Operation time up to  
14 hours (heavy-duty battery)

  
Visual, audible and  
vibrating warning system

  
Shoulder harness for high  
wearing comfort





### Evolution Air (Complete Blower Unit w/o helmet)

#### Specifications:

- » Particle filters (P R SL) or **optional use of gas filters (A1B1E1 P R SL)**
- » EN 12941 highest protection class P R SL TH3
- » Operating time: Up to 14 h for the heavy-duty battery 7.800 mAh
- » Charging time: 8 - 9 hours - Universal charger
- » Flow rate 180 - 240 l/min - adjustable at 6 levels
- » Visual, audible and vibrating warning for insufficient airflow and/or low battery charge
- » Weight: 1.120 g (including battery, assembled filters)
- » Certified to CE, UKCA

#### Ready to use kit:

- » including motor unit with assembled particle filters, pre-filters, spark guards and filter covers, flexible air hose, heavy-duty battery, universal charger, comfort belt, shoulder harness and air-flow tester

77008





## SUPPLIED AIR

Our Supplied Air is a respiratory protective device that must be used in conjunction with a continuous flow compressed airline apparatus. The belt-mounted unit delivers air from a compressed air source (compressor and/or airline system), reduces the air pressure to a breathable level and supplies it via an air hose into the head top.

Supplied Air is suitable for extensive maintenance or cleaning jobs taking place within a defined area.

### Supplied Air w/o helmet

#### Specifications:

- » EN 14594 highest protection class 4A - max. inward leakage 0.05 %
- » Flow rate 180 - 220 l/min - adjustable at 7 levels
- » Supply tube connector - Coupling type: CEJN 320
- » Audible alarm for insufficient flow rate (below 170 L/min)
- » Minimal maintenance with nuisance filter and sealing ring
- » Certification acc. to EN 12021 for the source of compressed air required
- » Weight: 475 g (without belt)
- » Certified to CE, UKCA

#### Ready to use kit:

- » including nuisance filter, sealing ring, flexible air hose, small comfort belt and air flow tester

57038

## Compatible head tops:



**Guardian<sup>50M</sup> Air**  
Art.-No.: 86669



**Guardian<sup>50FM</sup> Air**  
Art.-No.: 86682



**Guardian<sup>62</sup> Air**  
Art.-No.: 57007



**Guardian<sup>62F</sup> Air**  
Art.-No.: 57029



**Supplied Air**



**Evolution Vision<sup>65F</sup> Air**  
Art.-No.: 87438\*



**Evolution Vision<sup>65FM</sup> Air**  
Art.-No.: 87440\*



**Big Vision Air**  
Art.-No.: 73314

\* available in Q3/2023

## Comparison of PAPR Systems and Supplied Air:

	<b>PAPR - Evolution Air</b>	<b>Supplied Air</b>
<b>Work environment</b>	Mobile device - not bound to a specific place	External compressed air source required - limited work space, stationary work, assembly-line work
<b>Working time*</b>	Max. 14 hours - limited to battery capacity	Max. 90 hours - limited to required maintenance
<b>Breathing air supply</b>	Surrounding air is filtered and supplied	External filtered air is delivered via a compressed air tube, de-pressurized and supplied
<b>Weight</b>	1.120 g including heavy-duty battery	475 g - compact design and less weight
<b>Required Maintenance</b>	Exchange of main filters and pre-filters + charging of the battery on a regular basis required	Exchange of nuisance filter

\* in an ideal and clean work environment and/or

# READY TO USE KITS WELDING RESPIRATORY SYSTEMS WITH HEAD TOPS



## Evolution Vision<sup>65F</sup> Air Kit

- » Evolution Air with Evolution Vision<sup>65F</sup> Air in a stylish Evolution bag (blue)
- » Evolution Vision<sup>65F</sup> ADF
  - » Shade 3, 4-8 / 9-14
  - » Viewing area: 65 x 96 mm - True Colour Technology
  - » UHD display - EN 379 classification 1/1/1/1
- » Heavy-duty battery (7.800 mAh) with quick charge-function
- » Incl. 2 pcs. front cover lenses, 2 pcs. grinding visor, 20 pcs. pre-filter and 1 pce. spare ADF battery

87436\*

\* available in Q3/2023



## Evolution Vision<sup>65FM</sup> Air Kit

- » Evolution Air with Evolution Vision<sup>65FM</sup> Air in a stylish Evolution bag (blue)
- » Evolution Vision<sup>65FM</sup> ADF
  - » Shade 3, 4-8 / 9-14 + **Auto shade mode** (+/- 2 shade level adjustment)
  - » Viewing area: 65 x 96 mm - True Colour Technology
  - » UHD display - EN 379 classification 1/1/1/1
- » Heavy-duty battery (7.800 mAh) with quick charge-function
- » Incl. 2 pcs. front cover lenses, 2 pcs. grinding visor, 20 pcs. pre-filter and 1 pce. spare ADF battery

87437\*

\* available in Q3/2023



## Guardian<sup>62</sup> Air Kit

- » Evolution Air with Guardian<sup>62</sup> Air in a comfortable Böhler bag (blue)
- » Guardian<sup>62</sup> ADF:
  - » Shade 4, 5-9 / 9-13
  - » External grind mode button
  - » Viewing area: 62 x 98 mm - True Colour Technology
  - » EN 379 classification 1/1/1/2

77004



## Guardian<sup>62F</sup> Air Kit

- » Evolution Air with Guardian<sup>62F</sup> Air in a comfortable Böhler bag (blue)
- » Guardian<sup>62F</sup> ADF:
  - » Shade 4, 5-9 / 9-13
  - » External grind mode button
  - » Viewing area: 62 x 98 mm - True Colour Technology
  - » EN 379 classification 1/1/1/2

77006



### Guardian<sup>50M</sup> Air Kit

- » Guardian Air with Guardian<sup>50M</sup> Air in a comfortable Böhler bag (black)
- » Guardian<sup>50</sup> ADF:
  - » Shade 4, 9-13
  - » External shade adjustment knob and grind mode button
  - » Viewing area: 50 x 100 mm - True Blue Colour Technology
  - » EN 379 classification 1/1/1/2

86615



### Guardian<sup>50FM</sup> Air Kit

- » Guardian Air with Guardian<sup>50FM</sup> Air in a comfortable Böhler bag (black)
- » Guardian<sup>50FM</sup> ADF:
  - » **Shade 4, 5-9 / 9-13**
  - » Internal grind mode
  - » Viewing area: 50 x 100 mm - True Colour Technology
  - » EN 379 classification 1/1/1/2

86644







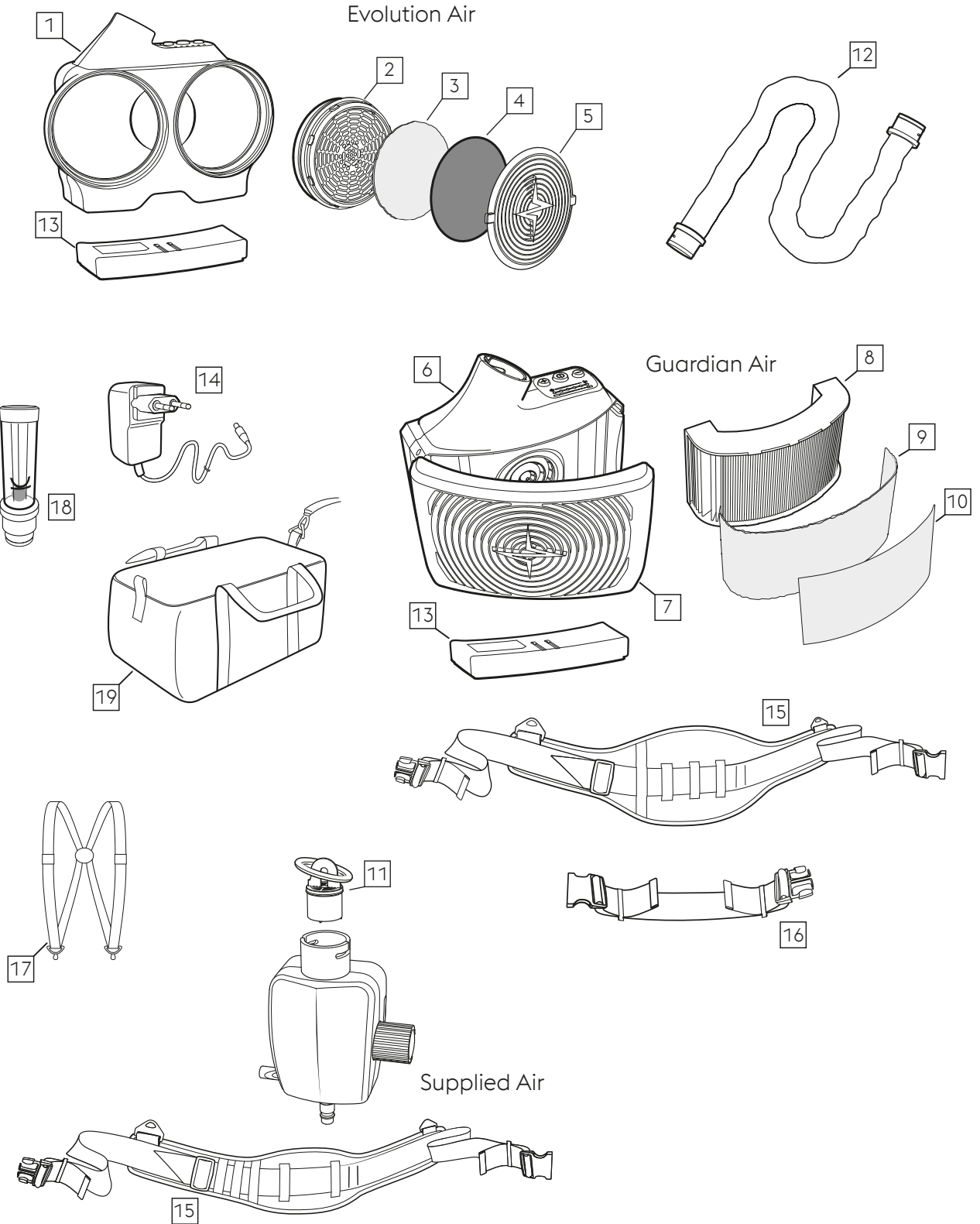



# SPARE PARTS FOR RESPIRATORY PROTECTIVE DEVICES



### Evolution Air - Spare Parts

1		Evolution Air - Motor unit	
			77011
2		Particle filter P R SL	
		(4 pieces)	57106
		(16 pieces)	57120
2		Gas filter A1B1E1 P R SL	
		(2 pieces)	57127
3		Pre-filter	
		Standard (20 pieces)	57097
		Standard (40 pieces)	57099
		Odour-pre-filter (6 pieces)	75094
4		Spark guard	
		(2 pieces)	57089
5		Filter cover	
		(2 pieces)	57082









### Guardian Air - Spare Parts

6		Guardian Air Motor Unit incl. cover	
			86668
7		Filter cover	
			86657
8		Particle filter P R SL	
		(4 pieces)	86645
9		Pre-filter	
		(10 pieces)	86655
10		Spark guard	
			86704

### Supplied Air - Spares

11		Nuisance filter + Sealing ring	
			76958

### General Spares

12		Air hose (incl. air hose cover)	
		Standard (100 cm)	64915
		Flexible (90-125 cm)	57065
13		Battery	
		Heavy-duty (7.800 mAh)	57075
		HD quick-charge (7.800 mAh)	87598*
		Standard (5.200 mAh)	86660
14		Universal charger	
		Standard	57081
		Quick-charger (for HD quick-charge only)	87599*
15		Comfort belt	
		Standard	57144
		Leather	75685
		Small (for Supplied Air)	76992
16		Comfort belt	
		Belt extension (+265 mm)	64255
17		Shoulder harness	
			57146
18		Airflow tester	
			57184
19		Böhler bag	
		blue	57186
		black	86702
19		Evolution Bag	
		blue	87597*

\* available in Q3/2023





# WELDING APPAREL

Welding and grinding produces hot weld beads, bright arcs, flying sparks and grinding particles, which not only cause skin irritation but can also lead to serious injuries. Our protective clothing made of leather, combined with breathable and flame-retardant cotton, ensures perfect protection with a maximum wearing comfort and a feel-good effect. Our clothes are certified according to the highest possible ISO standard.



## Leather/FR Welding Jacket & Trousers

- » Blue Cow Split Leather for durability and thermal insulation
- » FR cotton for lighter wearing comfort, less perspiration
- » Push buttons for secure closing and safer for fast opening
- » Pockets for your tools and personal belongings
- » 100 % aramid fibre stitching for highest durability of the seams
- » Certified according to ISO 13688 and EN ISO 11611:2015 Class 2 - A1



EN ISO 11611:2015  
Class 2 - A1

## Size Chart:

Leather/FR Welding Jacket				
International size	M	L	XL	XXL
German size	50	54	56	60
UK size	40-42	44-46	48-50	52-54
Chest / hip circumference (cm)	120/118	130/128	140/138	150/148
Art. No.	<b>84776</b>	<b>84778</b>	<b>84786</b>	<b>84790</b>

Leather/FR Welding Trousers					
International size	S	M	L	XL	XXL
German size	46	50	52	54	56
UK size	32	34	36	38	40
Hip circumference / full length (cm)	104/109	109/110	114/111	119/112	124/113
Art. No.	<b>84798</b>	<b>84818</b>	<b>84832</b>	<b>84852</b>	<b>84868</b>



# WORK WEAR PROTECTION

Gaiters, sleeves and aprons are made of high-quality leather in combination with aramid fibre seams to protect the welder, e.g. when welding, grinding and cutting in difficult positions like sitting or lying, as well as when welding under more severe thermal conditions and with increased spattering.



EN ISO 11611:2015  
Class 2 - A1

## Leather Welding Apron

- » Additional protection from chest to mid-calf made of blue cow split leather. Offers highest protection against sparks and spatters through durable leather & seams. Adjustable straps at back and neck with buckles guarantee an easy fitting.
- » One size fits all.
- » 100% aramid fibre stitching
- » Certified acc. to ISO 13688 and EN ISO 11611:2015 Class 2 - A1

84759



EN ISO 11611:2015  
Class 2 - A1

## Leather Welding Sleeves (in pairs)

- » Additional protection made of blue cow split leather for heavy duty welding & grinding applications. Fits perfectly on every arm and offers highest durability of leather & seams.
- » Elasticated cuff and velcro fastening for an easy fitting.
- » One size fits all.
- » 100% aramid fibre stitching
- » Certified according to ISO 13688 and EN ISO 11611:2015 Class 2 - A1

84760



EN ISO 11611:2015  
Class 2 - A1

## Leather Welding Gaiters (in pairs)

- » Our gaiters, made of blue cow split leather, are designed to offer additional protection against sparks and spatters from shin to foot by using high quality material.
- » Fast and easy to fit by leather straps with velcro and elastic band underneath the shoe sole.
- » One size fits all.
- » 100% aramid fibre stitching
- » Certified acc. to ISO 13688 and EN ISO 11611:2015 Class 2 - A1

84750



IEC 61482-2:2020  
EN 61482-1-2:2014  
APC=1  
EN61482-1-1:2019  
EBT50 = 6.8cal/cm<sup>2</sup>  
ELIM = 5.6cal/cm<sup>2</sup>



EN ISO 11612:2015  
A1 A2 B1 C1



EN 1149-3:2004  
FN1149-5:2018

## Balaclava FR

- » Fire retardant fabric (60% Modacrylic; 38% Cotton; 2% Antistatic)
- » Full protection of head and neck
- » One size fits all.
- » Certified according to: IEC 61482, EN ISO 11612 and EN 1149,

76924



böhler welding

BOSCH  
Professional



# WELDING GLOVES

Contact with sharp, pointed, rough, and hot objects is one of the most common causes of workplace injuries. In addition, there is an increased electrical hazard when welding. With our welding gloves, we meet the highest demands for cutting, tearing, and perforation resistance as well as heat.



## HARMLESS TO HEALTH

Materials and products used in and for our Welding Gloves comply with the REACH regulation.

## COW & GOAT LEATHER

The right use of split and grain leather from cow and goat combined with perfect shape guarantees products of highest quality.

### Regulations:

#### PPE Regulation (EU) 2016/425 – Category II

Our gloves are marked with a pictogram showing the protection properties according to the standards. All category II gloves are tested, validated and type certified by a notified body.

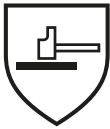

#### EN 388

Requirements for protection against mechanical risks, for maintenance work, plant cleaning, work with tools, metal structural work, handling of metal profiles, grinding and/or removal of burr, carpentry, handling of objects with sharp corners and of rough or abrasive objects.



#### EN 407

Requirements for protection against heat risks, for occasional contact with small flames and for contact with hot objects at temperatures not exceeding 100 °C.

#### EN 12477

Protective gloves for welders:

- » Type B - Gloves are recommended when high dexterity is required such as for TIG welding.
- » Type A - Gloves are recommended for other welding processes.



#### EN ISO 21420

General requirements for most protective gloves.

EN 388	min. - max. level
Abrasion resistance	1-4
Resistance to cutting	1-5
Resistance to tearing	1-4
Resistance to perforation	1-4
TDM: cut resistance	A-F

EN 407	min. - max. level
Fire behaviour	1-4
Contact heat	1-4
Convective heat	1-4
Radiating heat	1-4
Splattering with small quantities of molten metal	1-4



# WELDING GLOVES

With our new glove collection, we now offer our customers an even more robust portfolio. They are made of durable leather and aramid fibre stitches, providing temperature resistance and strength. Each type of glove has its own features, which allow us to build a full range of gloves from a classic to an ergonomic shape for every kind of welding process. Following the standard EN ISO 21420 our gloves are chrome-free (< 0,3 mg/l).

## MIG welding gloves - product features:

- » 1.3 mm cow split leather for durability and thermal insulation
- » Soft and pleasant inner gloves for great comfort
- » Aramid fibre stitching for highest durability of the seams

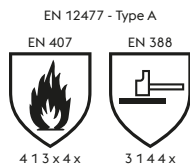

### MIG Classic

- » Comfortable MIG welding glove
- » Wing thumb construction for a natural thumb position
- » Fully welted seams (grey) for an increased durability
- » Certification: EN12477:2001+A1:2005 – Type A | EN407:2020 (4 1 3 x 4 x) | EN388:2016+A1:2018 (3 1 4 4 x)

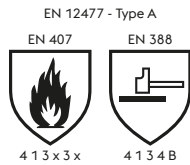

### MIG Heavy-Duty

- » Ideal for heavy-duty MIG and SMAW applications
- » Double layer on the palm for a highest heat protection and cut resistance
- » Wing thumb construction for a natural thumb position
- » Fleece lined heavy-duty jersey as inner glove
- » Fully welted seams (black) for an increased durability
- » Certification: EN12477:2001+A1:2005 – Type A | EN407:2020 (4 1 3 x 3 x) | EN388:2016+A1:2018 (4 1 3 4 B)

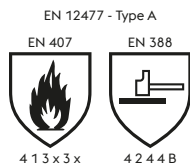

### MIG Curved Ultra

- » Ideal for heavy-duty MIG applications
- » Curved glove construction for an ergonomic shape and highest level of protection
- » Greater flexibility, less wear and better dexterity
- » Finger tips with welted seams (black) for increased durability of the fingers
- » Elasticated wrist for a perfect fit
- » Certification: EN12477:2001+A1:2005 – Type A | EN407:2020 (4 1 3 x 3) | EN388:2016+A1:2018 (4 2 4 4 B)



### TIG welding gloves - product features:

- » 1.1 mm goat leather (unlined) for best sensitivity and highest dexterity levels
- » Cow split leather cuff for heat protection around the wrist and lower arm
- » Aramid fibre stitching for highest durability of the seams

#### TIG Classic

- » The all-rounder for TIG applications
- » Basic glove design with reliable protection and dexterity
- » Wing thumb construction for a natural thumb position
- » Certification: EN12477:2001+A1:2005 – Type B | EN407:2020 (4 1 x x 4 x) | EN388:2016+A1:2018 (2 1 2 1 x)



#### TIG Soft

- » Ideal for precise TIG applications
- » Vein patch reinforcement for additional protection of the wrist as a sensitive area
- » Keystone thumb for a greater flexibility and better dexterity
- » Gunn-cut pattern (less seams) for high comfort around the fingers
- » Certification: EN12477:2001+A1:2005 – Type B | EN407:2020 (4 1 x x 4 x) | EN388:2016+A1:2018 (2 1 1 2 x)



#### TIG Curved Ultra

- » Ideal for any kind of TIG and light MIG applications
- » Curved glove construction for an ergonomic shape and highest level of protection
- » Greater flexibility and best dexterity
- » Elasticated wrist for a perfect fit
- » Certification: EN12477:2001+A1:2005 – Type A | EN407:2020 (4 1 2 x 3 x) | EN388:2016+A1:2018 (2 1 2 3 x)



### Size Chart:

Size	MIG Classic			MIG Heavy-Duty			MIG Curved Ultra		
	Art. No.	L (cm)	W (cm)	Art. No.	L (cm)	W (cm)	Art. No.	L (cm)	W (cm)
M/9	76883	20.5	13.5	76898	19.0	12.5	76873	20.5	12.5
L/10	76884	21.0	14.0	76909	20.0	13.0	76876	21.0	13.0
XL/11	-	-	-	-	-	-	83591	21.5	13.5

Size	TIG Classic			TIG Soft			TIG Curved Ultra		
	Art. No.	L (cm)	W (cm)	Art. No.	L (cm)	W (cm)	Art. No.	L (cm)	W (cm)
M/9	-	-	-	76791	20.5	11.5	76864	19.0	11.0
L/10	76813	21.0	12.0	76798	21.0	12.0	76872	19.5	11.5
XL/11	-	-	-	-	-	-	83607	20.0	12.0

L = Length

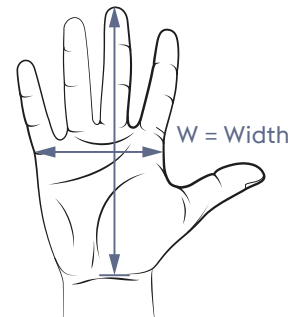

# ADDITIONAL HAND PROTECTION



## Alu handshield

- » Protect yourself even better by using our Alu Handshield
- » Aluminium layer for an increased heat protection resulting in longer working hours
- » Flexible straps allowing the handshield to be used with every welding glove type
- » Single size

76956



## Rigger Glove

- » Working glove with a perfect combination of comfort and protection
- » Cow split leather on heavily worn areas provides durability and safety
- » Breathable fabric on the back of the hand helps to reduce perspiration
- » Certification: EN388:2016+A1:2018 (4 1 4 4 x)
- » Single Size (10)

76918

# EYEWEAR

All of our Eyewear models are designed for the use in industrial environments with a variety of glasses certified according to EN 166.

## Benefits of Eyewear

- » High comfort and protective against UV-light
- » Safety spectacles conforming to EN 166
- » Microfibre pouch for storage and cleaning

### Eyewear Clear Pro

- » Large temples and soft pads for better elasticity and comfort
- » Hard coating on lenses with anti-fog properties
- » Upper shield above the lenses to increase protective coverage against falling particles
- » Product marking: CE VA EN 166 F - CE 2-1.2 VA 1F
- » Certified acc. to EN 170

52882



### Eyewear Classic

#### Eyewear Clear

- » For a general industrial use where flying particles may be a hazard.
- » Product marking: CE VA EN 166 F - CE 2-1.2 VA 1F
- » Certified acc. to EN 170

32457



#### Eyewear Amber

- » For the use in industrial area with low light conditions.
- » Product marking: CE VA EN 166 F - CE 2-1.2 VA 1F
- » Certified acc. to EN 170

32458



#### Eyewear Blue Mirror

- » Outdoor industrial work offering protection against bright sunlight.
- » Product marking: CE VA EN 166 F - CE 5-3.1 VA 1F
- » Certified acc. to EN 172

32464



#### Eyewear IR5

- » For welding and braze welding - flow rate of acetylene 70 - 200 l/h or oxygen cutting - flow rate of oxygen 900 - 2000 l/h
- » Product marking: CE VA EN 166 F - CE 5 VA 1F
- » Certified acc. to EN 169

32466







# ARC WELDING ACCESSORIES

# WELDING TOOLS



## Electrode holder "Snap"

Electrode holder in crocodile style with fully insulated handle and lever, spatter resistant tip insulator. Certified according to EN 60974-11 standard

<b>EH Snap 200</b> , 200 Amp (35 %), 5 mm opening	<b>61469</b>
<b>EH Snap 400</b> , 400 Amp (35 %), 6 mm opening	<b>61473</b>
<b>EH Snap 600</b> , 600 Amp (35 %), 8 mm opening	<b>61474</b>



## Electrode holder "Twist"

Screw-type electrode holder with fully insulated handle and spatter resistant tip insulator. Certified according to EN 60974-11 standard

<b>EH Twist 200</b> , 200 Amp (35 %), 4 mm opening	<b>61475</b>
<b>EH Twist 400</b> , 400 Amp (35 %), 6 mm opening	<b>61478</b>
<b>EH Twist 600</b> , 600 Amp (35 %), 8 mm opening	<b>61484</b>



## Earth clamp

Earth clamp in crocodile style for easy installation.  
Span of 50 mm (Clamp 300) and 65 mm (Clamp 400 and Clamp 600)  
Certified according to EN 60974-11 standard

<b>Clamp 300</b> with Brass Jaws, 300 Amp (35 %)	<b>61947</b>
<b>Clamp 400</b> with Brass Jaws, 400 Amp (35 %)	<b>61948</b>
<b>Clamp 600</b> with Brass Jaws, 600 Amp (35 %)	<b>61949</b>



## Chipping hammer

Both chipping hammer types are tempered and have hardened edges.  
Hammer head with one double beveled and one pointed edge.

<b>Chipping hammer</b> (small)	<b>61950</b>
<b>Chipping hammer</b> (curved point)	<b>61951</b>

# WELDING CHEMICALS

The most important result for a welder is the perfect weld and the best possible protection of base material and torches.

## Anti Spatter Spray

Our non-flammable Anti Spatter Spray is the perfect choice for the perfect weld! Unique formula and viscosity provides an outstanding adhesion on metallic surfaces, is non-harmful for the welder and biodegradable.

### Fields of application:

- » Oxy-fuel cutting
- » Plasma cutting
- » Spot welding
- » MIG-Brazing (CuSi3 / CuAl8)
- » Manual and robotic MIG/MAG torches
- » Hot-tip galvanized and electrogalvanized surfaces
- » Tools, welding jigs and working surfaces

Anti Spatter Spray	
» Water-based, <b>non flammable emulsion</b>	» Ideal viscosity
» Silicone-free	» 360° valve
» Anti-stick effect	» Stable emulsion
Anti Spatter Spray - ES - FR - EN - DE - IT - PT - NL - DA	63647
Anti Spatter Spray - FI - NO - SV - CZ - HU - PL - RO - BG	63660
Anti Spatter Spray - HR - RU - EL - ET - LT - LV - SK - SL	63661



## Ceramic Spray

Our Ceramic Spray is a high-temperature resistant and offers a long lasting protection for your welding equipment. The use of gas nozzles, contact tips and welding jigs becomes more efficient and economic. It is non-harmful for the welder and biodegradable.

### Fields of application:

- » Plasma cutting
- » Manual and robotic MIG/MAG torches
- » Tools and welding jigs

Ceramic Spray	
» Oil free solvent	» Ultra-fast drying ability
» Safe ingredients	» High ceramic content
Ceramic Spray - ES - FR - EN - DE - IT - PT - NL - DA	63663
Ceramic Spray - FI - NO - SV - CZ - HU - PL - RO - BG	63667





# WELDING BLANKETS

Welding Blankets are a piece of safety equipment designed to protect you, your equipment, our environment and other valuable items. However, they do not only provide protection from spatters, sparks, heat radiation, particle impacts and molten metals, they also insulate rays to establish a safe and clean work environment.

## General features:

- » No differentiation between sides - Front and back are equal in their properties
- » Anti-oxidation - No chemical reaction is triggered when sparks hit the welding blanket
- » All blankets are offering protection against spatters, sparks & slag

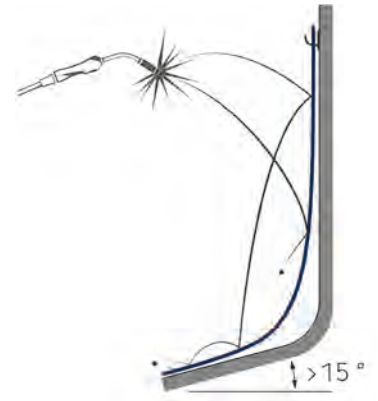

## Recommendation for use:

All blankets are to be used on an incline of at least 15 degrees.

Sparks hitting a blanket, which is positioned horizontally, will put extra stress on the material. In such a case a stronger and more heat resistant blanket should be used.

	WB Fibre 550	WB Fibre Plus 750	WB Silica 1100	WB Light 1250
				
Basic material	Fibreglass	Fibreglass	Uncoated Silica - 2% PU	O-PAN
Material structure	woven, plain	woven, plain	woven, 8HS Satin	felt
Coating/ treatment	-	Vermiculite	-	-
Mass	580 g/m <sup>2</sup>	875 g/m <sup>2</sup>	600 g/m <sup>2</sup>	420 g/m <sup>2</sup>
Thickness	0.75 mm	1.06 mm	0.70 mm	3.6 - 4.0 mm
Working temperature	550 °C	750 °C	1100 °C	250 °C
Melting point	750 °C	950 °C	1350 °C	(1250 °C - instant impact)
Colour	tan	black	tan	black



**Rolled welding blanket** - cut them according to their own needs

# WELDING BLANKET TYPES:

WB Fibre 550		
Technical specification	Features	Application
<ul style="list-style-type: none"> <li>» Uncoated fibreglass</li> <li>» Working temp.: 550 °C</li> <li>» Melting point: 750 °C</li> <li>» Weight: 580 g/m<sup>2</sup></li> </ul>	<ul style="list-style-type: none"> <li>» Temperature resistance</li> <li>» Eyelets on all four sides</li> </ul>	<ul style="list-style-type: none"> <li>» Light welding &amp; cutting</li> </ul>



WB Fibre Plus 750		
Technical specification	Features	Application
<ul style="list-style-type: none"> <li>» Vermiculite* coated fibreglass</li> <li>» Working temp.: 750 °C</li> <li>» Melting point: 950 °C</li> <li>» Weight: 875 g/m<sup>2</sup></li> </ul>	<ul style="list-style-type: none"> <li>» Higher abrasion resistance</li> <li>» Fireproof</li> <li>» Higher temperature resistance</li> <li>» Eyelets on all four sides</li> </ul>	<ul style="list-style-type: none"> <li>» Medium welding &amp; cutting processes</li> </ul>



WB Silica 1100		
Technical specification	Features	Application
<ul style="list-style-type: none"> <li>» Uncoated silica with 2% PU</li> <li>» Working temp.: 1100 °C</li> <li>» Melting point: 1350 °C</li> <li>» Weight: 600 g/m<sup>2</sup></li> </ul>	<ul style="list-style-type: none"> <li>» Acid resistance</li> <li>» Eyelets on all four sides</li> </ul>	<ul style="list-style-type: none"> <li>» Heavy duty welding &amp; cutting processes</li> </ul>



WB Light 1250		
Technical specification	Features	Application
<ul style="list-style-type: none"> <li>» 100% O-Pan* non-woven</li> <li>» Working temp.: 250 °C</li> <li>» Weight: 420 g/m<sup>2</sup></li> </ul>	<ul style="list-style-type: none"> <li>» Excellent thermal insulation</li> <li>» Impact protection against particles</li> <li>» <b>Fibreglass free</b> – smooth touch, no scratching</li> <li>» Light and portable</li> <li>» Can be easily cut</li> </ul>	<ul style="list-style-type: none"> <li>» Sand blasting &amp; heat treatment</li> <li>» Light welding &amp; cutting processes</li> <li>» Complicated &amp; narrow applications</li> <li>» Ideal for sensitive surfaces</li> <li>» Instant impact up to 1250°C*</li> </ul>

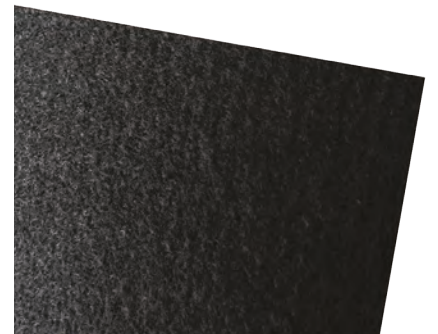

\* NOT TO BE USED AS EMERGENCY BLANKET!

## Product portfolio:

WB Fibre 550		WB Fibre Plus 750		WB Silica 1100		WB Light 1250	
Sizes	Art. No.	Sizes	Art. No.	Sizes	Art. No.	Sizes	Art. No.
1x1 m	72497	1x1 m	72655	0.92x1 m	72690	1x1 m	72730
1x2 m	72622	1x2 m	72662	0.92x2 m	72693	1x2 m	72752
2x2 m	72635	2x2 m	72677	1.80x2 m	72694	2x2 m	72754
2x3 m	72642	2x3 m	72678	1.80x3 m	72712	2x3 m	72759
1x25 m*	72650	1x25 m*	72681	0.92x25 m*	72723	1x25 m*	72760

\* Rolled welding blankets are without eyelets and can be tailored to your own needs.





# JOIN! voestalpine Böhler Welding

We are a leader in the welding industry with over 100 years of experience, more than 50 subsidiaries and more than 4,000 distribution partners around the world. Our extensive product portfolio and welding expertise combined with our global presence guarantees we are close when you need us. Having a profound understanding of your needs enables us to solve your demanding challenges with Full Welding Solutions - perfectly synchronized and as unique as your company.



**Lasting Connections** – Perfect alignment of welding machines, consumables and technologies combined with our renowned application and process know-how provide the best solution for your requirements: A true and proven connection between people, products and technologies. The result is what we promise: Full Welding Solutions for Lasting Connections.



**Tailor-Made Protectivity™** – Proven under the toughest conditions: Our products protect metal surfaces from wear and corrosion. With over 70 years of experience and the broadest product portfolio in the industry, we are your preferred partner for Surface Protection solutions. We deliver what we promise: Surface Protection tailored to your needs.



**In-Depth Know-How** – As a manufacturer of soldering and brazing consumables, we offer proven solutions based on 60 years of industrial experience, tested processes and methods, made in Germany. This in-depth know-how makes us the internationally preferred partner to solve your soldering and brazing challenge through innovative solutions. The result is what we promise: Innovation based on in-depth know-how.

The Management System of voestalpine Böhler Welding Group GmbH, Peter-Mueller-Strasse 14-14a, 40469 Duesseldorf, Germany has been approved by Lloyd's Register Quality Assurance to: ISO 9001:2015, ISO 14001:2015, OHSAS 18001:2007, applicable to: Development, Manufacturing and Supply of Welding and Brazing Consumables. More information: [www.voestalpine.com/welding](http://www.voestalpine.com/welding)



