



# HIGH-QUALITY MIGATRONIC WELDING ACCESSORIES

**MIGATRONIC**  
WELDING VALUE



# CONTENTS

<b>Personal safety .....</b>	<b>Page 4</b>
• Clothing .....	Page 4
• Welding gloves .....	Page 5
• Welding helmets .....	Page 6
Non-optical welding helmets .....	Page 6
Goggles .....	Page 6
Optical welding helmets.....	Page 6
Welding helmets with fresh air system .....	Page 9
• Welding filters and magnification lenses.....	Page 11
• Shielding .....	Page 12
• Welding blankets and fire blankets .....	Page 14
<b>Tools .....</b>	<b>Page 15</b>
<b>Fume extraction.....</b>	<b>Page 16</b>
<b>Tungsten grinding .....</b>	<b>Page 18</b>
<b>Pressure regulators.....</b>	<b>Page 20</b>
<b>Parts for pressure regulators.....</b>	<b>Page 23</b>
<b>Starter kits, wearing parts boxes etc. ....</b>	<b>Page 25</b>
<b>Chemicals .....</b>	<b>Page 26</b>
<b>Original Migatronic spare parts .....</b>	<b>Page 27</b>
• Multi plugs.....	Page 27
• Dinse plugs .....	Page 27
• Earth clamps .....	Page 27
• Electrode holders .....	Page 27



*We reserve the right to make changes to specifications and to make corrections in the event of a misprint.*

# HAVE YOU CHOSEN THE RIGHT ACCESSORIES? ALWAYS LOOK FOR THE MIGATRONIC BRAND

We know from experience that welders and their employers attach great importance to safety and quality, also when it comes to welding accessories.

This catalogue provides you with an overview of our range of high-quality welding accessories, designed specifically for the welding trade.

All products have been tested and approved and comply with all relevant safety regulations and standards.

For manuals and safety data sheets, please refer to [migatronic.com](http://migatronic.com).

Migatronic accessories provide  
**WELDING VALUE**  
during the complete welding process!



**MIGATRONIC**  
WELDING VALUE



**Clothing**

Personal safety is all-important to prevent weld spatter and grinding sparks from affecting welders' skin and clothes. Equally important are perfect fit and comfort during welding. All of Migatron's personal safety products carry CE qualification and materials and designs are carefully selected. **Migatron dresses you in branded clothing from top to toe.**



**WELDING JACKET**  
Lightweight welding jacket in fire-resistant fabric. Designed specifically for the welding industry. Protects against grinding particles and welding spatter. Onesize.

Art. no.....81930043



**WELDING APRON**  
Welding apron in split leather with riveted nylon strap and click buckle. Protects against grinding particles and weld spatter. Length 900 mm, width 580 mm.

Art. no.....81930015



**SKIRT APRON**  
Skirt apron in split leather with riveted nylon strap and click buckle. Protects against grinding particles and weld spatter. Length 500 mm, width 580 mm.

Art. no.....81930018



**WELDING HOOD HEAD AND BACK OF HEAD**  
Welding hood in split leather for protection of head and back of the head during welding and grinding.

Art. no.....81910117



**WELDING HOOD**  
Welding hood in fire-resistant fabric for protection of head, neck and shoulders against weld spatter, grinding particles and radiation.

Art. no.....81930042



**WELDING SLEEVES**  
Lightweight set of sleeves in fire resistant fabric with elastic and buttons for shoulder fixing. Protects against grinding particles and weld spatter.

Art. no.....81930040



**LEGGINGS**  
Leggings in sets of two in split leather with Velcro fastening. Protect shoes against grinding particles and weld spatter.

Art. no.....81930036



**NECK PROTECTION FOR WELDING HELMETS**  
Neck protection designed specifically for Migatron welding helmet. Protects against weld spatter and radiation.

Art. no.....81930041

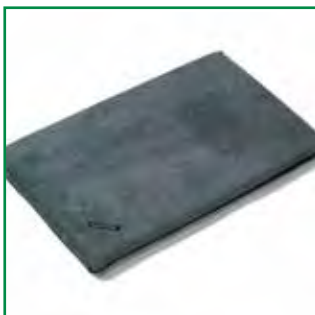

**WELDING MAT**  
Welding mat in leather and split leather. Length 520 mm, width 330 mm.

Art. no.....81930010

## Welding gloves

**Welders' hands are their most important tools!** Migatronik welding gloves ensure safe grip and perfect fit and reduce the risk of injury. Compliance with public health legislation concerning chrome-6 contents reduces the risk of allergic reactions.



**TIG WELDING GLOVES SIZE 10**  
Soft goatskin TIG welding gloves with cuffs made of cow-split. Sewn with Kevlar thread. Inside finger seams. Extra reinforced palm. Abrasion-resistant welding gloves with perfect fit for quality welding. Comply with health standards for chrome-6 content. Length 35 cm. Size 10.

Art. no.....81930070



**TIG WELDING GLOVES SIZE 11**  
Soft goatskin TIG welding gloves with cuffs made of cow-split. Sewn with Kevlar thread. Inside finger seams. Extra reinforced palm. Abrasion-resistant welding gloves with perfect fit for quality welding. Comply with health standards for chrome-6 content. Length 35 cm. Size 11.

Art. no.....81930071



**MIG WELDING GLOVES SIZE 10**  
Suede MIG welding gloves. Sewn with Kevlar thread. Extra reinforcement for improved grip and wearing properties. Fleece lining and elastic cuffs for perfect fit. Comply with health standards for chrome-6 content. Length 35 cm. Size 10.

Art. no.....81930074



**MIG WELDING GLOVES SIZE 11**  
Suede MIG welding gloves. Sewn with Kevlar thread. Extra reinforcement for improved grip and wearing properties. Fleece lining and elastic cuffs for perfect fit. Comply with health standards for chrome-6 content. Length 35 cm. Size 11.

Art. no.....81930075



**MIG HEAVY DUTY WELDING GLOVES SIZE 10**  
Suede MIG welding gloves sewn with Kevlar thread. Air-suspended fleece lining for increased heat resistance. Extra reinforcement for improved grip and wearing properties. Comply with health standards for chrome-6 content. Length 35 cm. Size 10.

Art. no.....81930072



**MIG HEAVY DUTY WELDING GLOVES SIZE 11**  
Suede MIG welding gloves sewn with Kevlar thread. Air-suspended fleece lining for increased heat resistance. Extra reinforcement for improved grip and wearing properties. Comply with health standards for chrome-6 content. Length 35 cm. Size 11.

Art. no.....81930073



## Welding helmets

**Migatronik does not compromise safety.** Our welding helmets provide maximum protection of the welder's eyes and face during welding to prevent workplace injuries. The helmets are designed for optimal welding comfort and optics. Our range meets all requirements, from traditional helmets to automatic types with fresh-air systems.

### Non-optical welding helmets and goggles



**HEADGEAR FOR WELDING HELMET**  
Headgear for polypropylene welding helmet

Art. no.....81910100



**MIGA FLIP UP WELDING HELMET**  
Welding helmet with Flip-up. Equipped with 60 x 110 mm passive welding filter. Supplied with shade 10 filter.

Art. no.....81910890



**WELDING SHIELD**  
Small, lightweight PVC hand-shield. Welding glass: 51 x 108 mm. Supplied with shade 10 filter.

Art. no.....81910144



**2 PCS SWEAT FRONTLETS**  
Sweat frontlet of imitation leather for fixing on headgear.

Art. no.....81910119



**GRINDING SHIELD**  
Grinding shield in clear plexi glass with pivot fittings in headgear.  
Art. no.....81910007

**VISOR FOR GRINDING SHIELD**  
Separate visor in plexi glass for grinding shield.  
Art. no.....81910008



**WELDING/GRINDING GOGGLES**  
Combined welding/grinding goggles with round carborock glass. Fixed grinding goggles and flip-up welding glasses. Glasses can be changed as required. For ø 50 mm glasses.  
Art. no.....81912005



**SAFETY GOGGLES**  
Sleek, sporty style goggle. Comfortable to wear owing to soft-touch temples and light-weight construction. Full range of vision.

Clear:  
Art. no.....81912017  
Amber:  
Art. no.....81912018  
Tinted mirror:  
Art. no.....81912019  
Shade 3:  
Art. no.....81912020  
Shade 5:  
Art. no.....81912021

## Optical welding helmets

### Migatronik Basic ADF

Art. no. 81910605

The Migatronik Basic ADF welding helmet, ideal for hobby, workshop use and light industrial welding, is equipped with ADF (auto darkening) filter and certified according to EN 379, EN 175, EN 166.



#### Technical data:

- Fully automatic filter (ADF)
- Externally variable shade DIN 9-13, open DIN 4
- Adjustable delay
- Field of view 100 x 41 mm
- Classification 1/1/1/2
- Adjustable sensitivity
- Solar with built-in battery
- Grinding function

Art. no.	Description
81910605	Migatronik Basic ADF
81911062	External shielding glass 90 X 110 mm
81911092	Internal shielding glass 47 X 105 mm

## Focus ADF

Art. no. 81910900

The Focus ADF welding helmet is ideal for hobby and workshop use and light industrial welding. The helmet features a fully automatic True Colour filter and is certified according to EN379, EN175 and EN166.

### Technical data:

- Fully-automatic filter (ADF)
- Externally variable shade 9-13
- Adjustable delay
- Field of view 97 x 47 mm
- Classification 1/1/1/2
- Adjustable sensitivity
- Solar
- Grinding function
- Magnification lenses size 51 x 108 mm can be fitted
- Can be fitted with hard hat

### Fields of application:

- MMA (electrode)
- MIG/MAG
- TIG (>10amps)
- Grinding

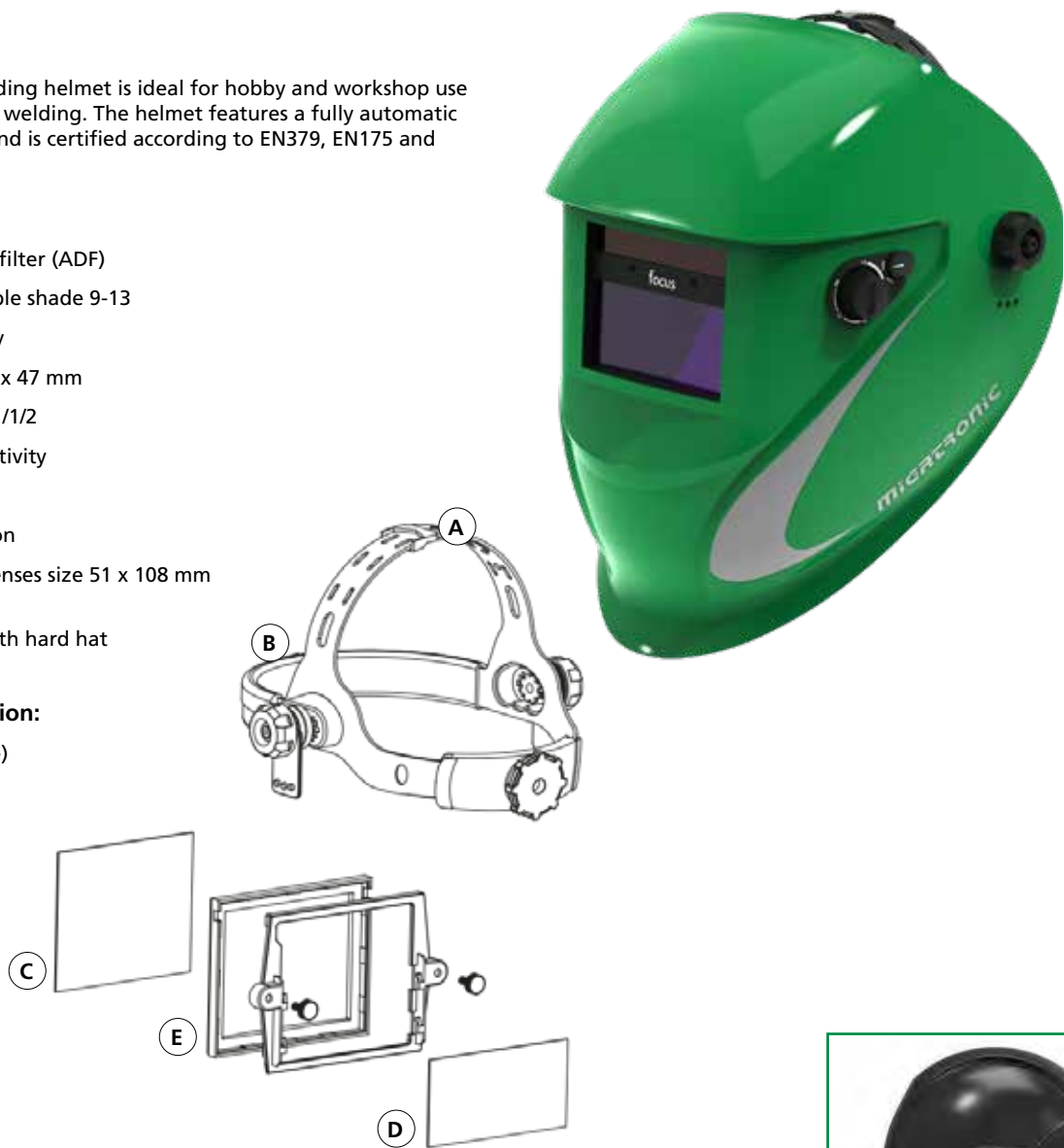

Pos.	Art. no.	Description
	81910900	Focus ADF welding helmet
A	81910905	Headgear
B	81910906	Sweat frontlet
C	81910801	External Shielding Glass 85.9x103.6 mm
D	81910802	Internal Shielding Glass 53.7x104.8 mm
E	81910904	ADF Mounting Frame Assembly
F	81910860	Hard hat
G	81910861	Adapter for mounting of hard hat

### Hard hat

For protection purposes, the Migatronix optical welding helmet Focus ADF and Focus MigADC<sup>plus</sup> can be equipped with a hard hat with brakes with built-in springs to keep it in place irrespective of welding position. The heavy-duty construction ensures long life of hard hat and adapter. If the welder stops welding, he can easily dismount the welding helmet, even with welding gloves on, and still be protected by the hard hat.

**MigADC<sup>plus</sup>**

The MigADC<sup>plus</sup> is ideal for welders in the manual and manufacturing industries where technical skills and attention to detail are a must. The MigADC<sup>plus</sup> provides optimal conditions for welders to produce high-quality welds.

New ADC\* technology in the optical filter compensates angular dependence significantly. The flashes of light that welders are exposed to may cause irritation of eyes but the MigADC<sup>plus</sup> provides full protection at +/-30° visual angle as well as full protection of welders' eye, neck and face movements.

\* ADC = Angular Dependence Compensation

**Classification: 1/1/1/1**

MigADC<sup>plus</sup> has achieved the top mark classification for optics, light diffusion, homogeneity and angular dependence.

**MigADC<sup>plus</sup> features:**

- Standard or Air model; the latter can be fitted with a fresh-air unit
- Clear field of view from all angles reduces eye fatigue and the need of adjusting functions
- Superior optics
- Aerodynamic design conducts away welding fumes
- External control knobs for adjustment of functions
- TIG mode (DIN 6-8)
- Can be fitted with frame for magnifying lenses
- Can be fitted with hard hat
- 3-year warranty

**Technical data:**

- Fully-automatic filter (ADF)
- Externally variable shades 6-8 and 9-13
- Externally adjustable delay
- Externally adjustable sensitivity
- External control knob for choosing weld/grind function
- Field of view 96 x 68.5 mm
- Classification 1/1/1/1
- MigADC<sup>plus</sup> Standard approved according to EN379, EN175, EN166
- MigADC<sup>plus</sup> Air approved according to EN379, EN175, EN166, EN12941, EN14594.

**Fields of application:**

- MMA (electrode)
- MIG/MAG
- TIG
- Grinding





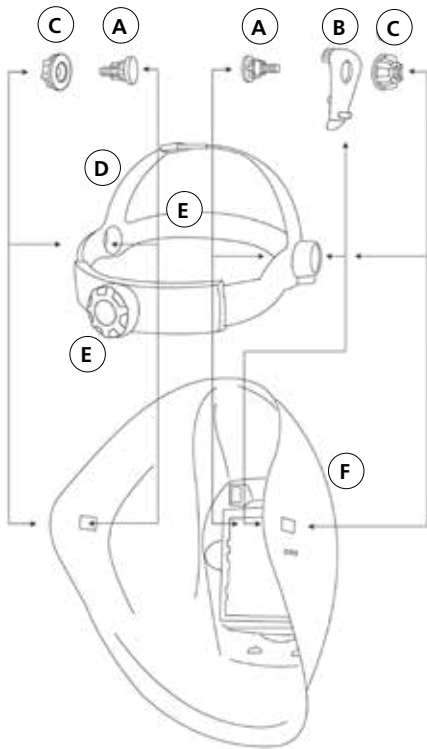

**MigADC<sup>plus</sup> Standard**

Art. no. 81910830

Welding helmet with fully-automatic filter (ADF). Externally variable shades 6-8 and 9-13. Externally adjustable delay and sensitivity plus weld/grind function. Perfect for demanding welding jobs in the manual and manufacturing industries. Approved according to EN379, EN175, EN166.

Pos.	Art. no.	Description
	81910830	MigADC <sup>plus</sup> Standard
A	81910846	Bolt for headgear
B	81910845	Brake for headgear
C	81910847	Nut for headgear
D	81910848	Headgear
E	81910844	Sweat frontlet
F	81910849	Helmet shell
G	81910841	Internal shielding glass 107.5 x 71.5 mm
H	81910850	Frame for magnification lenses
I	81911051 81911046 81911047 81911048	Magnification lenses +1.0 Magnification lenses +1.5 Magnification lenses +2.0 Magnification lenses +2.5
J	81910840	ADF Grand GDS Plus
K	81910842	External shielding glass 147 x 125 mm
L	81910843	Front frame
M	81910860	Hard hat
N	81910861	Adapter for mounting of hard hat

Parts for MigADC<sup>plus</sup> Standard and MigADC<sup>plus</sup> Air

**Hard hat**

For protection purposes, the Migatronic optical welding helmet can be equipped with a hard hat with brakes with built-in springs to keep it in place irrespective of welding position. The heavy-duty construction ensures long life of hard hat and adapter. If the welder stops welding, he can easily dismount the welding helmet, even with welding gloves on, and still be protected by the hard hat.

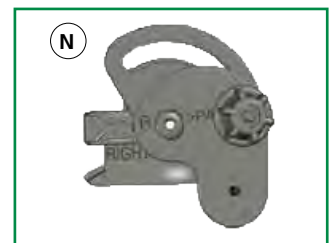
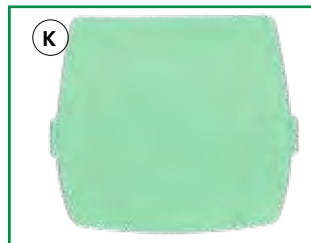
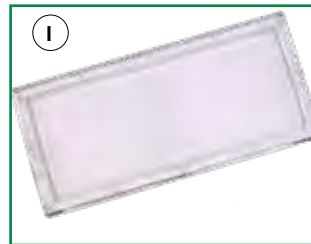
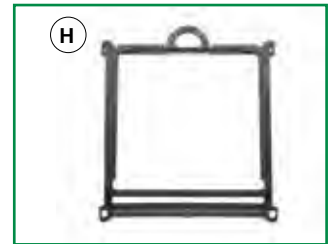
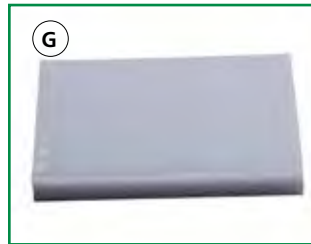

### Welding helmets with fresh air system

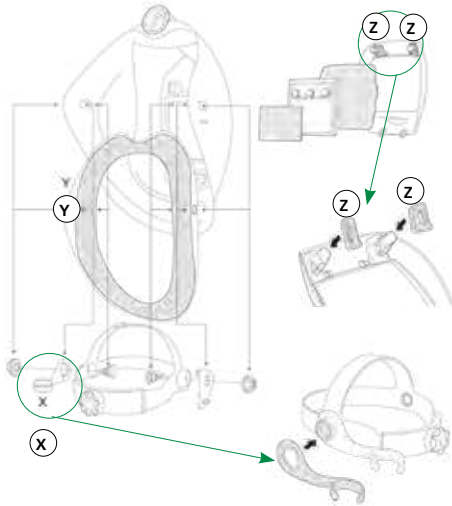

Pos.	Art. no.	Description
	81910835	MigADC <sup>plus</sup> Air
X	81910852	Hose holder
Y	81910851	Face seal

Parts for MigADC<sup>plus</sup> Air only.  
See other parts for MigADC<sup>plus</sup> Air page 8.

### MigADC<sup>plus</sup> Air

Art. no. 81910835

Welding helmet with fully-automatic filter (ADF), featuring the same control facilities and advantages as the MigADC<sup>plus</sup> Standard. The helmet can be fitted with a fresh-air unit. The integrated air duct with dampers allows the welder to adjust the air flow. Approved according to EN379, EN175, EN166, EN12941, EN14594.



MigADC<sup>plus</sup> Air with Basic Flow Control



Basic Flow Control



MigADC<sup>plus</sup> Air with Chemical 3F Flow Control and filter A2P3



Chemical 3F Flow Control

### Basic Flow Control

Art. no. 81910875

Motorised respiratory protection system with P3 particle filter. The unit is equipped with a micro-computer that enables a constant flow irrespective of battery size and no matter how much the filter is clogged up. The flow is adjustable from 170 to 240 l/min. Redesigned LED control panel makes all relevant details clearly visible to the welder. Approved according to EN12941/A2-TH3.

Art. no.	Description
81910875	Basic Flow Control
81910309	Prefilter
81910310	Particle filter P3
81910876	Battery
81910879	Air hose
81910878	Belt
81910877	Charger

### Chemical 3F Flow Control

Art. no. 81910880

New generation of motorised respiratory protection system, approved according to EN12941/TH2-TH3, EN12942/TM2-TM3 and density class IP65 for use in heavy chemical industries; designed to filter gases, vapours and particles and combinations thereof. The flow is adjustable from 120 to 235 l/min. If the flow falls to a low level or the filter is clogged up, the welder is warned by an alarm in the built-in micro-computer. The unit features a colour display and is supplied with a Li-Ion 14.4V 2.6Ah battery and a charger that charges the battery within 3 hours.

Art. no.	Description
81910880	Chemical 3F Flow Control
81910324	Combination filter A2P3
81910328	A2B2E2SXP3-OZONE combination filter
81910856	Battery
81910857	Hose
81910859	Belt
81910855	Charger

## Welding filters and magnification lenses

Welding glass Protection	Size mm				
	51 x 108 Art. no.	60 x 110 Art. no.	22 x 108 Art. no.	64 x 101 Art. no.	ø50 Art. no.
DIN 4			81911089		
DIN 5					81911037
DIN 6					81911038
DIN 7	81911081	81911082			
DIN 8	81911001	81911060			
DIN 9	81911007	81911059			
DIN 10	81911005	81911058			
DIN 11	81911008	81911057			
DIN 12	81911006	81911056			
DIN 13		81911055			
Clear shielding glass	81911002	81911054		81911061	81911035
Clear plexi glass	81911045	81911053	81911003		
Yellow plexi glass			81911087		
Green Plexi glass			81911004		

### Magnification lenses for welding helmets

Magnification lenses that suit most optical welding helmets e.g. Focus ADF and MigADC<sup>plus</sup> and non-optical welding helmets.



Art. no.	Diopter	Size mm
81911051	+1.0	51 x 108
81911046	+1.5	51 x 108
81911047	+2.0	51 x 108
81911048	+2.5	51 x 108

### Protection glasses for old models of optical Migatronic welding helmets



Art. no.	Size mm	Placement	Type of helmet
81910801	85,9 x 103,6	External	Focus green (second version)
81910802	53,7 x 104,8	Internal	Focus green (second version)
81910585	94,3 x 114,8	External	Focus black and green (first version)
81910586	53,4 x 105,7	Internal	Focus black and green (first version)
81910591	47 x 103,5	Internal	Protector ADF
81910106	51 x 107	Internal	Protector Three, 4,5/450/451, 5/500/501, 5Exclus.
81910107	97 x 110	External	Protector 4/400/401, 4,5/450/451, 5/500/501, 5TM/500TM/501TM, 5Exclus.
81910418	66 x 109	Internal	Protector 5/500/501
81911062	90 x 110	External	Protector 4/400/401, 5/500/501

## Shielding

A safe working place is a matter of common interest to both welders and their employers. Welders and others risk exposure to the harmful UV radiation as well as sparks and metal chips from welding, grinding and cutting. Migatron's approved shielding products reduce this risk considerably and provide optimal protection for everyone.

Migatron welding curtains are DIN approved and meet the requirements of EN 1598 and DIN 21404, part 2.

Migatron welding curtains and strip curtains protect against every kind of UV radiation up to 560 nm.

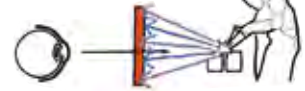

Migatron welding curtains and strip curtains carry EN-1598CE qualification and Migatron quality stamp.

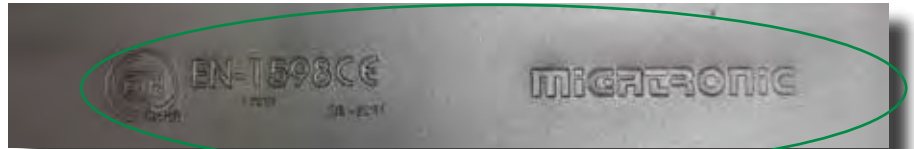

**Orange:**  
Shielding during arc welding



**Bronze:**  
Shielding during arc welding



**Green (non-transparent):**  
Shielding during arc welding

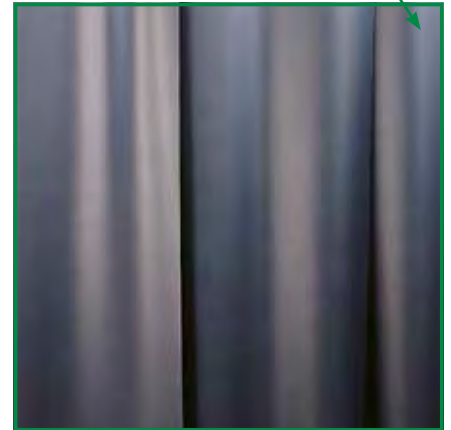

### Welding curtains

Separate curtains in standard sizes. Ring holes at 22 cm spacing at the top. Plastic snap fasteners welded on the sides. Supplied with 7 metal rings.

	Dull green Non-transparent	Orange Transparent	Bronze (Brown) Transparent
Height x width	Art. no.	Art. no.	Art. no.
1600 x 1400 mm	81910158	81910155	81910152
1800 x 1400 mm	81910159	81910156	81910153
2000 x 1400 mm	81910160	81910157	81910154

### Strip curtains

Design a welding cabin that suits today's requirements and redesign it tomorrow. Strip curtains with 1.0 mm thick strips are a simple and flexible solution. Large workpieces can easily be passed through the curtains, and in the case of damage it is enough to replace the damaged strip(s). Supplied in boxes of 4.



		Dull green Non-transparent	Orange Transparent	Bronze (Brown) Transparent
Height x width	Qty	Art. no.	Art. no.	Art. no.
1600 x 570 mm	4	81910163	81910166	81910169
2000 x 570 mm	4	81910165	81910168	81910171



**MOBILE WELDING CURTAIN DULL-GREEN**  
 Mobile, flexible welding curtain with 2 pivoting arms allows you to make either a booth or an extended curtain. The stand is supplied with 1.0 mm thick dull-green, non-transparent strips.

Width: 3750 mm.  
 Height: 2000 mm.

Art. no.....81910394



**MOBILE WELDING CURTAIN ORANGE**

Mobile, flexible welding curtain with 2 pivoting arms allows you to make either a booth or an extended curtain. The stand is supplied with 1.0 mm thick orange, non-transparent strips.

Width: 3750 mm.  
 Height: 2000 mm.

Art. no.....81910395



**WELDING CURTAIN GREEN INCL. STAND**  
 Mobile welding curtain incl. galvanised stand. Dull-green, non-transparent. Width 2000 mm. Height 2000 mm.

Art. no.....81910150



**WELDING CURTAIN ORANGE INCL. STAND**  
 Mobile welding curtain incl. galvanised stand. Orange, transparent. Width 2000 mm. Height 2000 mm.

Art. no.....81910151

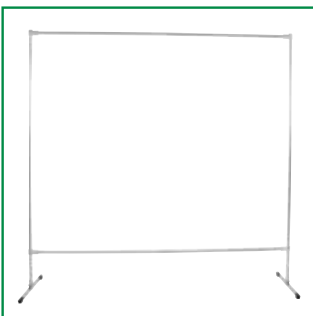

**SEPARATE STAND FOR MOBILE WELDING CURTAIN**  
 Galvanised stand for mobile welding curtain. Fits also 4 welding curtain strips size 1600 x 570 mm.

Art. no.....81910396



**METAL RING FOR CURTAINS**  
 Metal ring for mounting of welding curtains and strip curtains e.g. on galvanised stand.

Art. no.....81910210

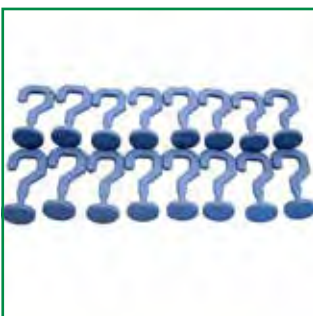

**PLASTIC HOOKS FOR SLIDING RAIL, PACKAGE OF 16**  
 Plastic hooks for mounting welding curtains and strip curtains in C-profile sliding rail.

Art. no.....81910211



**SLIDING RAIL C-PROFILE**  
 Galvanised sliding rail in C-profile. Measurement: 30 x 35 x 1.5 mm (max. 6 m).

Art. no.....81910356

## Build your personal welding cabin

Migatronc shielding elements allow you to design a welding cabin that suits your requirements.

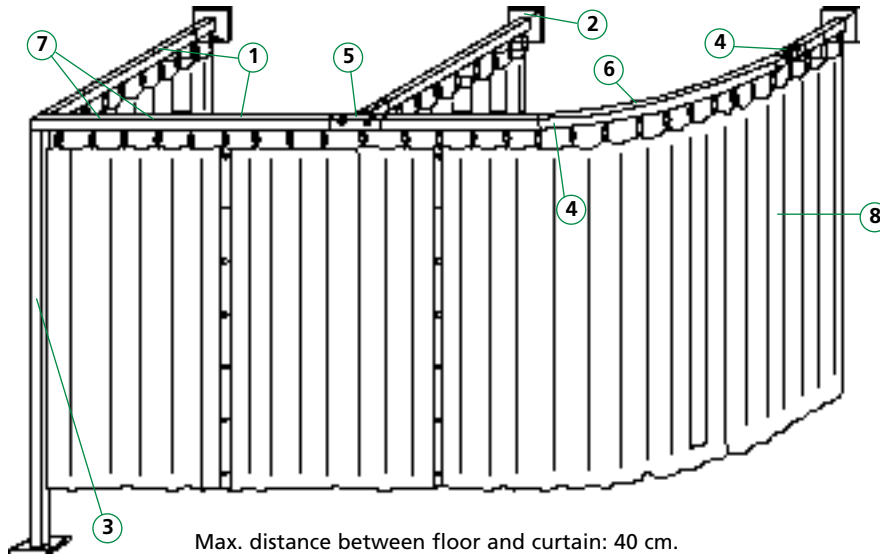

Pos.	Description	Art. no.
1	Sliding rail C-profile. Dimensions: 30 x 35 x 1.5 mm (max. 6 m)	81910356
2	Wall fittings for C-profile	81910241*
	Angle brace	81910350*
	Holder for C-profile	81910351*
3	Galvanized support with foot plate for C-profile	
	Height: 225 cm	81910353*
	Height: 285 cm	81910354*
4	Galvanized rail fittings for C-profile	81910357*
5	Galvanized T-piece connecting C-profiles	81910352*
6	Galvanized 90° bend, radius 500 mm for C-profile	81910355*
7	Plastic sliding rails for C-profile (16 pcs.)	81910211
8	Curtain, see page 12	

Your personal welding cabin can be pieced together of:

- made-to-measure curtains
- curtains with snap fasteners
- strip curtains

\* Please allow for extended delivery times.

## Welding blankets and fire blankets



### WELDING BLANKET KRONOS 2 X 1 M

Universal glass tissue welding blanket. Single-sided PU coating. Heat-resistant up to 550°C. Suitable for light welding and grinding.

Art. no.....81930060



### WELDING BLANKET KRONOS 2 X 2 M

Universal glass tissue welding blanket. Single-sided PU coating. Heat-resistant up to 550°C. Suitable for light welding and grinding.

Art. no.....81930061



### WELDING BLANKET KRONOS 25 X 1 M

Universal glass tissue welding blanket. Single-sided PU coating. Heat-resistant up to 550°C. Suitable for light welding and grinding.

Art. no.....81930062



### FIRE BLANKET 180 X 180 CM

Folded and packed in a red PVC bag with snap fasteners and Velcro fastener which provides easy access to the fire blanket in case of an accident.

Art. no.....81930048

**Tools**

A few tools make welders' work a lot easier. Professional Migatronik tools make it easy for welders to clean, check and make the finishing touches to workpieces.



**NOZZLE TONG Ø12-15 MM**  
Nozzle and wire cutter for cleaning ø12-15 mm gas nozzles as well as quick and correct wire cutting.

Art. no.....81940010



**NOZZLE TONG Ø15-18 MM**  
Nozzle and wire cutter for cleaning ø15-18 mm gas nozzles as well as quick and correct wire cutting.

Art. no.....81940011



**LARGE NOZZLE TONG**  
Nozzle and wire cutter for cleaning large gas nozzles as well as quick and correct wire cutting.

Art. no.....81940028

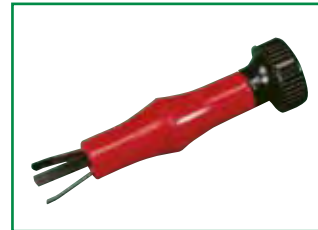

**GAS NOZZLE CLEANER**  
Gas nozzle cleaner with leaf springs for all types of gas nozzles. Removing weld spatter increases life of gas nozzles.

Art. no.....81940012



**MITRE MAGNET 1 X 300 KG**  
Mitre magnet for 30°, 45°, 60°, 75° and 90°. Retaining power 1 x 300 N.

Art. no.....81080003



**MITRE MAGNET 1 X 450 KG**  
Mitre magnet for 30°, 45°, 60°, 75° and 90°. Retaining power 1 x 450 N.

Art. no.....81080005



**CHIPPING HAMMER**  
Chipping hammer with metal handle. Weight 415 g.

Art. no.....81920003



**WIRE BRUSH FOR STAINLESS STEEL AND ALUMINIUM**  
Wire brush for cleaning stainless steel and aluminium workpieces.

Art. no.....81940020



**WELDING MIRROR WITH FLEXIBLE ARM**  
Welding mirror with flexible arm. Dimensions 70 x 80 x 1.5 mm.

Art. no.....81912202



**WELDING MIRROR WITH MAGNETIC FOOT AND FLEXIBLE ARM**  
Welding mirror with magnetic foot and flexible arm. Dimensions 70 x 80 x 1.5 mm.

Art. no.....81912201



**MIRROR 1.0 MM (10 PCS.)**  
Mirror for flexible arm. Dimensions 70 x 80 x 1.0 mm. Supplied in packages of 10.

Art. no.....81912204



**CLEANING NEEDLES SET**  
Cleaning needles set consisting of 1 file and 14 short cleaning needles in a metal box. Sizes from 0.4 to 2.5 mm. Use of cleaning needles increases the life of welding nozzles and cutting nozzles.

Art. no.....81970018

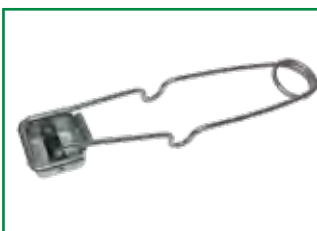

**D75/S80 GAS IGNITER**  
Gas igniter for igniting the gas torch; flexible and with replaceable ignite flint.

Art. no.....81970209



**IGNITE FLINT (5 PCS.)**  
Replaceable gas ignite flint for D75/S80 gas igniter. Supplied in packages of 5.

Art. no.....81970210

**Fume extraction**

Welding fume is highly hazardous to health and must be removed from the welding site and subsequently filtered in order to protect our environment. Migatronik takes pride in being as "green" as the welding machines we produce!



**MigaVent Mini \*)**

Portable, mobile high-vacuum filter unit for short-term welding and grinding assignments where high vacuum extraction is permitted. External air-cooling of motor. Supplied with easily replaceable dust class M filter. Transports up to 209 m³ air/hour. Supplied with ø 50 mm hose connection.

**Technical data:**

- Noise level: 73 dB (A)
- High-vacuum dust class M filter
- 1 x 230 V
- 1200 Watt
- ø50 mm connection
- Weight: 18.7 kg
- Dimensions (L x W x H): 370 x 350 x 534 mm

Art. no.....82031200

\*) Additional schuko plug is required



**MOUTH PIECE 200 MM Ø50 MM**  
200 mm slot nozzle with steel hose and magnet for mounting on 51 mm flex hose.

Art. no.....82031201



**MOUTH PIECE 300 MM Ø50 MM**  
300 mm slot nozzle with magnet for mounting on 51 mm flex hose.

Art. no.....82031202



**MOUTH PIECE ROUND Ø50 MM**  
Conic extraction mouthpiece with steel hose and magnet for mounting on 51 mm flex hose.

Art. no.....82031203



**FILTER FOR MIGAVENT MINI**  
Fire-resistant filter cartridge for MigaVent Mini

Art. no.....82031205



**ADAPTER FOR HOSE 50 MM <=> 45 MM**  
Adapter to connect a 50 mm connection to a 45 mm hose and a 45 mm connection to a 50 mm hose.

Art. no.....82031206



**EXTRACTION HOSE**  
Flex extraction hose for MigaVent Mini and mouthpiece in running metre. Inside diameter ø 51 mm. Art. no.....92570042

Flex extraction hose for MigAir and mouthpiece in running metre. Inside diameter ø 45 mm. Art. no.....92570041





**MigaVent 2000<sup>\*)</sup>**

Ventilator for wall-mounting with energy-saving engine. MigaVent 2000 transports up to 1.300 m<sup>3</sup> air/h.

**Technical data:**

- 3 x 400 V
- 50 Hz
- 2780 revolutions/minute
- 1.10 kW
- ø160 mm connection

Art. no.....82031230

<sup>\*)</sup> Additional schuko plug is required



**FLEXI EXTRACTION ARM 3 M**

3 m extraction arm with swivel link, extraction hood with damper and gas springs. Ø 160 mm hose connection.

Art. no.....82031231

**FLEXI EXTRACTION ARM 4 M**

4 m extraction arm with swivel link, extraction hood with damper and gas springs. Ø 160 mm hose connection.

Art. no.....82031232



**PRESSURE GUARD**

Pressure guard for MigaVent 2000 and Flexi extraction arm. Red warning light is lit in case of insufficient extraction.

Art. no.....82031233

## Tungsten grinding

Trouble-free TIG welding requires a correctly-ground Tungsten electrode. Migatronik Tungsten grinders provide correctly-ground Tungsten electrodes for perfect TIG welding results and reduce the consumption of electrodes to a minimum for the benefit of the environment.



*Migatronik also offers a wide range of high-quality tungsten electrodes and recommends our allround Super Blue™ with excellent ignition and reignition properties for improved welding quality and safety; the optimal choice for DC and AC welding in all types of material.*



### Green Pointer X2

Handy, portable tungsten grinder for perfect and eco-friendly grinding of 1.0-4.0 mm tungsten electrodes; including exhaust with easily replaceable filter and excenter disc for triple utilisation of diamond disc. Green Pointer X2 is supplied in a transport case complete with diamond grinding disc, electrode holder and electrode clamps for 1.6, 2.4 and 3.2 mm electrodes.

Green Pointer X2 with schuko plug  
Art. no.....82036170



**ELECTRODE CLAMPS**  
Electrode clamps for Green Pointer X2, Pro and Pro Cut

- Art. no.: ø1.0 mm.....82036173
- Art. no.: ø1.6 mm.....82036174
- Art. no.: ø2.0 mm.....82036175
- Art. no.: ø2.4 mm.....82036176
- Art. no.: ø3.2 mm.....82036177
- Art. no.: ø4.0 mm.....82036178



**DIAMOND GRINDING DISC GREEN POINTER X2**  
Diamond grinding disc for Green Pointer X2 Ø 40 mm.

Art. no.....82036171



**ELECTRODE HOLDER GREEN POINTER X2**  
Electrode holder for Green Pointer X2

Art. no.....82036172



**FILTER CASSETTE GREEN POINTER X2**  
Filter cassette for collection of grinding dust in Green Pointer X2.

Art. no.....82036179



**TABLE CONSOLE GREEN POINTER X2**  
Solid console for fixing the Green Pointer X2 to a table during grinding.

Art. no.....82036185



**SIGHT GLASS GREEN POINTER X2**  
Sight glass for Green Pointer X2

Art. no.....82036186



**Green Pointer Pro**

Tungsten wet grinder for grinding 0.8-4.0 mm tungsten electrodes, featuring eco-friendly collection of toxic dust particles. Cold wet grinding combined with high grinding speed provide at smooth surface of the tungsten electrode. Green Pointer Pro ensures correctly-ground tungsten electrodes for trouble-free TIG welding and is supplied complete with console, diamond grinding disc, grinding liquid, electrode holder and electrode clamps for 1.6, 2.4 and 3.2 mm electrodes.

Art. no.....82036220

**Green Pointer Pro Cut**

Tungsten wet grinding and cutting device for perfect and eco-friendly grinding and cutting 0.8-4.0 mm tungsten electrodes. Green Pointer Pro Cut grinds the electrode tips in exact angles and lengths for TIG welding operations, including robot and orbital welding, and is supplied complete with console, diamond grinding disc, grinding liquid, electrode holder and electrode clamps for 1.6, 2.4 and 3.2 mm electrodes.

Art. no.....82036230



**ELECTRODE HOLDER  
GREEN POINTER PRO/PRO CUT**  
Electrode holder for Green Pointer Pro and Pro Cut complete with handle and union nut.

Art. no.....82036208



**ELECTRODE CLAMPS**  
Electrode clamps for Green Pointer X2, Pro and Pro Cut  
Art. no.: ø1.0 mm.....82036173  
Art. no.: ø1.6 mm.....82036174  
Art. no.: ø2.0 mm.....82036175  
Art. no.: ø2.4 mm.....82036176  
Art. no.: ø3.2 mm.....82036177  
Art. no.: ø4.0 mm.....82036178



**DIAMOND GRINDING DISC  
GREEN POINTER PRO/PRO CUT**  
Diamond grinding disc for Green Pointer Pro and Pro Cut

Art. no.....82036210



**GRINDING LIQUID CONTAINER \***  
Container with cooling/lubricating liquid for tungsten wet grinders Green Pointer Pro, Pro Cut, MK1, MK2. The container collects heavy metals in the grinding particles.

Art. no.....82036132



**GRINDING LIQUID \***  
Special cooling/lubricating liquid in 250 ml bottles for tungsten wet grinders.

Art. no.....82036103



**GRINDING LIQUID \***  
Grinding liquid in 5 l cans for tungsten wet grinders.

Art. no.....82036125

\* Used liquid is to be disposed of at your local hazardous waste disposal site.

**Pressure regulators**

**A high rate of return for quite a modest investment!** Migatronic pressure regulators with incorporated gas saver function will allow you to save up to 50% of your gas consumption. Pressure regulators will also help you to monitor the amount of gas in the cylinder and prevent you from running out of gas during welding.



**CO<sub>2</sub> PRESSURE REGULATOR  
2 MANOMETERS**  
High-quality and high-capacity CO<sub>2</sub> pressure regulator. Max. 200 bar primary pressure. Equipped with manometer for gas flow read-out. Operating range: 0-35 l/min. Inlet thread: W21.8x14/1" Outlet thread: G3/8"

Art. no.....81963034



**CO<sub>2</sub> PRESSURE REGULATOR  
2 MANOMETERS**  
High-quality and high-capacity Argon/mix pressure regulator. Max. 200 bar primary pressure. Equipped with manometer for gas flow read-out. Operating range: 0-35 l/min. Inlet thread: R3/4" Outlet thread: G3/8"

Art. no.....81963035



**ARGON/MIX PRESSURE  
REGULATOR 2 MANOMETERS**  
High-quality and high-capacity Argon/mix pressure regulator. Max. 200 bar primary pressure. Equipped with manometer for gas flow read-out. Operating range: 0-35 l/min. Inlet thread: W24.32x14/1" Outlet thread: G3/8"

Art. no.....81963038



**ARGON/MIX PRESSURE  
REGULATOR 2 MANOMETERS**  
High-quality and high-capacity Argon/mix pressure regulator. Max. 200 bar primary pressure. Equipped with manometer for gas flow read-out. Operating range: 0-35 l/min. Inlet thread: W24,52ext Outlet thread: G3/8"

Art. no.....81963004



**ARGON/MIX PRESSURE  
REGULATOR 2 MANOMETERS**  
High-quality and high-capacity CO<sub>2</sub> pressure regulator. Max. 200 bar primary pressure. With manometer for gas flow read-out. Operating range: 0-35 l/min. Inlet thread: W21,8x14/1" Outlet thread: G1/4"

Art. no.....81963348



**ARGON/MIX PRESSURE  
REGULATOR 2 MANOMETERS**  
High-quality and high-capacity Argon/mix pressure regulator. Max. 200 bar primary pressure. With manometer for gas flow read-out. Operating range: 0-35 l/min. Inlet thread: W21,8x14/1" Outlet thread: M12x1

Art. no.....81963347



**FORMIER/H<sub>2</sub> PRESSURE  
REGULATOR 2 MANOMETERS**  
High-quality and high-capacity-pressure regulator for formier or H<sub>2</sub>.Max. 200 bar primary pressure. With manometer for gas flow read-out. Operating range: 0-16 bar Capacity: 30 m<sup>3</sup>/h Inlet thread: W21,8x14/1" LH Outlet thread: G3/8" LH

Art. no.....81963068



**ARGON/MIX REGULATOR  
2 MANOMETERS BOTTOM  
CONNECTION**  
High-quality and high-capacity Argon/mix pressure regulator. Max. 200 bar primary pressure. With manometer for gas flow read-out. Operating range: 0-35 l/min. Inlet thread: G5/8"ext Outlet thread: G3/8"

Art. no.....81963346



**ACETYLENE PRESSURE REGU-  
LATOR 2 MANOMETERS**  
High-quality and high-capacity pressure regulator for acetylene. Max. 40 bar primary pressure. With manometer for gas flow read-out. Operating range: 0-4 bar Capacity: 5 m<sup>3</sup>/h Inlet thread: G3/4"ext Outlet thread: G3/8" LH

Art. no.....81963065



**OXYGEN PRESSURE  
REGULATOR 2 MANOMETERS**  
High-quality and high-capacity pressure regulator for oxygen. Max. 200 bar primary pressure. With manometer for gas flow read-out. Operating range: 0-16 bar Capacity: 30 m<sup>3</sup>/h Inlet thread: W21.8x14/1" Outlet thread: G3/8"

Art. no.....81963066

Migatronics offers a wide range of pressure regulators, including pressure regulators for central systems.



**ARGON/MIX OPTIMATOR  
1 FLOWMETER**  
Argon/mix Optimator with built-in gas saver. Gas consumption can be reduced by up to 50%. Result = fewer replacements of gas cylinders and improved production efficiency.  
Inlet thread: W24.32x14/1"  
Outlet thread: G3/8"  
Art. no.....81963041



**ARGON/MIX OPTIMATOR  
1 FLOWMETER**  
Argon/mix Optimator with built-in gas saver. Gas consumption can be reduced by up to 50%. Result = fewer replacements of gas cylinders and improved production efficiency.  
Inlet thread: W24,5x14/1"  
Outlet thread: G3/8"  
Art. no.....81963324



**ARGON/MIX OPTIMATOR  
1 FLOWMETER**  
Argon/mix Optimator with built-in gas saver. Gas consumption can be reduced by up to 50%. Result = fewer replacements of gas cylinders and improved production efficiency.  
Inlet thread: W21,8x14/1"  
Outlet thread: G1/4"  
Art. no.....81963047



**ARGON/MIX OPTIMATOR  
1 FLOWMETER**  
Argon/mix Optimator with built-in gas saver. Gas consumption can be reduced by up to 50%. Result = fewer replacements of gas cylinders and improved production efficiency.  
Inlet thread: W21,8x14/1"  
Outlet thread: M12x1  
Art. no.....81963315



**ARGON/MIX OPTIMATOR  
1 FLOWMETER BOTTOM  
CONNECTION**  
Argon/mix Optimator with built-in gas saver. Gas consumption can be reduced by up to 50%. Result = fewer replacements of gas cylinders and improved production efficiency.  
Inlet thread: G5/8"ext  
Outlet thread: G3/8"  
Art. no.....81963080



**ARGON/MIX OPTIMATOR  
1 FLOWMETER**  
Argon/mix Optimator with built-in gas saver. Gas consumption can be reduced by up to 50%. Result = fewer replacements of gas cylinders and improved production efficiency.  
Inlet thread: G5/8" Side Entry  
Outlet thread: G3/8"  
Art. no.....81963081



**ARGON/MIX OPTIMATOR  
1 FLOWMETER**  
Argon/mix Optimator with built-in gas saver. Gas consumption can be reduced by up to 50%. Result = fewer replacements of gas cylinders and improved production efficiency.  
Inlet thread: W21,8x14/1"  
Outlet thread: G3/8"  
Art. no.....81963309



**ARGON/H2 OPTIMATOR  
1 FLOWMETER**  
Argon/H2 Optimator with built-in gas saver. Gas consumption can be reduced by up to 50%. Result = fewer replacements of gas cylinders and improved production efficiency.  
Inlet thread: W21,8x14/1" LH  
Outlet thread: G3/8" LH  
Art. no.....81963048



**ARGON/MIX OPTIMATOR  
2 FLOWMETRES**  
Argon/mix Optimator with 2 flowmetres. Used for shielding gas and back-up gas from the same gas cylinder. Equipped with gas saver. Gas consumption can be reduced by up to 50%.  
Inlet thread: W21,8x14/1"  
Outlet thread: G1/4"  
Art. no.....81963050

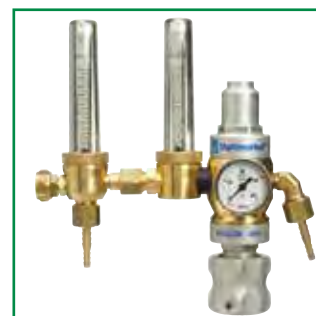

**ARGON/H2 OPTIMATOR  
2 FLOWMETRES**  
Argon/H2 Optimator with 2 flowmetres. Used for shielding gas and back-up gas from the same gas cylinder. Equipped with gas saver. Gas consumption can be reduced by up to 50%.  
Inlet thread: W21,8x14/1" LH  
Outlet thread: G3/8" LH  
Art. no.....81963051



**ARGON/MIX PRESSURE REGULATOR 1 FLOWMETER**  
 High-quality and high-capacity Argon/mix pressure regulator. Max. 200 bar primary pressure. Equipped with flowmeter for gas flow read-out.  
 Operating range: 0-35 l/min.  
 Inlet thread: W24.32x14/1"  
 Outlet thread: G3/8"

Art. no.....81963055



**ARGON/MIX PRESSURE REGULATOR 1 FLOWMETER**  
 High-quality and high-capacity Argon/mix pressure regulator. Max. 200 bar primary pressure. With flowmeter for gas flow read-out.  
 Operating range: 0-34 l/min.  
 Inlet thread: W24,5x14/1"  
 Outlet thread: G3/8"

Art. no.....81963320



**ARGON/MIX PRESSURE REGULATOR 1 FLOWMETER**  
 High-quality and high-capacity Argon/mix pressure regulator. Max. 200 bar primary pressure. With flowmeter for gas flow read-out.  
 Operating range: 0-34 l/min.  
 Inlet thread: W21,8x14/1"  
 Outlet thread: G1/4"

Art. no.....81963097



**FORMIER PRESSURE REGULATOR 1 FLOWMETER**  
 High-quality and high-capacity Former pressure regulator. Max. 200 bar primary pressure. With flowmeter for gas flow read-out.  
 Operating range: 0-34 l/min.  
 Inlet thread: W21.8x14/1" LH  
 Outlet thread: G3/8" LH

Art. no.....81963067



**ARGON/MIX PRESSURE REGULATOR 2 FLOWMETRES**  
 Argon/mix pressure regulator. Max. 200 bar primary pressure. With 2 flowmetres for gas flow read-out. Used for shielding gas and back-up gas from the same gas cylinder.  
 Operating range: 0-34 l/min.  
 Inlet thread: W24.32x14/1"  
 Outlet thread: G3/8"

Art. no.....81963057



**OPTIMATOR TAP UNIT 1 FLOWMETER**  
 Optimator tap unit with built-in gas-saver. For mounting on stop valves at the welding spot in central systems. Flowmeter with operating range: 0-35 l/min.  
 Inlet thread: G3/8"  
 Outlet thread: G3/8"

Art. no.....81963045



**OPTIMATOR TAP UNIT LOCKABLE 1 FLOWMETER**  
 Lockable Optimator tap unit for Argon with built-in gas-saver. For mounting on stop valves at the welding spot in central systems. Flowmeter with operating range: 0-35 l/min.  
 Inlet thread: G3/8"  
 Outlet thread: G3/8"

Art. no.....81963327



**OPTIMATOR TAP UNIT 1 FLOWMETER**  
 Optimator tap unit with built-in gas-saver. For mounting on stop valves at the welding spot in central systems. Flowmeter with operating range: 0-35 l/min.  
 Inlet thread: G3/8"  
 Outlet thread: G1/4"

Art. no.....81963052



**AR/MIX OPTIMATOR FOR RETROFITTING**  
 Argon/mix Optimator gas-saver. For retrofitting on ordinary pressure regulators or tap units.  
 Inlet thread: G3/8"  
 Outlet thread: G3/8"

Art. no.....81963054



**OPTIMATOR ALTOP**  
 Argon/mix gas saver equipped with quick-release fittings for Altop. Mounting on Altop cylinder does not require additional fittings.

Art. no.....81963316



**WALL FITTING FOR TAP UNIT**  
Wall fitting for mounting of stop valves for tap units.

Art. no.....81963130



**ANGLE PIECE FOR TAP UNIT**  
Angle piece for mounting tap units. Thread: G3/8"

Art. no.....81963131



**T-PIECE FOR TWIN TAP UNIT**  
T-piece for mounting of twin tap unit. Thread: G3/8"

Art. no.....81963132



**STOP VALVE FOR TAP UNIT**  
Stop valve for mounting between central system and tap unit. Thread: G3/8"

Art. no.....81963133



**LOW-PRESSURE MANOMETER ACETYLENE**  
Low-pressure 0-4 bar manometer. Spare part for Migatron acetylene pressure regulator.

Art. no.....81963140



**HIGH-PRESSURE MANOMETER ACETYLENE**  
High-pressure 0-40 bar manometer. Spare part for Migatron acetylene pressure regulator.

Art. no.....81963141



**HIGH-PRESSURE MANOMETER CO<sub>2</sub> AND ARGON/MIX**  
High-pressure 0-315 bar manometer. Spare part for Migatron CO<sub>2</sub> and Argon/mix pressure regulator.

Art. no.....81963144



**LOW-PRESSURE MANOMETER CO<sub>2</sub> AND ARGON/MIX**  
Low pressure manometer. 0-35 l/min. Spare part for Migatron CO<sub>2</sub> and Argon/mix pressure regulators.

Art. no.....81963145



**LOW-PRESSURE MANOMETER OXYGEN**  
Low pressure manometer 0-16 bar. Spare part for Migatron oxygen pressure regulator.

Art. no.....81963165



**HIGH-PRESSURE MANOMETER OPTIMATOR**  
High-pressure manometer 0-315 bar. Spare part for Migatron Optimators.

Art. no.....81963127



**FLOWMETER TUBE EXTERIOR**  
Exterior tube for flowmeter tube. For pressure regulators with swivel nut, new model.

Art. no.....81963137



**FLOWMETER TUBE COMPLETE**  
Complete flowmeter tube. For pressure regulators with swivel nut, new model.

Art. no.....81963138



**FLOWMETER TUBE COMPLETE**  
Complete flowmeter tube 0-34 l/min. External thread in protective glass. For old models.

Art. no.....81963128



**FLOWMETER TUBE EXTERIOR**  
Exterior tube for flowmeter tube. Exterior thread in glass. For old models.

Art. no.....81963173

**FLOWMETER**

Flowmeter for control of the actual gas flow in the gas nozzle.

Art. no.....81010000

**TWIN OUTLET FOR PRESSURE REGULATOR**

For two outlets on one Migatronc argon or oxygen pressure regulator with G3/8" thread.

Art. no.....81963149

**HOSE NIPPLE WITH SWIVEL NUT 1/4"**

Hose nipple with swivel nut. Spare part for Migatronc pressure regulators with G1/4" outlet thread.

Art. no.....81963146

**HOSE NIPPLE WITH SWIVEL NUT 3/8"**

Hose nipple with swivel nut. Spare part for Migatronc pressure regulators with G3/8" outlet thread.

Art. no.....81963147

**SWIVEL NUT GASKETS ARGON/MIX**

Swivel nut gaskets in packages of 5 for argon/mix pressure regulators.

Art. no.....81963129

**SWIVEL NUT GASKET ACETYLENE**

Swivel nut gaskets in packages of five for acetylene pressure regulators.

Art. no.....81963139

**FLASHBACK ARRESTOR OXYGEN**

Non-resetable flashback arrestor for oxygen which stops and extinguishes backfire. Equipped with safety fuse that shuts off the gas flow in case of overheating.

Art. no.....81963120

**FLASHBACK ARRESTOR ACETYLENE**

Non-resetable flashback arrestor for acetylene which stops and extinguishes backfire. Equipped with safety fuse that shuts off the gas flow in case of overheating.

Art. no.....81963121

**GAS PRE-HEATER CO<sub>2</sub> 220V**

Gas pre-heater for CO<sub>2</sub> to be placed between cylinder and pressure regulator. Prevents cooling of the pressure regulator in case of large gas flows. Max. flow: 1200 l/hour

Art. no.....81960048



**Starter kits, wearing parts boxes etc.**

Once you have invested in a Migatronix welding machine, you also need filler materials and wearing parts. Starter kits help you get started and save money on your total purchase amount.



**STARTER KIT, STAINLESS**  
 Starter kit for 0.8 mm stainless steel. Applicable for transformer-based Automig welding machines with 2-roll wire feed system. Supplied with 15 kg welding wire, pressure regulator, wire rolls kit and liner.

Art. no.....81100121



**STARTER KIT, ALUMINIUM**  
 Starter kit for 1.0 mm aluminium. Applicable for transformer-based Automig welding machines with 2-roll wire feed system. Supplied with 6 kg welding wire, pressure regulator, wire rolls kit, liner and contact tips.

Art. no.....81100120



**TORCH PROTECTOR**  
 The torch protector protects torch and central connection on the welding machine against impacts and collisions. For mounting on Migatronix MIG/MAG welding machines with central connection.

Art.no..... 78861400



**ADAPTER FOR 5KG WIRE ROLL**  
 Adaptor for use on the wire hub of the welding machine along with 5 kg/D200 wire spools.

Art. no..... 45050333



**PLASTIC ADAPTER**  
 Plastic wire adaptor for switch-over between plastic spools (D300) and metal spools (K300).

Art. no..... 81899017



**K4000 GOUGING TORCH**  
 Gouging torch complete with cable. Total length 220 cm. Classified to 1000 amps. In addition to gouging electrodes, use compressed air along with the hose.

Art. no..... 81899001



**GOUGING ELECTRODES**  
 Gouging electrodes, 5 x 305 mm. Art. no..... 81899005  
 Gouging electrodes, 6 x 305 mm. Art. no..... 81899006  
 Gouging electrodes, 8 x 305 mm. Art. no..... 81899008  
 Gouging electrode. 9.5 x 305 mm. Art. no.....81899010  
 Gouging electrode. 12.7 x 305 mm. Art. no..... 81899013

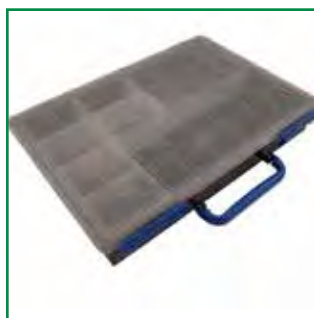

**WEARING PARTS BOX WITH INSERTS**  
 Wearing parts box with inserts, exclusive of wearing parts. Ideal for storing wearing parts for welding torches.

TIG  
 Art. no.....81100210

MIG  
 Art. no.....81100211

**WEARING PARTS BOXES**

Wearing parts boxes with inserts, including wearing parts. Ideal for storing wearing parts for welding torches.



**ML150B steel 0.6-0.8 mm**  
 Art. no.....81100222

**ML150 steel 0.8 mm**  
 Art. no.....81100223

**ML250 steel 0.8-1.0 mm**  
 Art. no.....81100224

**ML/MV240 steel 0.6-0.8 mm**  
 Art. no.....81100214

**ML/MV240 steel 1.0 mm**  
 Art. no.....81100231

**ML300 steel 1.0 mm**  
 Art. no.....81100232

**MV450/550 steel 1.0-1.2 mm**  
 Art. no.....81100216

**MV400 FKS steel 1.0-1.2 mm**  
 Art. no.....81100236

**MV500 FKS steel 1.0-1.2 mm**  
 Art. no.....81100237

**TIG 101/301/321 1.6-2.4 mm**  
 Art. no.....81100228

**TIG 101/301/321 2.4-3.2 mm**  
 Art. no.....81100248

**TIG 201/221/401 1.6-2.4 mm**  
 Art. no.....81100230

**TIG WP24/DSF225 1.6-2.4 mm**  
 Art. no.....81100238

**ZETA 60**  
 Art. no.....81100233

**ZETA 100**  
 Art. no.....81100239

**Chemicals**

Migatronic's chemical products support optimal welding results and comply with the requirements of the law for storage and documentation. 16-point safety data sheets can be downloaded at [migatronic.com](http://migatronic.com).



**MIG WELDING LIQUID, 10 L**  
Approved for galvanising without extra cleaning. Prevents weld spatter on workpiece and gas nozzle which reduces the need for maintenance of the welding equipment. Concentrated liquid: do not overdose. Supplied in 10 liter cans.

Art.no.....81950034



**MIG SPRAY 25 KG SILICONE-FREE**  
Silicone-free MIG spray refill. Supplied in 25 kg cans.

Art.no.....81950028



**MIG PASTE 300 G**  
Welding and protection paste. Protects gas nozzles against spatter. Made of purely natural products. Silicone-free. Supplied in 300 g cans.

Art.no.....81950026



**MIGALUBE 50 ML**  
Dirt-proof, dust-proof and water-resistant dry lubricant for cleaning of Migatronic plastic feed rolls. The lubricant provides a protective non-drip coating that minimises wear of the movable parts.

Art.no.....99150000



**CONCENTRATED COOLANT**  
Concentrated coolant for frost-proofing below -12° C. Supplied in 1 litre cans.

Ratio:  
Temperature / Add concentrate per litre ready-mixed coolant  
-21° C / 1 dl  
-24° C / 2 dl  
-27° C / 3 dl

Art.no.....99290508



**GREEN COOLANT 5 LITRES -12° C**  
Eco-friendly coolant for water-cooled welding machines. Frost-proof down to -12°C. Supplied in 5 litre cans. Use of correct coolant ensures longer life of the welding machine.

Art.no.....99290506

**Protect your back! Use Miga-Lift and avoid heavy lifting.**

**MIGA-LIFT**

Specially designed robust trolley with large rubber wheels for safe transport of gas cylinders. Use the turning handle to lift the gas cylinder and lower it onto the welding machine. The Miga-Lift is equipped with a self-locking turning mechanism which locks and lifts the gas cylinder in one operation.  
Art. no..... 70619800



## Original spare parts

Original MigatroniC spare parts ensure correct maintenance and long life of your welding equipment. Below you will find a small selection of our original spare parts. For other recommended spare parts, please refer to spare parts lists/manuals at migatroniC.com.

### Multi plugs, dinse plugs, earth clamps and electrode holders



#### MULTI PLUG 6-POLE

- 1. Multi plug, female:  
Art. no..... 17200001
- 2. Multi plug, male:  
Art. no..... 17210001
- 3. Multiplug housing (plastic)  
for mounting on machine  
Art. no..... 18200002

- 4. Multiplug housing (metal)  
for mounting on hose  
Art. no..... 18200101
- 5. Multiplug housing (metal)  
for mounting on machine  
Art. no..... 18200102
- 6. Extension for metal multiplug  
housing for mounting on hose  
Art. no..... 18200103

- 7. Junction box (metal):  
Art. no..... 74348002
- MULTI PLUG 8-POLE**
- 8. Multi plug, female:  
Art. no..... 17200023
- 9. Multi plug, male:  
Art. no..... 17210024

#### MULTI PLUG 19-POLE

- 11. Multi plug, male:  
Art. no..... 17210026

#### MULTI PLUG 4-POLE

- 12. Multi plug, female:  
Art. no..... 17200030

- 13. Multi plug, male:  
Art. no..... 17210030

#### MULTI PLUG 7-POLE

- 14. Multi plug, female:  
Art. no..... 17200056

- 15. Multi plug, male:  
Art. no..... 17210057



#### DINSE PLUG, MALE

- 10-25 mm<sup>2</sup> ø10  
Art. no..... 18120006
- 35-50 mm<sup>2</sup> ø13  
Art. no..... 18120002
- 50-70 mm<sup>2</sup> ø13  
Art. no..... 18120003
- 70-95 mm<sup>2</sup> ø13  
Art. no..... 18120004

#### DINSE COUPLING SOCKET, FEMALE

- 10-25 mm<sup>2</sup> ø10  
Art. no..... 18110001
- 35-50 mm<sup>2</sup> ø13  
Art. no..... 18110002
- 50-70 mm<sup>2</sup> ø13  
Art. no..... 18110003

#### CURRENT CABLE EXTENSION, FEMALE

- 10-25 mm<sup>2</sup> ø10  
Art. no..... 18110101
- 35-50 mm<sup>2</sup> ø13  
Art. no..... 18110102
- 70-95 mm<sup>2</sup> ø13  
Art. no..... 18110103



#### MMA ELECTRODE HOLDER

Fully isolating rubber cap. 2 pos. welding angle 45° or 90°. Optimal current transfer. Screw type for optimal electrode grip.

- 200 A Art. no..... 80550010
- 450 A Art. no..... 80550009
- 600 A Art. no..... 80550008

#### MMA ELECTRODE HOLDER "ALLIGATOR CLIP"

- 300 A Art. no..... 80550037
- 400 A Art. no..... 80550035
- 600 A Art. no..... 80550036
- 200 A Art. no..... 80550038



#### SPARE HEAD FOR MMA ELECTRODE HOLDER

- 45/90° 200 A  
Art. no..... 80550027
- 45/90° 450 og 600 A  
Art. no..... 80550028

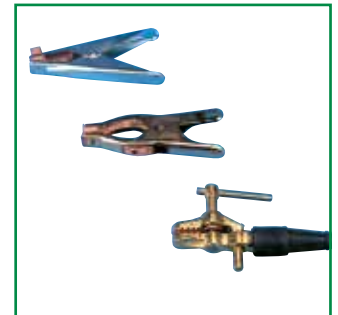

#### EARTH CLAMP

- 250 A Art. no..... 80560010
- 400 A Art. no..... 80560011
- 500 A Art. no..... 80560012

#### EARTH CLIP

- 200 A Nevada 200  
Art. no..... 80560001

#### 300 A Nevada 350

- Art. no..... 80560002

#### SCREW EARTH CLAMP

- 600 A  
Art. no..... 80560009

# MIGATRONIC WORLDWIDE

[www.migatronic.fi](http://www.migatronic.fi)  
[www.migatronic.no](http://www.migatronic.no)  
[www.migatronic.se](http://www.migatronic.se)  
[www.migatronic.dk](http://www.migatronic.dk)  
[www.migatronic.co.uk](http://www.migatronic.co.uk)  
[www.migatronic.nl](http://www.migatronic.nl)  
[www.migatronic.de](http://www.migatronic.de)  
[www.migatronic.cz](http://www.migatronic.cz)  
[www.migatronic.fr](http://www.migatronic.fr)  
[www.migatronic.it](http://www.migatronic.it)  
[www.migatronic.hu](http://www.migatronic.hu)  
[www.migatronic.in](http://www.migatronic.in)  
[www.migatronic.cn](http://www.migatronic.cn)

[www.migatronic.com](http://www.migatronic.com)

**Migatronic A/S**  
Aggersundvej 33  
DK-9690 Fjerritslev, Danmark  
Tel: (+45) 96 500 600  
Telefax: (+45) 96 500 601  
[migatronic.com](http://migatronic.com)

52170004 (01.01.2019)

